Villa Health

Product Specifications	690
Fabrics and Options	691
Product Pages	693
COM Yardage Requirements	702

VILLA HEALTH PRODUCT SPECIFICATIONS

MOBILE LOUNGE CHAIRS

- Clean out
- 123mm dual wheel casters on front: black
- Non-skid, adjustable glides on back legs
- Rounded handle on back: platinum metallic finish
- EOS^{CU} (Cupron-enhanced EOS) biocidal solid surface arm caps
- Power/USB grommet
- Legs: metal square, round, Y, or wood tapered

MOBILE LOUNGE CHAIRS WITH TABLET ARM

- Clean out
- 123mm dual wheel casters on front: black
- Non-skid, adjustable glides on back legs
- Rounded handle on back: platinum metallic finish
- Tablet arm: HPL or wood
- Tablet arm grommet (NH) to enable tablet arm to be moved to the other arm by user
- Power/USB grommet
- Legs: metal square, round, Y, or wood tapered

LOUNGE CHAIRS, LOVESEATS, SOFAS

- Clean out
- Non-skid, adjustable glides on legs
- EOS^{CU} (Cupron-enhanced EOS) biocidal solid surface arm caps
- Power/USB grommet
- Legs: metal square, round, Y, or wood tapered

LOUNGE CHAIRS, LOVESEATS, SOFAS WITH TABLET ARM

- Clean out
- Non-skid, adjustable glides on legs
- Tablet arm: HPL or wood
- Tablet arm grommet (NH) to enable tablet arm to be moved to the other arm by user
- Power/USB grommet
- Legs: metal square, round, Y, or wood tapered

45° CRESCENT LOUNGE

- Clean out
- Non-skid, adjustable glides on legs

OPTIONAL G55 POWER/USB MODULE

- Single-sided, pneumatic pop-out design: platinum metallic
- 6' cord
- 4" x 5" cut-out

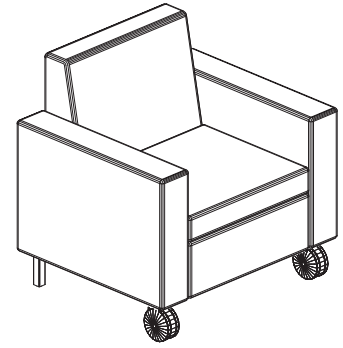

SURFACE MATERIALS

See the Kimball Hospitality Surface Materials Reference Guide at kimballhospitality.com for a complete overview of our materials program, including:

- Characteristics of wood
- Special wood finishes
- Customer specified laminate (CSL)
- Customer specified paint (CSP)
- Fabric application and colorways
- Customer's own material (COM) process overview
- Alliance program

ALLIANCE FABRIC PROGRAM

Kimball Hospitality has analyzed each model to most accurately reflect the COM/COL yardage requirements shown on page 702.

The yardage requirement for each model is based on 54" wide fabric and cutting the fabric up the roll.

If repeat is larger than 18", contact Customer Service to confirm the correct amount of yardage required. When ordering 10 or more chairs in the same COM, yardage requirements may be reduced.

Contact Customer Service.

PRICE GRADES A-R

See Surface Materials at www.kimballhospitality.com for a wide variety of graded-in fabrics from Arc-Com, Carnegie, CF Stinson, Designtex, Maharam, Mayer, Momentum, and Ultrafabrics.

FABRIC SAMPLES

If you need samples for presentation(s), contact our alliance partners directly at:

Arc-Com	800.223.5466	arc-com.com
Carnegie	800.727.6770	carnegiefabrics.com
CF Stinson	800.841.6279	cfstinson.com
Designtex	800.221.1540	designtex.com
Maharam	800.645.3943	maharam.com
Mayer	800.428.4415	mayerfabrics.com
Momentum	800.366.6839	memosamples.com
Ultrafabrics	877.309.6648	ultrafabricsllc.com

ARM CAPS

3D LAMINATE

WOODGRAIN

CO	Canyon
DF	Driftwood
MH	Mocha
YO	Monterey
NW	Tuscan

SOLID SURFACE

STANDARD

7101	Bisque
405	Designer White

PREMIUM*

467	Carbon Concrete
468	Neutral Concrete
464	Peace Grey
469	Weathered Concrete

*\$490 Upcharge applies

EOS*

495	EOS ^{CU} Beige
496	EOS ^{CU} Grey

*\$1324 Upcharge applies

WOOD

BZ	Brazilwood	MH	Mocha
CO	Canyon	YO	Monterey
CI	Chai	PC	Porcini
CC	Cordoba	PB	Portobello
DF	Driftwood	792	Sable
KN	Kona	NW	Tuscan
MW	Midtown	WL	Willow

IMPORTANT: Wood finishes applied to solid hardwood are complementary to the same wood finish applied to wood veneer, but not an exact match. Contact Customer Service for more information.

TABLETS

HIGH PRESSURE LAMINATE (HPL)

WOODGRAIN

BZ	Brazilwood
CO	Canyon
CI	Chai
CC	Cordoba
DF	Driftwood
KN	Kona
MW	Midtown
MH	Mocha
YO	Monterey
PC	Porcini
PB	Portobello
792	Sable
NW	Tuscan
WL	Willow

SOLID COLOR

462	Cinder
440	Cloud
457	Dapple
405	Designer White
450	Fog
488	Frosty White
461	Graphite
425	Shadow
460	Storm
419	Wallaby

TABLET ARM LOCATION

L	Left as Seated
R	Right as Seated
NH	Non-Handed (\$42 upcharge)
LR	(Loveseats and Sofas) Left and Right as Seated (\$516 upcharge for laminate) (\$553 upcharge for wood)

VILLA HEALTH

CASTERS

42 Black, Hard Dual Wheel

HANDLE

100_PL Round, Platinum Metal

LEG OPTIONS

SQUARE AND ROUND METAL LEGS

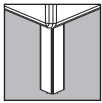

S

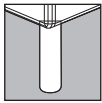

R

SOLID COLOR PAINT

462 Cinder
405 Designer White

METALLIC PAINT

501 Platinum Metallic

Y METAL LEG

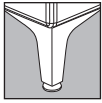

Y

SOLID COLOR PAINT

462 Cinder

METALLIC PAINT

501 Platinum Metallic

NON-PAINT

497 Polished Aluminum

TAPERED WOOD LEG

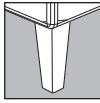

T

WOOD

BZ	Brazilwood	MH	Mocha
CO	Canyon	YO	Monterey
CI	Chai	PC	Porcini
CC	Cordoba	PB	Portobello
DF	Driftwood	792	Sable
KN	Kona	NW	Tuscan
MW	Midtown	WL	Willow

OPTIONAL G55 POWER/USB MODULE

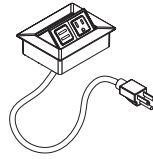

X No Power/USB Module
 G55KRPL Left Front as Seated (\$539 upcharge)
 G55KRPR Right Front as Seated (\$539 upcharge)
 G55KRPLR Left and Right Front (\$1078 upcharge)

TO ORDER, SPECIFY:

1. Model Number
2. Back Fabric Grade
3. Back Fabric Number
4. Seat/Base Fabric Grade
5. Seat/Base Fabric Number
6. Arm Fabric Grade
7. Arm Fabric Number
8. Wood Arm Cap Price Group (if applicable)
9. Arm Cap Finish Designator (if applicable)
10. Power/USB Module
11. Casters
12. Handle
13. Leg Option

- See pages 691-692 for Villa Health options
- See page 702 for COM fabric yardage

MOBILE LOUNGE CHAIR

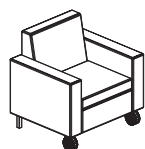

No Arm Caps

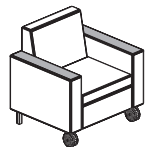

Arm Caps

MODEL NO.

ALLIANCE PROGRAM PRICE GRADES

			A	B	C	D	E	F	G	H	I
			J	K	L	M	N	O	P	Q	R
K6015ACOM	No Arm Caps	\$	3528	3735	3895	4059	4236	4443	4561	4785	4974
			5169	5482	6101	6496	6585	6662	6756	6850	7287
K6015ACOACWM	Wood Arm Caps		4063	4270	4430	4594	4771	4978	5096	5320	5509
			5704	6017	6636	7031	7120	7197	7291	7385	7822
K6015ACOACTM	3D Laminate Arm Caps		4064	4271	4431	4595	4772	4979	5097	5321	5510
			5705	6018	6637	7032	7121	7198	7292	7386	7823
K6015ACOACSM	Solid Surface Arm Caps		4430	4637	4797	4961	5138	5345	5463	5687	5876
			6071	6384	7003	7398	7487	7564	7658	7752	8189

DIMENSIONS

Width	35	Seat Height	18¾	Arm Height		Weight	61
Depth	29	Seat Depth	21½	No Arm Caps	26%	Cubic Ft.	28.70
Height	35¼	Seat Width	24¾	Arm Caps	27%		

- Clean out
- 123mm dual wheel casters on front: black
- Non-skid, adjustable glides on back legs
- Rounded handle on back: platinum metallic finish

VILLA HEALTH

TO ORDER, SPECIFY:

1. Model Number
2. Back Fabric Grade
3. Back Fabric Number
4. Seat/Base Fabric Grade
5. Seat/Base Fabric Number
6. Arm Fabric Grade
7. Arm Fabric Number
8. Wood Arm Cap Price Group (if applicable)
9. Tablet Arm Finish Designator
10. Tablet Arm Location
11. Power/USB Module
12. Casters
13. Handle
14. Leg Option

- See pages 691-692 for Villa Health options
- See page 702 for COM fabric yardage

VILLA HEALTH

MOBILE LOUNGE CHAIR WITH TABLET ARM



Tablet Arm
Note: Illustration above shows power/USB grommet and non-handed tablet arm grommet options

MODEL NO.

ALLIANCE PROGRAM PRICE GRADES

			A	B	C	D	E	F	G	H	I
			J	K	L	M	N	O	P	Q	R
K6015ACOTLM	HPL Tablet Arm	\$	4046	4253	4413	4577	4754	4961	5079	5303	5492
			5687	6000	6619	7014	7103	7180	7274	7368	7805
K6015ACOTWM	Wood Tablet Arm		4086	4293	4453	4617	4794	5001	5119	5343	5532
			5727	6040	6659	7054	7143	7220	7314	7408	7845

DIMENSIONS

Width	35	Seat Height	18¾	Arm Height	26¾	Weight	69
Depth	29	Seat Depth	21¾			Cubic Ft.	28.70
Height	35¾	Seat Width	24¾				

- Clean out
- 123mm dual wheel casters on front: black
- Non-skid, adjustable glides on back legs
- Rounded handle on back: platinum metallic finish
- Tablet arm location may be specified as: L (left as seated); R (right as seated); or NH (non-handed for a \$42 upcharge)

TO ORDER, SPECIFY:

1. Model Number
2. Back Fabric Grade
3. Back Fabric Number
4. Seat/Base Fabric Grade
5. Seat/Base Fabric Number
6. Arm Fabric Grade
7. Arm Fabric Number
8. Wood Arm Cap Price Group (if applicable)
9. Arm Cap Finish Designator (if applicable)
10. Power/USB Module
11. Leg Option

- See pages 691-692 for Villa Health options
- See page 702 for COM fabric yardage

LOUNGE CHAIR

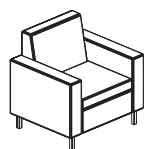

No Arm Caps

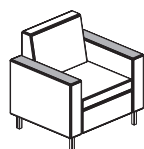

Arm Caps

MODEL NO.

ALLIANCE PROGRAM PRICE GRADES

		A	B	C	D	E	F	G	H	I
		J	K	L	M	N	O	P	Q	R
K6015ACO	No Arm Caps	\$ 3290	3497	3657	3821	3998	4205	4323	4547	4736
		4931	5244	5863	6258	6347	6424	6518	6612	7049
K6015ACOACW	Wood Arm Caps	3822	4029	4189	4353	4530	4737	4855	5079	5268
		5463	5776	6395	6790	6879	6956	7050	7144	7581
K6015ACOACT	3D Laminate Arm Caps	3822	4029	4189	4353	4530	4737	4855	5079	5268
		5463	5776	6395	6790	6879	6956	7050	7144	7581
K6015ACOACS	Solid Surface Arm Caps	4191	4398	4558	4722	4899	5106	5224	5448	5637
		5832	6145	6764	7159	7248	7325	7419	7513	7950

DIMENSIONS

Width	35	Seat Height	18¾	Arm Height		Weight	61
Depth	29	Seat Depth	21½	No Arm Caps	26%	Cubic Ft.	28.70
Height	35¼	Seat Width	24¾	Arm Caps	27%		

- Clean out
- Non-skid, adjustable glides on legs

VILLA HEALTH

TO ORDER, SPECIFY:

1. Model Number
2. Back Fabric Grade
3. Back Fabric Number
4. Seat/Base Fabric Grade
5. Seat/Base Fabric Number
6. Arm Fabric Grade
7. Arm Fabric Number
8. Wood or HPL Price Group
9. Tablet Arm Finish Designator
10. Tablet Arm Location
11. Power/USB Module
12. Leg Option

- See pages 691-692 for Villa Health options
- See page 702 for COM fabric yardage

LOUNGE CHAIR WITH TABLET ARM

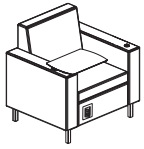

Tablet Arm
Note: Illustration above shows power/USB grommet (on the right as seated) and non-handed tablet arm grommet options

MODEL NO.

ALLIANCE PROGRAM PRICE GRADES

			A	B	C	D	E	F	G	H	I
			J	K	L	M	N	O	P	Q	R
K6015ACOTL	HPL Tablet Arm	\$	3806	4013	4173	4337	4514	4721	4839	5063	5252
			5447	5760	6379	6774	6863	6940	7034	7128	7565
K6015ACOTW	Wood Tablet Arm		3847	4054	4214	4378	4555	4762	4880	5104	5293
			5488	5801	6420	6815	6904	6981	7075	7169	7606

DIMENSIONS

Width	35	Seat Height	18¾	Arm Height	26¾	Weight	69
Depth	29	Seat Depth	21¾			Cubic Ft.	28.70
Height	35¾	Seat Width	24¾				

- Clean out
- Non-skid, adjustable glides on back legs
- Tablet arm location may be specified as: L (left as seated); R (right as seated); or NH (non-handed for a \$42 upcharge)

TO ORDER, SPECIFY:

1. Model Number
2. Back Fabric Grade
3. Back Fabric Number
4. Seat/Base Fabric Grade
5. Seat/Base Fabric Number
6. Arm Fabric Grade
7. Arm Fabric Number
8. Wood Arm Cap Price Group (if applicable)
9. Arm Cap Finish Designator (if applicable)
10. Power/USB Module
11. Leg Option

- See pages 691-692 for Villa Health options
- See page 702 for COM fabric yardage

LOVESEAT

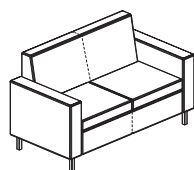

No Arm Caps

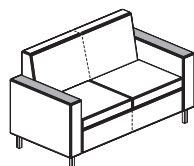

Arm Caps

MODEL NO.

ALLIANCE PROGRAM PRICE GRADES

		A	B	C	D	E	F	G	H	I
		J	K	L	M	N	O	P	Q	R
K6025ACO	No Arm Caps	\$ 4355	4615	4815	5021	5243	5503	5651	5932	6169
		6413	6804	7581	8078	8189	8284	8403	8522	9069
K6025ACOACW	Wood Arm Caps	4889	5149	5349	5555	5777	6037	6185	6466	6703
		6947	7338	8115	8612	8723	8818	8937	9056	9603
K6025ACOACT	3D Laminate Arm Caps	4891	5151	5351	5557	5779	6039	6187	6468	6705
		6949	7340	8117	8614	8725	8820	8939	9058	9605
K6025ACOACS	Solid Surface Arm Caps	5252	5512	5712	5918	6140	6400	6548	6829	7066
		7310	7701	8478	8975	9086	9181	9300	9419	9966

DIMENSIONS

Width	58¾	Seat Height	18¾	Arm Height		Weight	83.9
Depth	29	Seat Depth	21½	No Arm Caps	26%	Cubic Ft.	37.40
Height	35¼	Seat Width	48¾	Arm Caps	27%		

- Clean out
- Non-skid, adjustable glides on back legs

VILLA HEALTH

TO ORDER, SPECIFY:

1. Model Number
2. Back Fabric Grade
3. Back Fabric Number
4. Seat/Base Fabric Grade
5. Seat/Base Fabric Number
6. Arm Fabric Grade
7. Arm Fabric Number
8. Wood or HPL Price Group
9. Tablet Arm Finish Designator
10. Tablet Arm Location
11. Power/USB Module
12. Leg Option

- See pages 691-692 for Villa Health options
- See page 702 for COM fabric yardage

LOVESEAT WITH TABLET ARM

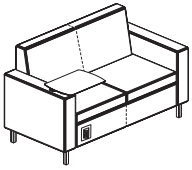

Tablet Arm
Note: Illustration above shows power/USB grommet option (on right as seated)

MODEL NO.

ALLIANCE PROGRAM PRICE GRADES

			A	B	C	D	E	F	G	H	I
			J	K	L	M	N	O	P	Q	R
K6025ACOTL	HPL Tablet Arm	\$	4875	5135	5335	5541	5763	6023	6171	6452	6689
			6933	7324	8101	8598	8709	8804	8923	9042	9589
K6025ACOTW	Wood Tablet Arm		4914	5174	5374	5580	5802	6062	6210	6491	6728
			6972	7363	8140	8637	8748	8843	8962	9081	9628

DIMENSIONS

Width	58¾	Seat Height	18¾	Arm Height	26¾	Weight	91.9
Depth	29	Seat Depth	21¾			Cubic Ft.	37.40
Height	35¾	Seat Width	48¾				

- Clean out
- Non-skid, adjustable glides on back legs
- Tablet arm location may be specified as: L (left as seated); R (right as seated); NH (non-handed for a \$42 upcharge) or LR (left and right as seated). A \$516 upcharge applies for laminate tablet and a \$553 upcharge applies for a wood tablet

TO ORDER, SPECIFY:

1. Model Number
2. Back Fabric Grade
3. Back Fabric Number
4. Seat/Base Fabric Grade
5. Seat/Base Fabric Number
6. Arm Fabric Grade
7. Arm Fabric Number
8. Wood Arm Cap Price Group (if applicable)
9. Arm Cap Finish Designator (if applicable)
10. Power/USB Module
11. Leg Option

- See pages 691-692 for Villa Health options
- See page 702 for COM fabric yardage

SOFA

MODEL NO.

ALLIANCE PROGRAM PRICE GRADES

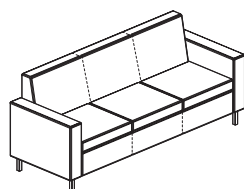

No Arm Caps

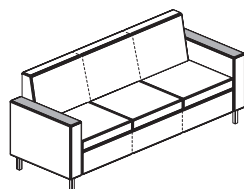

Arm Caps

			A	B	C	D	E	F	G	H	I
			J	K	L	M	N	O	P	Q	R
K6035ACO	No Arm Caps	\$	5421	5732	5974	6222	6489	6800	6978	7316	7601
			7895	8367	9301	9897	10031	10147	10289	10431	11090
K6035ACOACW	Wood Arm Caps		5955	6266	6508	6756	7023	7334	7512	7850	8135
			8429	8901	9835	10431	10565	10681	10823	10965	11624
K6035ACOACT	3D Laminate Arm Caps		5955	6266	6508	6756	7023	7334	7512	7850	8135
			8429	8901	9835	10431	10565	10681	10823	10965	11624
K6035ACOACS	Solid Surface Arm Caps		6319	6630	6872	7120	7387	7698	7876	8214	8499
			8793	9265	10199	10795	10929	11045	11187	11329	11988

DIMENSIONS

Width	82¾	Seat Height	18¾	Arm Height		Weight	114.8
Depth	29	Seat Depth	21½	No Arm Caps	26%	Cubic Ft.	64.60
Height	35¼	Seat Width	72¼	Arm Caps	27%		

- Clean out
- Non-skid, adjustable glides on back legs

VILLA HEALTH

TO ORDER, SPECIFY:

1. Model Number
2. Back Fabric Grade
3. Back Fabric Number
4. Seat/Base Fabric Grade
5. Seat/Base Fabric Number
6. Arm Fabric Grade
7. Arm Fabric Number
8. Wood or HPL Price Group
9. Tablet Arm Finish Designator
10. Tablet Arm Location
11. Power/USB Module
12. Leg Option

- See pages 691-692 for Villa Health options
- See page 702 for COM fabric yardage

SOFA WITH TABLET ARM

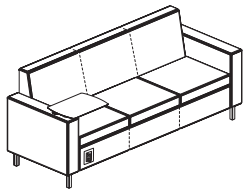

Tablet Arm
 Note: Illustration at left shows power/USB grommet option (on right as seated)

MODEL NO.

ALLIANCE PROGRAM PRICE GRADES

			A	B	C	D	E	F	G	H	I
			J	K	L	M	N	O	P	Q	R
K6035ACOTL	HPL Tablet Arm	\$	5938	6249	6491	6739	7006	7317	7495	7833	8118
			8412	8884	9818	10414	10548	10664	10806	10948	11607
K6035ACOTW	Wood Tablet Arm		5977	6288	6530	6778	7045	7356	7534	7872	8157
			8451	8923	9857	10453	10587	10703	10845	10987	11646

DIMENSIONS

Width	82¼	Seat Height	18¾	Arm Height	26¾	Weight	122.8
Depth	29	Seat Depth	21¾			Cubic Ft.	64.60
Height	35½	Seat Width	72¼				

- Clean out
- Non-skid, adjustable glides on back legs
- Tablet arm location may be specified as: L (left as seated); R (right as seated); NH (non-handed for a \$42 upcharge) or LR (left and right as seated). A \$516 upcharge applies for laminate tablet and a \$553 upcharge applies for a wood tablet

TO ORDER, SPECIFY:

1. Model Number
2. Back Fabric Grade
3. Back Fabric Number
4. Seat/Base Fabric Grade
5. Seat/Base Fabric Number
6. Seat Cushion Firmness
7. Power/USB Module
8. Leg Option

- See pages 691-692 for Villa Health options
- See page 702 for COM fabric yardage

45° CRESCENT LOUNGE

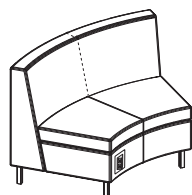

Note: Illustration above shows power/USB grommet option (on right as seated)

MODEL NO.

ALLIANCE PROGRAM PRICE GRADES

			A	B	C	D	E	F	G	H	I
			J	K	L	M	N	O	P	Q	R
K60CCCO	Crescent Lounge	\$	4336	4515	4653	4795	4948	5127	5229	5422	5586
			5754	6025	6560	6901	6978	7045	7126	7207	7585

DIMENSIONS

Width	53	Seat Height	18¾	Weight	112.5
Depth	32	Seat Depth	21¾	Cubic Ft.	51.30
Height	35¼	Seat Width	53		

- Clean out
- Non-skid, adjustable glides on back legs
- Seat cushion firmness - specify STD Standard cushion

COM YARDAGE REQUIREMENTS

COM YARDAGE REQUIREMENTS (54" WIDTH – CUT UP THE ROLL)

MODEL	RAILROADED Contact customer service 800-634-9510 for ydg requirements	NON DIRECTIONAL OR SOLID	1"-4" REPEAT	5"-11" REPEAT	12"-18" REPEAT	COL SQUARE FEET
			4" VERTICAL X 4" HORIZONTAL	11" VERTICAL X 11" HORIZONTAL	18" VERTICAL X 18" HORIZONTAL	
K6015ACOM, K6015ACOACWM, K6015ACOACTM, K6015ACOACSM	Entire Unit	4.70	6.00	7.80	8.80	91
	Back	1.80	1.90	2.10	3.10	33.3
	Base/Seat	1.40	1.50	2.70	3.70	25
	Arms	2.70	2.80	3.80	4.00	51.5
K6015ACOTLM, K6015ACOTWM	Entire Unit	4.70	6.00	7.80	8.80	91
	Back	1.80	1.90	2.10	3.10	33.3
	Base/Seat	1.40	1.50	2.70	3.70	25
	Arms	2.70	2.80	3.80	4.00	51.5
K6015ACO, K6015ACOACW, K6015ACOACT, K6015ACOACS	Entire Unit	4.70	6.00	7.80	8.80	91
	Back	1.80	1.90	2.10	3.10	33.3
	Base/Seat	1.40	1.50	2.70	3.70	25
	Arms	2.70	2.80	3.80	4.00	51.5
K6015ACOTL, K6015ACOTW	Entire Unit	4.70	6.00	7.80	8.80	91
	Back	1.80	1.90	2.10	3.10	33.3
	Base/Seat	1.40	1.50	2.70	3.70	25
	Arms	2.70	2.80	3.80	4.00	51.5
K6025ACO, K6025ACOACW, K6025ACOACT, K6025ACOACS	Entire Unit	5.90	9.10	11.80	12.30	117
	Back	2.60	4.70	5.50	5.50	62.5
	Base/Seat	2.10	3.00	4.50	6.20	40
	Arms	2.70	2.80	3.80	4.00	51.5
K6025ACOTL, K6025ACOTW	Entire Unit	5.90	9.10	11.80	12.30	117
	Back	2.60	4.70	5.50	5.50	62.5
	Base/Seat	2.10	3.00	4.50	6.20	40
	Arms	2.70	2.80	3.80	4.00	51.5
K6035ACO, K6035ACOACW, K6035ACOACT, K6035ACOACS	Entire Unit	7.70	12.30	15.20	17.20	151
	Back	3.30	5.20	5.80	7.10	63
	Base/Seat	2.90	4.30	6.30	8.70	57
	Arms	2.70	2.80	3.80	4.00	51.5
K6035ACOTL, K6035ACOTW	Entire Unit	7.70	12.30	15.20	17.20	151
	Back	3.30	5.20	5.80	7.10	63
	Base/Seat	2.90	4.30	6.30	8.70	57
	Arms	2.70	2.80	3.80	4.00	51.5
K60CCCO	Entire Unit	4.30	5.30	6.90	8.70	83.5
	Back	3.40	3.50	3.90	4.50	66.5
	Base/Seat	2.90	4.30	6.30	8.70	57