Fringe

LOUNGE

Product Specifications	198
Fabrics and Options	199
Contrasting Fabrics Specifications	201
Product Pages	203

BISTRO

Product Specifications	228
Fabrics and Options	229
Contrasting Fabrics Specifications	231
Product Pages	232

TABLES

Product Specifications	249
Fabrics and Options	250
Product Pages	251

TYPICALS

262

COM YARDAGE REQUIREMENTS

264

FRINGE LOUNGE PRODUCT SPECIFICATIONS

FRAME CONSTRUCTION

- Interior frame is constructed of oriented strand board with tenon joints that are glued and screwed for maximum joint stability
- Each joint is securely glued for maximum stability

SEAT CONSTRUCTION

- Lounge chairs feature 5½" of high grade polyurethane foam covering an oriented strand board seat panel
- Club chair features 7½" of high grade polyurethane foam covering an oriented strand board seat panel

BACK CONSTRUCTION

- Lounge chairs feature 1½" of high grade custom shaped polyurethane foam stretched over web sheet and attached to frame
- Club chair features 2¼" of high grade custom shaped polyurethane foam stretched over web sheet and attached to frame

ARM REST

- Lounge chairs feature oriented strand board constructed arm frame covered with ¾" high grade polyurethane foam on arm surface and ¾" on the sides
- Club chair features oriented strand board constructed arm frame covered with 2" high grade polyurethane foam on arm surface and ¾" on the sides

TABLET ARMS

- ¾" thick laminate with MDF core or ¾" thick plywood with veneer surface
- Attached with ¼" steel base plate with screws that mounts over a ¾" insert rod and fits into structure of arm
- Allows for 360° swivel and writing surface of 17" W x 12" D
- Tablet height is 28½" from floor to top of tablet surface

LEGS AND GLIDES

- Die-cast aluminum legs available in polished or powder coated Concrete, Cinder, Iron, Platinum Metallic, or Satin Nickel Metallic
- Wood legs finished with catalyzed top coat which resists denting, peeling and reactions to chemicals
- Can be cleaned with a damp cloth
- When specifying Brighton, Natural, and Sonoma finish, variation in color is acceptable due to the nature of wood characteristics
- Features a black 1" adjustable leveling glide
- Soft glides are available for an additional upcharge
- Black LPL plinth base; available on booth models only

CLUB CHAIR BASE AND GLIDES

- Die-cast aluminum 5-prong base available in polished or powder coated Cinder, Platinum Metallic, or Satin Nickel Metallic
- Non-marring nylon glides

CLUB CHAIR CONTROL

- Features 360° swivel with auto-return, static model only

UPHOLSTERY DETAIL

- Contrasting fabric available on all models, except benches and armless club chair

POWER GROMMET

- Features 2 electrical receptacles and 2 power USB ports
- Die-cast zinc in black or silver powder coat
- 9 foot, 15 Amp cord
- UL Listed

UPHOLSTERED DIVIDER PANELS

- Constructed with an oriented strand board frame covered with ¾" high grade polyurethane foam on top and ¾" on the sides
- Upholstered divider panels are able to be attached on either side of a lounge, or in between ganged lounge units within a configuration
- If attaching to an armed unit, arm must be removed before mounting divider panel
- Compatible on N93 models
- Compatible with one, two and three seat lounge, with the exception of bistro and booth models

LAMINATE AND VENEER DIVIDER AND BACK PRIVACY PANELS

- ¾" edge banded HPL or Veneer
- Veneer features a semi-open pore matte sheen
- Attached with silver visible fasteners
- Laminate and Veneer Divider panels are able to be attached on either side of a lounge, or in between lounge units within a configuration
- Divider panels can be attached to an armless unit, or attached to an arm of any height, with the exception of tablet arms
- Divider panels and back panels are compatible on both N92 and N93 one, two and three seat lounge models, and single-sided booths
- Divider panels are compatible with bistro models, corners, curves, wedges, and coves
- When retrofitting a back panel onto a bistro model, the bistro table must be removed for the life of the back panel

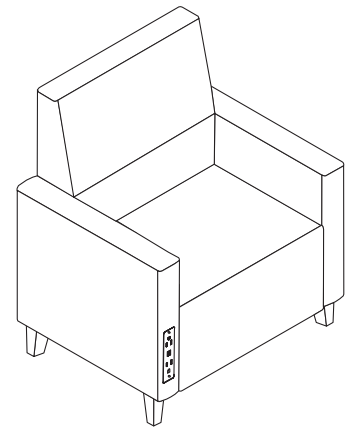
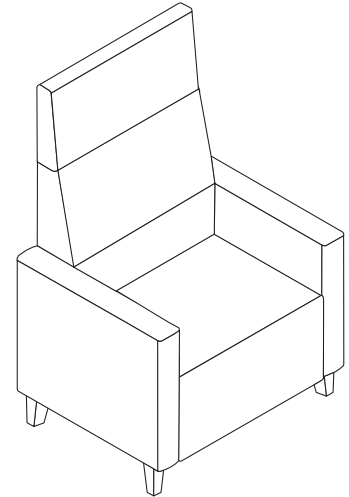

SURFACE MATERIALS

See the Kimball Hospitality Surface Materials Reference Guide at kimballhospitality.com for a complete overview of our materials program, including:

- Characteristics of wood
- Special wood finishes
- Customer-specified laminate (CSL)
- Customer-specified paint (CSP)
- Fabric application and colorways
- Customer's own material (COM) process overview
- Alliance program

ALLIANCE FABRIC PROGRAM

Kimball Hospitality has analyzed each model to most accurately reflect the COM/COL yardage requirements shown on page 264.

The yardage requirement for each model is based on 54" W fabric and cutting the fabric up the roll.

If repeat is larger than 18", contact Customer Service to confirm the correct amount of yardage required. When ordering 10 or more chairs in the same COM, yardage requirements may be reduced.

Contact Customer Service.

PRICE GRADES A-R

See Surface Materials at www.kimballhospitality.com for a wide variety of graded-in fabrics from Arc-Com, CF Stinson, Designtex, Maharam, Momentum, and Ultrafabrics.

FABRIC SAMPLES

If you need samples for presentation(s), contact our alliance partners directly at:

Arc-Com	800.223.5466	arc-com.com
Designtex	800.221.1540	designtex.com
CF Stinson	800.841.6279	cfstinson.com
Maharam	800.645.3943	maharam.com
Momentum	800.366.6839	memosamples.com
Ultrafabrics	877.309.6648	ultrafabricsllc.com

TABLET ARM

LAMINATE

LAC2	Laminate, Autumn 2
LAD	Laminate, Almond
LCL	Laminate, Caramel
LCW	Laminate, Cordovan
LDW	Laminate, Judicial
LHN2	Laminate, Honey 2
LIM	Laminate, Brighton
LMC	Laminate, Amber
LMH	Laminate, Mocha
LNМ	Laminate, Natural
LPB	Laminate, Portobello
LPT	Laminate, Portico
LSK	Laminate, Skyline
LSM	Laminate, Sonoma
LTF	Laminate, Truffle
L405	Laminate, Designer White
L419	Laminate, Wallaby
L425	Laminate, Shadow
L440	Laminate, Cloud
L461	Laminate, Graphite
L462	Laminate, Cinder
L478	Laminate, Platinum Grey
L488	Laminate, Frosty White
L491	Laminate, Designer White Linear
L492	Laminate, Cinder Linear
L792	Laminate, Sable
L793	Laminate, Acorn*

WOOD

WAC	Wood, Autumn
WAD	Wood, Almond
WCL	Wood, Caramel
WCW	Wood, Cordovan
WDW	Wood, Judicial
WHN	Wood, Honey
WIM	Wood, Brighton
WMC	Wood, Amber
WMH	Wood, Mocha
WNM	Wood, Natural
WPB	Wood, Portobello
WPT	Wood, Portico
WSK	Wood, Skyline
WSM	Wood, Sonoma
WTF	Wood, Truffle
W405	Wood, Designer White
W462	Wood, Cinder
W792	Wood, Sable
W793	Wood, Acorn*

*Acorn is the wood and laminate complement to Clear Walnut finish

GALLERY TABLET ARM

Grade 1 – 5% upcharge	
LG1001	Laminate, Citadel
LG1011	Laminate, Pepperdust
Grade 2 – 6% upcharge	
LG1002	Laminate, Planked Raw Oak
LG1003	Laminate, Evening Notte
LG1004	Laminate, Kirsche
LG1005	Laminate, Midnight Run
LG1006	Laminate, Sepia Walnut
LG1007	Laminate, Serotina
LG1008	Laminate, Timeless
LG1009	Laminate, White Nebbia
LG1012	Laminate, Phantom Ecru

See page 20 for Gallery program details and upcharges

LEG/BASE COLORS

METAL

423	Concrete
462	Cinder
463	Iron
497	Polished Aluminum
501	Platinum Metallic
503	Satin Nickel Metallic

GLIDES

STD	Standard
C10	Soft (add \$30 list)

WOOD (\$150 LIST UPCHARGE PER CHAIR)

WAC	Autumn	WPB	Portobello
WAD	Almond	WPT	Portico
WCL	Caramel	WSK	Skyline
WCW	Cordovan	WSM	Sonoma
WDW	Judicial	WTF	Truffle
WHN	Honey	W405	Designer White
WIM	Brighton	W462	Cinder
WMC	Amber	W792	Sable
WMH	Mocha	W793	Acorn*
WNM	Natural		

FRINGE

POWER GROMMET OPTIONS

(\$524 list upcharge per location)

- G23BL Black, Left
- G23BR Black, Right
- G23BLR Black, Left & Right
- G23SL Silver, Left
- G23SR Silver, Right
- G23SLR Silver, Left & Right
- X No Grommet

CORNER WITH POWER GROMMETS

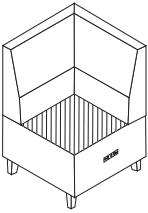

LOUNGE WITH POWER GROMMETS

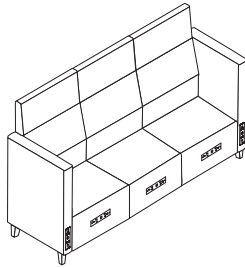

WEDGES WITH POWER GROMMETS

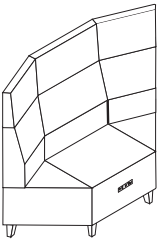

COVE WITH POWER GROMMETS

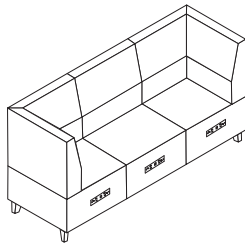

BENCH WITH POWER GROMMETS

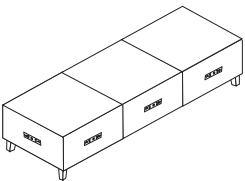

FRINGE, LOUNGE

- Mid Back 1 Seat Lounge page 203
- Mid Back 1 Seat Lounge with Clean Out page 203
- Mid Back 1 Seat Lounge Single Arm page 204
- Mid Back 1 Seat Lounge Single Arm with Clean Out page 204
- Mid Back 1 Seat Single Booth page 220
- Mid Back 2 Seat Lounge page 207
- Mid Back 2 Seat Lounge with Clean Out page 207
- Mid Back 2 Seat Lounge Single Arm page 208
- Mid Back 2 Seat Lounge Single Arm with Clean Out page 208
- Mid Back 2 Seat Double Booth page 222
- Mid Back 2 Seat Double Booth Clean Out page 222
- Mid Back 2 Seat Cove Lounge page 215
- Mid Back 3 Seat Lounge page 211
- Mid Back 3 Seat Lounge with Clean Out page 211
- Mid Back 3 Seat Lounge Single Arm page 212
- Mid Back 3 Seat Lounge Single Arm with Clean Out page 212
- Mid Back 3 Seat Cove Lounge page 215
- Mid Back Square 90° Corner page 216

1. Model Number plus "X"
2. Back Fabric Grade Number/Cover Number
3. Lumbar Fabric Grade Number/Cover Number
4. Extreme Back Grade Number/Cover Number
5. Seat Fabric Grade Number/Cover Number
6. Arm Fabric Grade Number/Cover Number (when applicable)
7. Front Arm Grommet
8. Front Seat Grommet
9. Tablet and Finish (when applicable)
10. Leg Color (when applicable)
11. Glides

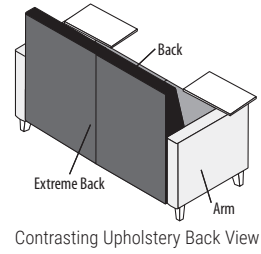
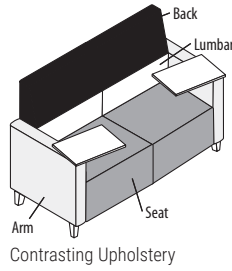

- High Back 1 Seat Lounge page 205
- High Back 1 Seat Lounge with Clean Out page 205
- High Back 1 Seat Lounge Single Arm page 206
- High Back 1 Seat Lounge Single Arm with Clean Out page 206
- High Back 1 Seat Single Booth page 220
- High Back 2 Seat Lounge page 209
- High Back 2 Seat Lounge with Clean Out page 209
- High Back 2 Seat Lounge Single Arm page 210
- High Back 2 Seat Lounge Single Arm with Clean Out page 210
- High Back 2 Seat Double Booth page 222
- High Back 2 Seat Double Booth Clean Out page 222
- High Back 2 Seat Cove Lounge page 215
- High Back 3 Seat Lounge page 213
- High Back 3 Seat Lounge with Clean Out page 213
- High Back 3 Seat Lounge Single Arm page 214
- High Back 3 Seat Lounge Single Arm with Clean Out page 214
- High Back 3 Seat Cove Lounge page 215
- High Back Square 90° Corner page 217

1. Model Number plus "X"
2. Back Fabric Grade Number/Cover Number
3. Lumbar Fabric Grade Number/Cover Number
4. Extreme Back Grade Number/Cover Number
5. Seat Fabric Grade Number/Cover Number
6. Arm Fabric Grade Number/Cover Number (when applicable)
7. Accent (headrest) Fabric Grade Number/Cover Number
8. Front Arm Grommet
9. Front Seat Grommet
10. Tablet and Finish (when applicable)
11. Leg Color (when applicable)
12. Glides

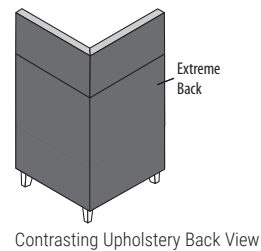
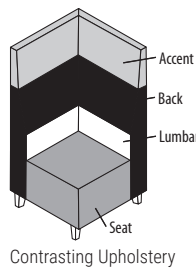
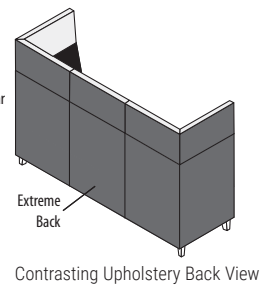
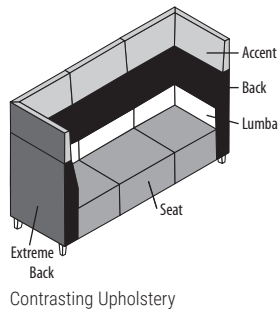
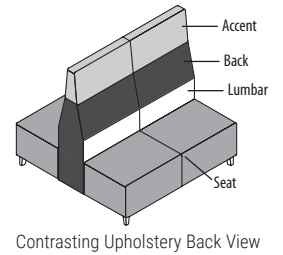
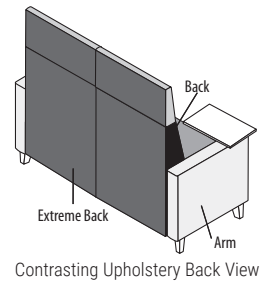
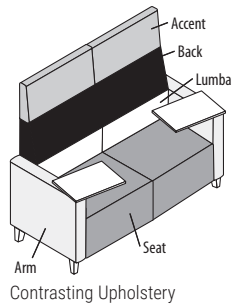

TO ORDER CONTRASTING FABRIC, SPECIFY

Mid Back Outside 90° Wedge page 218

Mid Back Outside 90° Round page 218

Mid Back Inside 90° Wedge page 218

Mid Back Inside 90° Round page 218

High Back Outside 90° Wedge page 219

High Back Outside 90° Round page 219

High Back Inside 90° Wedge page 219

High Back Inside 90° Round page 219

1. Model Number plus "X"
2. Back Fabric Grade Number/Cover Number
3. Lumbar Fabric Grade Number/Cover Number
4. Extreme Back Fabric Grade Number/Cover Number
5. Seat Fabric Grade Number/Cover Number
6. Accent (headrest) Fabric Grade Number/Cover Number (when applicable)
7. Front Seat Grommet
8. Leg Color
9. Glides

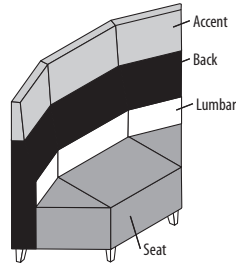

Contrasting Upholstery

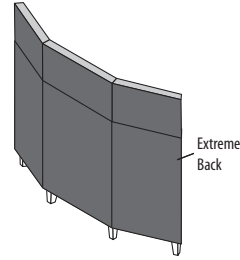

Contrasting Upholstery Back View

Club Chair page 225

1. Model Number plus "X"
2. Back Fabric Grade Number/Cover Number
3. Seat Fabric Grade Number/Cover Number
4. Arm Fabric Grade Number/Cover Number
5. Tablet Finish (when applicable)
6. Base Color

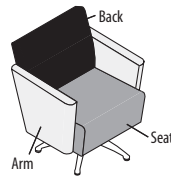

Contrasting Upholstery

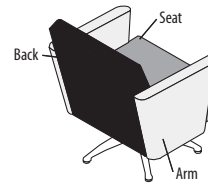

Contrasting Upholstery Back View

FABRIC APPLICATION DIAGRAMS (VERTICAL STRIPE DEPICTED)

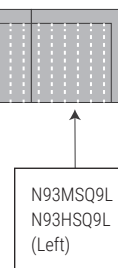
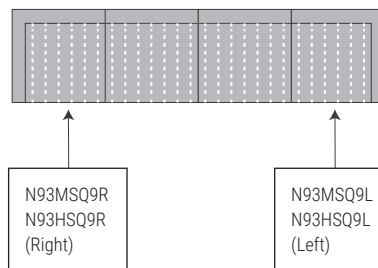
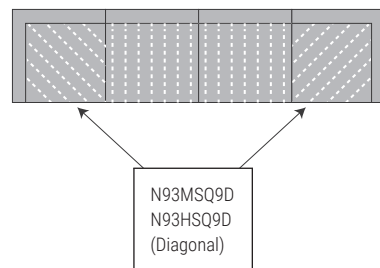
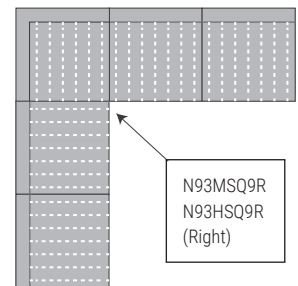
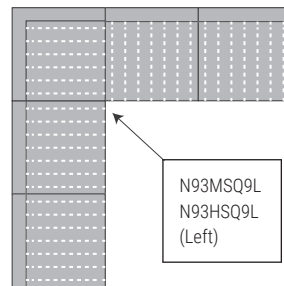
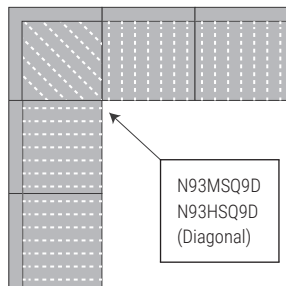

TO ORDER, SPECIFY:

1. Model Number
2. Fabric Grade / Cover Number
3. Front Arm Grommet
4. Front Seat Grommet
5. Tablet and Finish (when applicable)
6. Leg Color
7. Glides

- See pages 199-200 for Fringe options
- See pages 264-278 for COM fabric yardage

**MID BACK
1 SEAT LOUNGE**

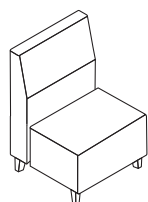

Armless with Clean Out

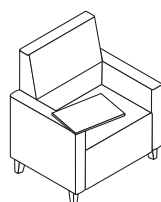

Tablet Right Arm

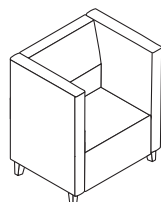

Mid Arms

**MODEL
NO.**

ALLIANCE PROGRAM PRICE GRADES

		A	B	C	D	E	F	G	H	I
		J	K	L	M	N	O	P	Q	R
N93M1M	Armless	\$ 1790	1873	1938	2010	2087	2171	2236	2320	2406
		2487	2620	2887	3051	3138	3228	3312	3398	3479
N93M1B	Arms	2422	2581	2705	2840	2988	3147	3271	3430	3596
		3749	4003	4510	4823	4988	5159	5318	5484	5637
N93M1BR	Tablet Right Arm	2674	2833	2957	3092	3240	3399	3523	3682	3848
		4001	4255	4762	5075	5240	5411	5570	5736	5889
N93M1BL	Tablet Left Arm	2674	2833	2957	3092	3240	3399	3523	3682	3848
		4001	4255	4762	5075	5240	5411	5570	5736	5889
N93M1BM	Mid Arms	2815	3015	3170	3340	3525	3725	3881	4080	4288
		4480	4798	5435	5827	6034	6249	6448	6656	6848
N93M10M	Armless with Clean Out	1825	1908	1973	2045	2122	2206	2271	2355	2441
		2522	2655	2922	3086	3173	3263	3347	3433	3514
N93M10B	Arms with Clean Out	2467	2626	2750	2885	3033	3192	3316	3475	3641
		3794	4048	4555	4868	5033	5204	5363	5529	5682
N93M10BM	Mid Arms with Clean Out	2869	3069	3224	3394	3579	3779	3935	4134	4342
		4534	4852	5489	5881	6088	6303	6502	6710	6902

DIMENSIONS

Width	24	Seat Height	18½	Arm Height	27½	Weight	69
Width with Arms	32	Seat Depth	20½	Mid Arm Height	40¼	Weight with Arms	107
Depth	27	Seat Width	24	Back Height	22½	Weight with Tablet	114
Height	40¼			Back Width	24	Weight with Mid Arms	123
						Cubic Ft.	21.4
						Cubic Ft. with Arms	26.9
						Cubic Ft. with Tablet	30.4

- Power grommet available on front of arm or seat (factory installed); specify grommet option
- Contrasting fabric option – specify X (i.e., N93M1MX); see page 201. For list pricing, use your electronic specification tool or contact customer service
- Accepts upholstered, laminate or veneer divider panels (page 226)
- Upholstered divider panels cannot be added to an existing arm
- Laminate and veneer divider panels can be added to an armless unit, onto the arm of a unit, or replace an existing arm
- Laminate and veneer divider panels cannot be added onto a tablet arm due to interference
- Accepts laminate and veneer back panels (page 227) which will be the height and width of a high back armless model

FRINGE

TO ORDER, SPECIFY:

1. Model Number
2. Fabric Grade / Cover Number
3. Front Arm Grommet
4. Front Seat Grommet
5. Tablet and Finish (when applicable)
6. Leg Color
7. Glides

- See pages 199-200 for Fringe options
- See pages 264-278 for COM fabric yardage

MID BACK 1 SEAT LOUNGE SINGLE ARM

MODEL NO.

ALLIANCE PROGRAM PRICE GRADES

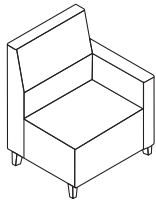

Left Arm

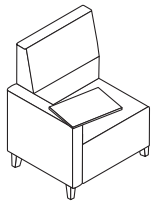

Tablet Right Arm

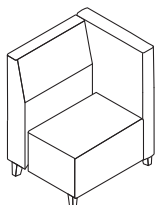

Left Mid Arm with Clean Out

			A	B	C	D	E	F	G	H	I
			J	K	L	M	N	O	P	Q	R
N93M1R	Right Arm	\$	2114	2240	2339	2447	2565	2692	2790	2917	3049
			3171	3373	3777	4026	4158	4294	4421	4553	4675
N93M1RR	Tablet Right Arm		2368	2494	2593	2701	2819	2946	3044	3171	3303
			3425	3627	4031	4280	4412	4548	4675	4807	4929
N93M1RM	Right Mid Arms		2309	2455	2568	2692	2827	2973	3087	3232	3384
			3524	3756	4221	4507	4658	4815	4960	5112	5252
N93M1L	Left Arm		2114	2240	2339	2447	2565	2692	2790	2917	3049
			3171	3373	3777	4026	4158	4294	4421	4553	4675
N93M1LL	Tablet Left Arm		2368	2494	2593	2701	2819	2946	3044	3171	3303
			3425	3627	4031	4280	4412	4548	4675	4807	4929
N93M1LM	Left Mid Arms		2309	2455	2568	2692	2827	2973	3087	3232	3384
			3524	3756	4221	4507	4658	4815	4960	5112	5252
N93M1OR	Right Arm with Clean Out		2155	2281	2380	2488	2606	2733	2831	2958	3090
			3212	3414	3818	4067	4199	4335	4462	4594	4716
N93M1ORM	Right Mid Arms with Clean Out		2354	2500	2613	2737	2872	3018	3132	3277	3429
			3569	3801	4266	4552	4703	4860	5005	5157	5297
N93M1OL	Left Arm with Clean Out		2155	2281	2380	2488	2606	2733	2831	2958	3090
			3212	3414	3818	4067	4199	4335	4462	4594	4716
N93M1OLM	Left Mid Arms with Clean Out		2354	2500	2613	2737	2872	3018	3132	3277	3429
			3569	3801	4266	4552	4703	4860	5005	5157	5297

DIMENSIONS

Width	28	Seat Height	18½	Arm Height	27½	Weight	88
Depth	27	Seat Depth	20½	Mid Arm Height	40¼	Weight with Tablet	95
Height	40¼	Seat Width	24	Back Height	22½	Weight with Mid Arms	96
				Back Width	24	Cubic Ft.	24.1
						Cubic Ft. with Tablet	27.4

- Power grommet available on front of arm or seat (factory installed); specify grommet option
- Contrasting fabric option – specify X (i.e., N93M1RX); see page 201. For list pricing, use your electronic specification tool or contact customer service
- Accepts upholstered, laminate or veneer divider panels (page 226)
- Upholstered divider panels cannot be added to an existing arm
- Laminate and veneer divider panels can be added to an armless unit, onto the arm of a unit, or replace an existing arm
- Laminate and veneer divider panels cannot be added onto a tablet arm due to interference
- Accepts laminate and veneer back panels (page 227) which will be the height and width of a high back armless model

TO ORDER, SPECIFY:

1. Model Number
2. Fabric Grade / Cover Number
3. Front Arm Grommet
4. Front Seat Grommet
5. Tablet and Finish (when applicable)
6. Leg Color
7. Glides

- See pages 199-200 for Fringe options
- See pages 264-278 for COM fabric yardage

**HIGH BACK
1 SEAT LOUNGE**

**MODEL
NO.**

ALLIANCE PROGRAM PRICE GRADES

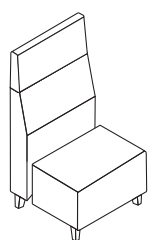

Armless with Clean Out

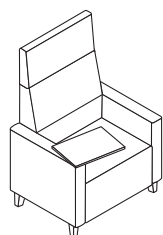

Tablet Right Arm

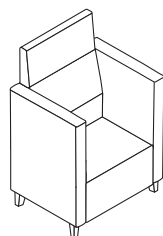

Mid Arms

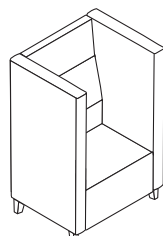

High Arms

		A	B	C	D	E	F	G	H	I
		J	K	L	M	N	O	P	Q	R
N93H1M	Armless	\$ 2361	2450	2519	2595	2677	2766	2836	2925	3017
		3103	3245	3529	3704	3796	3892	3981	4073	4159
N93H1B	Arms	2994	3158	3286	3427	3579	3744	3872	4037	4207
		4366	4628	5153	5476	5647	5824	5989	6159	6318
N93H1BR	Tablet Right Arm	3245	3409	3537	3678	3830	3995	4123	4288	4458
		4617	4879	5404	5727	5898	6075	6240	6410	6569
N93H1BL	Tablet Left Arm	3245	3409	3537	3678	3830	3995	4123	4288	4458
		4617	4879	5404	5727	5898	6075	6240	6410	6569
N93H1BM	Mid Arms	3392	3599	3761	3938	4131	4339	4500	4708	4924
		5124	5455	6117	6525	6741	6964	7172	7388	7588
N93H1BH	High Arms	3509	3754	3945	4155	4382	4628	4819	5065	5319
		5556	5947	6730	7212	7467	7731	7977	8231	8468
N93H10M	Armless with Clean Out	2408	2497	2566	2642	2724	2813	2883	2972	3064
		3150	3292	3576	3751	3843	3939	4028	4120	4206
N93H10B	Arms with Clean Out	3051	3215	3343	3484	3636	3801	3929	4094	4264
		4423	4685	5210	5533	5704	5881	6046	6216	6375
N93H10BM	Mid Arms with Clean Out	3456	3663	3825	4002	4195	4403	4564	4772	4988
		5188	5519	6181	6589	6805	7028	7236	7452	7652
N93H10BH	High Arms with Clean Out	3575	3820	4011	4221	4448	4694	4885	5131	5385
		5622	6013	6796	7278	7533	7797	8043	8297	8534

DIMENSIONS

Width	24	Seat Height	18½	Arm Height	27½	Weight	83
Width with Arms	32	Seat Depth	20½	Mid Arm Height	40¼	Weight with Arms	121
Depth	27	Seat Width	24	High Arm Height	53¼	Weight with Tablet	128
Height	53¼			Back Height	35¼	Weight with Mid Arms	137
				Back Width	24	Weight with High Arms	153
						Cubic Ft.	27.2
						Cubic Ft. with Arms	34.3
						Cubic Ft. with Tablet	38.7

- Power grommet available on front of arm or seat (factory installed); specify grommet option
- Contrasting fabric option – specify X (i.e., N93H1MX); see page 201. For list pricing, use your electronic specification tool or contact customer service
- Accepts upholstered, laminate or veneer divider panels (page 226)
- Upholstered divider panels cannot be added to an existing arm
- Laminate and veneer divider panels can be added to an armless unit, onto the arm of a unit, or replace an existing arm
- Laminate and veneer divider panels cannot be added onto a tablet arm due to interference
- Accepts laminate and veneer back panels (page 227) which will be the height and width of a high back armless model

FRINGE

TO ORDER, SPECIFY:

1. Model Number
2. Fabric Grade / Cover Number
3. Front Arm Grommet
4. Front Seat Grommet
5. Tablet and Finish (when applicable)
6. Leg Color
7. Glides

- See pages 199-200 for Fringe options
- See pages 264-278 for COM fabric yardage

HIGH BACK 1 SEAT LOUNGE SINGLE ARM

MODEL NO.

ALLIANCE PROGRAM PRICE GRADES

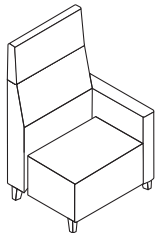

Left Arm with Clean Out

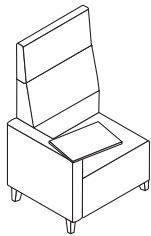

Tablet Right Arm

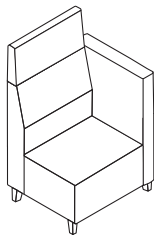

Left Mid Arm

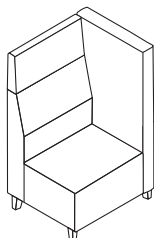

Left High Arm

			A	B	C	D	E	F	G	H	I
			J	K	L	M	N	O	P	Q	R
N93H1R	Right Arm	\$	2686	2818	2921	3033	3156	3288	3391	3523	3661
			3788	3999	4420	4680	4817	4959	5091	5229	5356
N93H1RR	Tablet Right Arm		2940	3072	3175	3287	3410	3542	3645	3777	3915
			4042	4253	4674	4934	5071	5213	5345	5483	5610
N93H1RM	Right Mid Arms		2879	3030	3148	3277	3417	3568	3685	3837	3993
			4139	4380	4861	5158	5315	5477	5629	5785	5931
N93H1RH	Right High Arms		2939	3109	3241	3386	3543	3713	3846	4016	4192
			4356	4627	5169	5503	5679	5862	6032	6208	6372
N93H1L	Left Arm		2686	2818	2921	3033	3156	3288	3391	3523	3661
			3788	3999	4420	4680	4817	4959	5091	5229	5356
N93H1LL	Tablet Left Arm		2940	3072	3175	3287	3410	3542	3645	3777	3915
			4042	4253	4674	4934	5071	5213	5345	5483	5610
N93H1LM	Left Mid Arms		2879	3030	3148	3277	3417	3568	3685	3837	3993
			4139	4380	4861	5158	5315	5477	5629	5785	5931
N93H1LH	Left High Arms		2939	3109	3241	3386	3543	3713	3846	4016	4192
			4356	4627	5169	5503	5679	5862	6032	6208	6372
N93H1OR	Right Arm with Clean Out		2738	2870	2973	3085	3208	3340	3443	3575	3713
			3840	4051	4472	4732	4869	5011	5143	5281	5408
N93H1ORM	Right Mid Arms with Clean Out		2934	3085	3203	3332	3472	3623	3740	3892	4048
			4194	4435	4916	5213	5370	5532	5684	5840	5986
N93H1ORH	Right High Arms with Clean Out		2994	3164	3296	3441	3598	3768	3901	4071	4247
			4411	4682	5224	5558	5734	5917	6087	6263	6427
N93H1OL	Left Arm with Clean Out		2738	2870	2973	3085	3208	3340	3443	3575	3713
			3840	4051	4472	4732	4869	5011	5143	5281	5408
N93H1OLM	Left Mid Arms with Clean Out		2934	3085	3203	3332	3472	3623	3740	3892	4048
			4194	4435	4916	5213	5370	5532	5684	5840	5986
N93H1OLH	Left High Arms with Clean Out		2994	3164	3296	3441	3598	3768	3901	4071	4247
			4411	4682	5224	5558	5734	5917	6087	6263	6427

DIMENSIONS

Width	28	Seat Height	18½	Arm Height	27½	Weight	102
Depth	27	Seat Depth	20½	Mid Arm Height	40¼	Weight with Tablet	109
Height	53¼	Seat Width	24	High Arm Height	53¼	Weight with Mid Arms	110
				Back Height	35¼	Weight with High Arms	118
				Back Width	24	Cubic Ft.	30.8
						Cubic Ft. with Tablet	35.0

- Power grommet available on front of arm or seat (factory installed); specify grommet option
- Contrasting fabric option – specify X (i.e., N93H1RX); see page 201. For list pricing, use your electronic specification tool or contact customer service
- Accepts upholstered, laminate or veneer divider panels (page 226)
- Upholstered divider panels cannot be added to an existing arm
- Laminate and veneer divider panels can be added to an armless unit, onto the arm of a unit, or replace an existing arm
- Laminate and veneer divider panels cannot be added onto a tablet arm due to interference
- Accepts laminate and veneer back panels (page 227) which will be the height and width of a high back armless model

TO ORDER, SPECIFY:

1. Model Number
2. Fabric Grade / Cover Number
3. Front Arm Grommet
4. Front Seat Grommet
5. Tablet and Finish (when applicable)
6. Leg Color
7. Glides

- See pages 199-200 for Fringe options
- See pages 264-278 for COM fabric yardage

**MID BACK
2 SEAT LOUNGE**

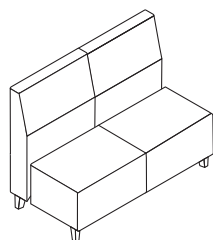

Armless with Clean Out

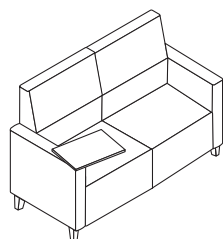

Tablet Right Arm

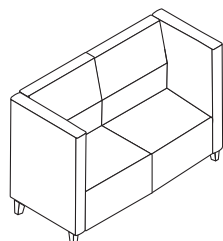

Mid Arms

**MODEL
NO.**

ALLIANCE PROGRAM PRICE GRADES

		A	B	C	D	E	F	G	H	I
		J	K	L	M	N	O	P	Q	R
N93M2M	Armless	\$ 2606	2725	2817	2918	3028	3147	3240	3358	3482
		3596	3785	4164	4397	4520	4648	4766	4890	5004
N93M2B	Arms	3238	3432	3584	3749	3929	4124	4275	4469	4671
		4858	5168	5787	6168	6370	6579	6773	6975	7162
N93M2BR	Tablet Right Arm	3491	3685	3837	4002	4182	4377	4528	4722	4924
		5111	5421	6040	6421	6623	6832	7026	7228	7415
N93M2BL	Tablet Left Arm	3491	3685	3837	4002	4182	4377	4528	4722	4924
		5111	5421	6040	6421	6623	6832	7026	7228	7415
N93M2BB	Tablet Both Arms	3742	3936	4088	4253	4433	4628	4779	4973	5175
		5362	5672	6291	6672	6874	7083	7277	7479	7666
N93M2BM	Mid Arms	3637	3875	4059	4262	4482	4719	4904	5142	5388
		5617	5995	6752	7219	7465	7720	7958	8204	8433
N93M2OM	Armless with Clean Out	2671	2797	2896	3004	3122	3249	3347	3474	3606
		3728	3930	4334	4583	4715	4851	4978	5110	5232
N93M2OB	Arms with Clean Out	3317	3522	3682	3857	4047	4252	4411	4617	4829
		5027	5354	6007	6410	6623	6843	7049	7261	7459
N93M2OBM	Mid Arms with Clean Out	3713	3956	4145	4352	4577	4820	5009	5252	5504
		5738	6125	6899	7376	7628	7889	8132	8384	8618

DIMENSIONS

Width	47½	Seat Height	18½	Arm Height	27½	Weight	122
Width with Arms	55½	Seat Depth	20½	Mid Arm Height	40¼	Weight with Arms	160
Depth	27	Seat Width	47½	Back Height	22½	Weight with Tablet	168
Height	40¼			Back Width	47½	Weight with 2 Tablets	173
						Weight with Mid Arms	176
						Cubic Ft.	40.2
						Cubic Ft. with Arms	45.8
						Cubic Ft. with Tablet	50.5
						Cubic Ft. with 2 Tablets	52.2

- Power grommet available on front of arm or seat (factory installed); specify grommet option
- Contrasting fabric option – specify X (i.e., N93M2MX); see page 201. For list pricing, use your electronic specification tool or contact customer service
- Accepts upholstered, laminate or veneer divider panels (page 226)
- Upholstered divider panels cannot be added to an existing arm
- Laminate and veneer divider panels can be added to an armless unit, onto the arm of a unit, or replace an existing arm
- Laminate and veneer divider panels cannot be added onto a tablet arm due to interference
- Accepts laminate and veneer back panels (page 227) which will be the height and width of a high back armless model

FRINGE

TO ORDER, SPECIFY:

1. Model Number
2. Fabric Grade / Cover Number
3. Front Arm Grommet
4. Front Seat Grommet
5. Tablet and Finish (when applicable)
6. Leg Color
7. Glides

- See pages 199-200 for Fringe options
- See pages 264-278 for COM fabric yardage

MID BACK 2 SEAT LOUNGE SINGLE ARM

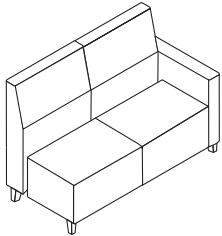

Left Arm with Clean Out

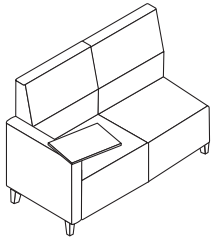

Tablet Right Arm

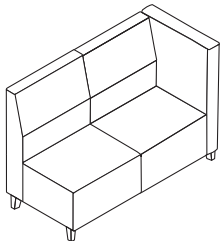

Left Mid Arm

MODEL NO.

ALLIANCE PROGRAM PRICE GRADES

			A	B	C	D	E	F	G	H	I
			J	K	L	M	N	O	P	Q	R
N93M2R	Right Arm	\$	2930	3092	3218	3356	3506	3668	3794	3956	4124
			4280	4538	5054	5372	5540	5714	5876	6044	6200
N93M2RR	Tablet Right Arm		3184	3346	3472	3610	3760	3922	4048	4210	4378
			4534	4792	5308	5626	5794	5968	6130	6298	6454
N93M2RM	Right Mid Arms		3127	3307	3448	3602	3770	3951	4091	4272	4460
			4634	4922	5498	5853	6041	6235	6416	6604	6778
N93M2L	Left Arm		2930	3092	3218	3356	3506	3668	3794	3956	4124
			4280	4538	5054	5372	5540	5714	5876	6044	6200
N93M2LL	Tablet Left Arm		3184	3346	3472	3610	3760	3922	4048	4210	4378
			4534	4792	5308	5626	5794	5968	6130	6298	6454
N93M2LM	Left Mid Arms		3127	3307	3448	3602	3770	3951	4091	4272	4460
			4634	4922	5498	5853	6041	6235	6416	6604	6778
N93M2OR	Right Arm with Clean Out		2994	3161	3292	3434	3589	3757	3887	4054	4228
			4389	4656	5189	5517	5691	5871	6038	6212	6373
N93M2ORM	Right Mid Arms with Clean Out		3200	3389	3536	3697	3872	4061	4208	4397	4593
			4775	5076	5678	6049	6245	6448	6637	6833	7015
N93M2OL	Left Arm with Clean Out		2994	3161	3292	3434	3589	3757	3887	4054	4228
			4389	4656	5189	5517	5691	5871	6038	6212	6373
N93M2OLM	Left Mid Arms with Clean Out		3200	3389	3536	3697	3872	4061	4208	4397	4593
			4775	5076	5678	6049	6245	6448	6637	6833	7015

DIMENSIONS

Width	51½	Seat Height	18½	Arm Height	27½	Weight	141
Depth	27	Seat Depth	20½	Mid Arm Height	40¼	Weight with Tablet	149
Height	40¼	Seat Width	47½	Back Height	22½	Weight with Mid Arms	149
				Back Width	47½	Cubic Ft.	43.0
						Cubic Ft. with Tablet	47.6

- Power grommet available on front of arm or seat (factory installed); specify grommet option
- Contrasting fabric option – specify X (i.e., N93M2RX); see page 201. For list pricing, use your electronic specification tool or contact customer service
- Accepts upholstered, laminate or veneer divider panels (page 226)
- Upholstered divider panels cannot be added to an existing arm
- Laminate and veneer divider panels can be added to an armless unit, onto the arm of a unit, or replace an existing arm
- Laminate and veneer divider panels cannot be added onto a tablet arm due to interference
- Accepts laminate and veneer back panels (page 227) which will be the height and width of a high back armless model

TO ORDER, SPECIFY:

1. Model Number
2. Fabric Grade / Cover Number
3. Front Arm Grommet
4. Front Seat Grommet
5. Tablet and Finish (when applicable)
6. Leg Color
7. Glides

- See pages 199-200 for Fringe options
- See pages 264-278 for COM fabric yardage

**HIGH BACK
2 SEAT LOUNGE**

**MODEL
NO.**

ALLIANCE PROGRAM PRICE GRADES

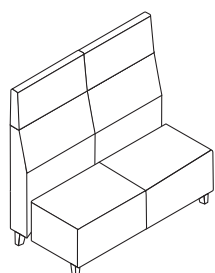

Armless with Clean Out

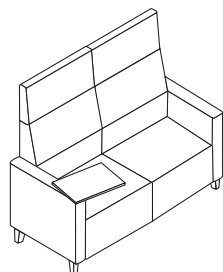

Tablet Right Arm

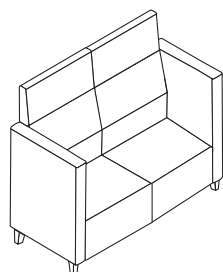

Mid Arms

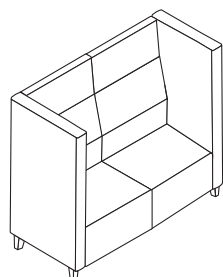

High Arms

		A	B	C	D	E	F	G	H	I
		J	K	L	M	N	O	P	Q	R
N93H2M	Armless	\$ 3761	3898	4005	4123	4250	4388	4495	4633	4775
		4908	5127	5566	5836	5979	6127	6265	6407	6540
N93H2B	Arms	4392	4605	4771	4952	5150	5363	5529	5742	5964
		6169	6509	7188	7607	7828	8057	8270	8492	8697
N93H2BR	Tablet Right Arm	4646	4859	5025	5206	5404	5617	5783	5996	6218
		6423	6763	7442	7861	8082	8311	8524	8746	8951
N93H2BL	Tablet Left Arm	4646	4859	5025	5206	5404	5617	5783	5996	6218
		6423	6763	7442	7861	8082	8311	8524	8746	8951
N93H2BB	Tablet Both Arms	4898	5111	5277	5458	5656	5869	6035	6248	6470
		6675	7015	7694	8113	8334	8563	8776	8998	9203
N93H2BM	Mid Arms	4792	5048	5248	5466	5704	5960	6160	6416	6682
		6929	7338	8155	8658	8924	9200	9456	9722	9969
N93H2BH	High Arms	4909	5203	5432	5682	5955	6249	6478	6772	7078
		7361	7830	8767	9345	9650	9966	10260	10566	10849
N93H2OM	Armless with Clean Out	3848	3994	4107	4231	4366	4512	4626	4771	4923
		5063	5295	5760	6046	6197	6354	6499	6651	6791
N93H2OB	Arms with Clean Out	4489	4710	4883	5071	5276	5498	5670	5891	6121
		6334	6687	7392	7826	8056	8294	8515	8745	8958
N93H2OBM	Mid Arms with Clean Out	4893	5154	5358	5581	5824	6086	6289	6551	6823
		7075	7492	8326	8840	9112	9393	9655	9927	10179
N93H2OBH	High Arms with Clean Out	5016	5318	5554	5811	6091	6394	6629	6931	7245
		7536	8018	8981	9574	9888	10213	10515	10829	11120

DIMENSIONS

Width	47½	Seat Height	18½	Arm Height	27½	Weight	149
Width with Arms	55½	Seat Depth	20½	Mid Arm Height	40%	Weight with Arms	187
Depth	27	Seat Width	47½	High Arm Height	53%	Weight with Tablet	195
Height	53¾			Back Height	35%	Weight with 2 Tablets	200
				Back Width	47%	Weight with Mid Arms	203
						Weight with High Arms	219
						Cubic Ft.	51.3
						Cubic Ft. with Arms	58.3
						Cubic Ft. with Tablet	64.4
						Cubic Ft. with 2 Tablets	66.5

- Power grommet available on front of arm or seat (factory installed); specify grommet option
- Contrasting fabric option – specify X (i.e., N93H2MX); see page 201. For list pricing, use your electronic specification tool or contact customer service
- Accepts upholstered, laminate or veneer divider panels (page 226)
- Upholstered divider panels cannot be added to an existing arm
- Laminate and veneer divider panels can be added to an armless unit, onto the arm of a unit, or replace an existing arm
- Laminate and veneer divider panels cannot be added onto a tablet arm due to interference
- Accepts laminate and veneer back panels (page 227) which will be the height and width of a high back armless model

FRINGE

TO ORDER, SPECIFY:

1. Model Number
2. Fabric Grade / Cover Number
3. Front Arm Grommet
4. Front Seat Grommet
5. Tablet and Finish (when applicable)
6. Leg Color
7. Glides

- See pages 199-200 for Fringe options
- See pages 264-278 for COM fabric yardage

HIGH BACK 2 SEAT LOUNGE SINGLE ARM

MODEL NO.

ALLIANCE PROGRAM PRICE GRADES

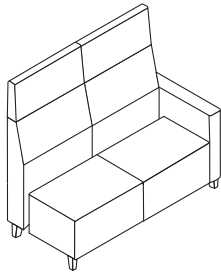

Left Arm with Clean Out

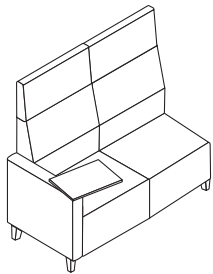

Tablet Right Arm

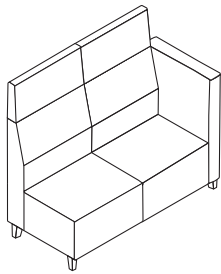

Left Mid Arm

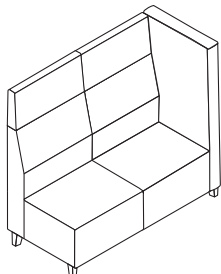

Left High Arm

			A	B	C	D	E	F	G	H	I
			J	K	L	M	N	O	P	Q	R
N93H2R	Right Arm	\$	4086	4266	4407	4561	4729	4910	5050	5231	5419
			5593	5881	6457	6812	7000	7194	7375	7563	7737
N93H2RR	Tablet Right Arm		4338	4518	4659	4813	4981	5162	5302	5483	5671
			5845	6133	6709	7064	7252	7446	7627	7815	7989
N93H2RM	Right Mid Arms		4281	4481	4636	4806	4991	5191	5347	5546	5754
			5946	6264	6901	7293	7500	7715	7914	8122	8314
N93H2RH	Right High Arms		4340	4558	4728	4915	5117	5336	5506	5725	5951
			6162	6510	7207	7636	7863	8098	8317	8543	8754
N93H2L	Left Arm		4086	4266	4407	4561	4729	4910	5050	5231	5419
			5593	5881	6457	6812	7000	7194	7375	7563	7737
N93H2LL	Tablet Left Arm		4338	4518	4659	4813	4981	5162	5302	5483	5671
			5845	6133	6709	7064	7252	7446	7627	7815	7989
N93H2LM	Left Mid Arms		4281	4481	4636	4806	4991	5191	5347	5546	5754
			5946	6264	6901	7293	7500	7715	7914	8122	8314
N93H2LH	Left High Arms		4340	4558	4728	4915	5117	5336	5506	5725	5951
			6162	6510	7207	7636	7863	8098	8317	8543	8754
N93H2OR	Right Arm with Clean Out		4175	4361	4506	4664	4837	5023	5168	5354	5548
			5727	6024	6617	6983	7176	7376	7562	7756	7935
N93H2ORM	Right Mid Arms with Clean Out		4373	4578	4738	4913	5103	5308	5467	5673	5885
			6083	6410	7063	7466	7679	7899	8105	8317	8515
N93H2ORH	Right High Arms with Clean Out		4432	4656	4830	5021	5228	5452	5627	5851	6083
			6299	6656	7370	7810	8042	8283	8507	8739	8955
N93H2OL	Left Arm with Clean Out		4175	4361	4506	4664	4837	5023	5168	5354	5548
			5727	6024	6617	6983	7176	7376	7562	7756	7935
N93H2OLM	Left Mid Arms with Clean Out		4373	4578	4738	4913	5103	5308	5467	5673	5885
			6083	6410	7063	7466	7679	7899	8105	8317	8515
N93H2OLH	Left High Arms with Clean Out		4432	4656	4830	5021	5228	5452	5627	5851	6083
			6299	6656	7370	7810	8042	8283	8507	8739	8955

DIMENSIONS

Width	51½	Seat Height	18½	Arm Height	27½	Weight	168
Depth	27	Seat Depth	20½	Mid Arm Height	40¼	Weight with Tablet	176
Height	53¼	Seat Width	47½	High Arm Height	53¼	Weight with Mid Arms	176
				Back Height	35¼	Weight with High Arms	184
				Back Width	47½	Cubic Ft.	54.8
						Cubic Ft. with Tablet	60.6

- Power grommet available on front of arm or seat (factory installed); specify grommet option
- Contrasting fabric option – specify X (i.e., N93H2RX); see page 201. For list pricing, use your electronic specification tool or contact customer service
- Accepts upholstered, laminate or veneer divider panels (page 226)
- Upholstered divider panels cannot be added to an existing arm
- Laminate and veneer divider panels can be added to an armless unit, onto the arm of a unit, or replace an existing arm
- Laminate and veneer divider panels cannot be added onto a tablet arm due to interference
- Accepts laminate and veneer back panels (page 227) which will be the height and width of a high back armless model

TO ORDER, SPECIFY:

1. Model Number
2. Fabric Grade / Cover Number
3. Front Arm Grommet
4. Front Seat Grommet
5. Tablet and Finish (when applicable)
6. Leg Color
7. Glides

- See pages 199-200 for Fringe options
- See pages 264-278 for COM fabric yardage

**MID BACK
3 SEAT LOUNGE**

**MODEL
NO.**

ALLIANCE PROGRAM PRICE GRADES

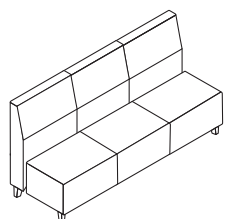

Armless with Clean Out

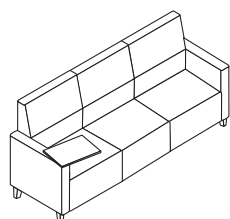

Tablet Right Arm

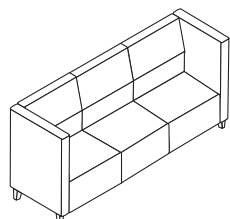

Mid Arms

		A	B	C	D	E	F	G	H	I
		J	K	L	M	N	O	P	Q	R
N93M3M	Armless	\$ 3437	3599	3725	3863	4013	4175	4301	4463	4631
		4787	5045	5561	5879	6047	6221	6383	6551	6707
N93M3B	Arms	4072	4312	4499	4703	4926	5166	5353	5593	5843
		6074	6457	7222	7694	7943	8201	8441	8691	8922
N93M3BR	Tablet Right Arm	4325	4565	4752	4956	5179	5419	5606	5846	6096
		6327	6710	7475	7947	8196	8454	8694	8944	9175
N93M3BL	Tablet Left Arm	4325	4565	4752	4956	5179	5419	5606	5846	6096
		6327	6710	7475	7947	8196	8454	8694	8944	9175
N93M3BB	Tablet Both Arms	4578	4818	5005	5209	5432	5672	5859	6099	6349
		6580	6963	7728	8200	8449	8707	8947	9197	9428
N93M3BM	Mid Arms	4466	4747	4965	5204	5464	5745	5964	6244	6536
		6806	7253	8148	8699	8990	9292	9572	9864	10134
N93M30M	Armless with Clean Out	3527	3702	3839	3988	4151	4326	4463	4638	4820
		4989	5269	5828	6172	6354	6543	6718	6900	7069
N93M30B	Arms with Clean Out	4168	4419	4614	4828	5060	5311	5507	5758	6018
		6260	6660	7460	7953	8213	8483	8734	8994	9236
N93M30BM	Mid Arms with Clean Out	4573	4867	5096	5346	5619	5913	6142	6436	6742
		7025	7494	8431	9009	9314	9630	9924	10230	10513

DIMENSIONS

Width	70%	Seat Height	18½	Arm Height	27%	Weight	163
Width with Arms	78%	Seat Depth	20½	Mid Arm Height	40%	Weight with Arms	201
Depth	27	Seat Width	70%	Back Height	22½	Weight with Tablet	209
Height	40%			Back Width	70%	Weight with 2 Tablets	214
						Weight with Mid Arms	217
						Cubic Ft.	58.3
						Cubic Ft. with Arms	63.8
						Cubic Ft. with Tablet	69.8
						Cubic Ft. with 2 Tablets	71.5

- Power grommet available on front of arm or seat (factory installed); specify grommet option
- Contrasting fabric option – specify X (i.e., N93M3MX); see page 201. For list pricing, use your electronic specification tool or contact customer service
- Accepts upholstered, laminate or veneer divider panels (page 226)
- Upholstered divider panels cannot be added to an existing arm
- Laminate and veneer divider panels can be added to an armless unit, onto the arm of a unit, or replace an existing arm
- Laminate and veneer divider panels cannot be added onto a tablet arm due to interference
- Accepts laminate and veneer back panels (page 227) which will be the height and width of a high back armless model

FRINGE

TO ORDER, SPECIFY:

1. Model Number
2. Fabric Grade / Cover Number
3. Front Arm Grommet
4. Front Seat Grommet
5. Tablet and Finish (when applicable)
6. Leg Color
7. Glides

- See pages 199-200 for Fringe options
- See pages 264-278 for COM fabric yardage

MID BACK 3 SEAT LOUNGE SINGLE ARM

MODEL NO.

ALLIANCE PROGRAM PRICE GRADES

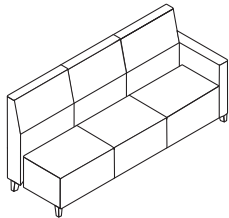

Left Arm with Clean Out

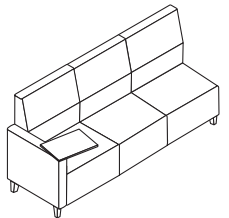

Tablet Right Arm

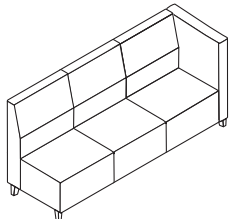

Left Mid Arm

			A	B	C	D	E	F	G	H	I
			J	K	L	M	N	O	P	Q	R
N93M3R	Right Arm	\$	3760	3965	4125	4300	4490	4695	4854	5060	5272
			5470	5797	6450	6853	7066	7286	7492	7704	7902
N93M3RR	Tablet Right Arm		4013	4218	4378	4553	4743	4948	5107	5313	5525
			5723	6050	6703	7106	7319	7539	7745	7957	8155
N93M3RM	Right Mid Arms		3958	4182	4356	4547	4754	4978	5153	5377	5609
			5825	6182	6896	7336	7568	7809	8033	8265	8481
N93M3L	Left Arm		3760	3965	4125	4300	4490	4695	4854	5060	5272
			5470	5797	6450	6853	7066	7286	7492	7704	7902
N93M3LL	Tablet Left Arm		4013	4218	4378	4553	4743	4948	5107	5313	5525
			5723	6050	6703	7106	7319	7539	7745	7957	8155
N93M3LM	Left Mid Arms		3958	4182	4356	4547	4754	4978	5153	5377	5609
			5825	6182	6896	7336	7568	7809	8033	8265	8481
N93M3OR	Right Arm with Clean Out		3855	4073	4243	4430	4632	4851	5021	5240	5466
			5677	6025	6722	7151	7378	7613	7832	8058	8269
N93M3ORM	Right Mid Arms with Clean Out		4054	4292	4476	4679	4899	5136	5321	5559	5805
			6034	6412	7169	7636	7882	8137	8375	8621	8850
N93M3OL	Left Arm with Clean Out		3855	4073	4243	4430	4632	4851	5021	5240	5466
			5677	6025	6722	7151	7378	7613	7832	8058	8269
N93M3OLM	Left Mid Arms with Clean Out		4054	4292	4476	4679	4899	5136	5321	5559	5805
			6034	6412	7169	7636	7882	8137	8375	8621	8850

DIMENSIONS

Width	74¾	Seat Height	18½	Arm Height	27½	Weight	182
Depth	27	Seat Depth	20½	Mid Arm Height	40¾	Weight with Tablet	190
Height	40¾	Seat Width	70¾	Back Height	22½	Weight with Mid Arms	190
				Back Width	70¾	Cubic Ft.	61.1
						Cubic Ft. with Tablet	66.8

- Power grommet available on front of arm or seat (factory installed); specify grommet option
- Contrasting fabric option – specify X (i.e., N93M3RX); see page 201. For list pricing, use your electronic specification tool or contact customer service
- Accepts upholstered, laminate or veneer divider panels (page 226)
- Upholstered divider panels cannot be added to an existing arm
- Laminate and veneer divider panels can be added to an armless unit, onto the arm of a unit, or replace an existing arm
- Laminate and veneer divider panels cannot be added onto a tablet arm due to interference
- Accepts laminate and veneer back panels (page 227) which will be the height and width of a high back armless model

TO ORDER, SPECIFY:

1. Model Number
2. Fabric Grade / Cover Number
3. Front Arm Grommet
4. Front Seat Grommet
5. Tablet and Finish (when applicable)
6. Leg Color
7. Glides

- See pages 199-200 for Fringe options
- See pages 264-278 for COM fabric yardage

**HIGH BACK
3 SEAT LOUNGE**

**MODEL
NO.**

ALLIANCE PROGRAM PRICE GRADES

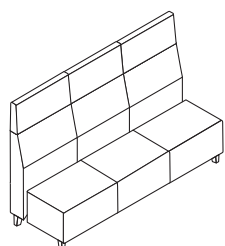

Armless with Clean Out

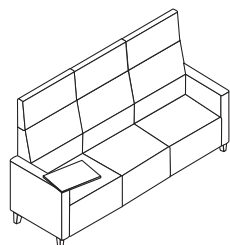

Tablet Right Arm

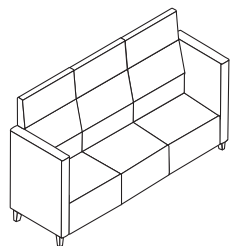

Mid Arms

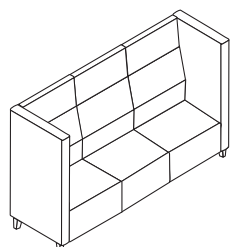

High Arms

		A	B	C	D	E	F	G	H	I
		J	K	L	M	N	O	P	Q	R
N93H3M	Armless	\$ 5172	5363	5512	5676	5853	6045	6194	6386	6584
		6769	7074	7685	8061	8260	8466	8658	8856	9041
N93H3B	Arms	5801	6068	6276	6503	6751	7018	7226	7493	7771
		8028	8454	9305	9830	10107	10394	10661	10939	11196
N93H3BR	Tablet Right Arm	6054	6321	6529	6756	7004	7271	7479	7746	8024
		8281	8707	9558	10083	10360	10647	10914	11192	11449
N93H3BL	Tablet Left Arm	6054	6321	6529	6756	7004	7271	7479	7746	8024
		8281	8707	9558	10083	10360	10647	10914	11192	11449
N93H3BB	Tablet Both Arms	6307	6574	6782	7009	7257	7524	7732	7999	8277
		8534	8960	9811	10336	10613	10900	11167	11445	11702
N93H3BM	Mid Arms	6201	6511	6753	7017	7305	7615	7857	8167	8489
		8788	9283	10272	10881	11203	11537	11847	12169	12468
N93H3BH	High Arms	6319	6667	6938	7234	7557	7905	8176	8524	8886
		9221	9776	10885	11569	11930	12304	12652	13014	13349
N93H3OM	Armless with Clean Out	5296	5501	5661	5836	6026	6231	6390	6596	6808
		7006	7333	7986	8389	8602	8822	9028	9240	9438
N93H3OB	Arms with Clean Out	5936	6217	6435	6674	6934	7215	7434	7714	8006
		8276	8723	9618	10169	10460	10762	11042	11334	11604
N93H3OBM	Mid Arms with Clean Out	6338	6659	6909	7182	7480	7801	8051	8372	8706
		9015	9527	10550	11181	11514	11859	12180	12514	12823
N93H3OBH	High Arms with Clean Out	6461	6823	7104	7412	7747	8109	8391	8752	9128
		9476	10052	11205	11915	12290	12679	13040	13416	13764

DIMENSIONS

Width	70¾	Seat Height	18½	Arm Height	27¼	Weight	204
Width with Arms	78¾	Seat Depth	20½	Mid Arm Height	40¼	Weight with Arms	242
Depth	27	Seat Width	70¾	High Arm Height	53¼	Weight with Tablet	250
Height	53¾			Back Height	35¼	Weight with 2 Tablets	250
				Back Width	70¾	Weight with Mid Arms	258
						Weight with High Arms	274
						Cubic Ft.	74.3
						Cubic Ft. with Arms	81.4
						Cubic Ft. with Tablet	88.9
						Cubic Ft. with 2 Tablets	91.1

- Power grommet available on front of arm or seat (factory installed); specify grommet option
- Contrasting fabric option – specify X (i.e., N93H3MX); see page 201. For list pricing, use your electronic specification tool or contact customer service
- Accepts upholstered, laminate or veneer divider panels (page 226)
- Upholstered divider panels cannot be added to an existing arm
- Laminate and veneer divider panels can be added to an armless unit, onto the arm of a unit, or replace an existing arm
- Laminate and veneer divider panels cannot be added onto a tablet arm due to interference
- Accepts laminate and veneer back panels (page 227) which will be the height and width of a high back armless model

FRINGE

TO ORDER, SPECIFY:

1. Model Number
2. Fabric Grade / Cover Number
3. Front Arm Grommet
4. Front Seat Grommet
5. Tablet and Finish (when applicable)
6. Leg Color
7. Glides

- See pages 199-200 for Fringe options
- See pages 264-278 for COM fabric yardage

HIGH BACK 3 SEAT LOUNGE SINGLE ARM

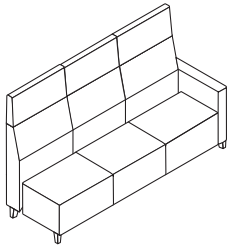

Left Arm with Clean Out

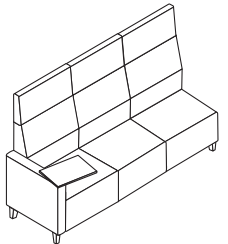

Tablet Right Arm

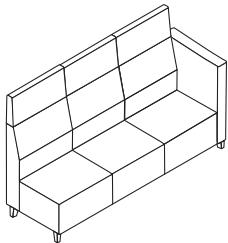

Left Mid Arm

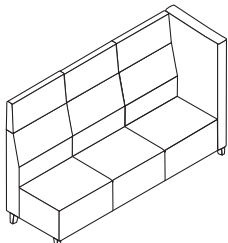

Left High Arm

MODEL NO.

ALLIANCE PROGRAM PRICE GRADES

			A	B	C	D	E	F	G	H	I
			J	K	L	M	N	O	P	Q	R
N93H3R	Right Arm	\$	5495	5729	5912	6112	6330	6565	6747	6982	7226
			7452	7826	8574	9035	9279	9531	9766	10010	10236
N93H3RR	Tablet Right Arm		5747	5981	6164	6364	6582	6817	6999	7234	7478
			7704	8078	8826	9287	9531	9783	10018	10262	10488
N93H3RM	Right Mid Arms		5690	5944	6141	6357	6592	6846	7044	7297	7561
			7805	8209	9018	9516	9779	10052	10305	10569	10813
N93H3RH	Right High Arms		5749	6021	6233	6466	6718	6991	7203	7476	7758
			8021	8455	9324	9859	10142	10435	10708	10990	11253
N93H3L	Left Arm		5495	5729	5912	6112	6330	6565	6747	6982	7226
			7452	7826	8574	9035	9279	9531	9766	10010	10236
N93H3LL	Tablet Left Arm		5747	5981	6164	6364	6582	6817	6999	7234	7478
			7704	8078	8826	9287	9531	9783	10018	10262	10488
N93H3LM	Left Mid Arms		5690	5944	6141	6357	6592	6846	7044	7297	7561
			7805	8209	9018	9516	9779	10052	10305	10569	10813
N93H3LH	Left High Arms		5749	6021	6233	6466	6718	6991	7203	7476	7758
			8021	8455	9324	9859	10142	10435	10708	10990	11253
N93H3OR	Right Arm with Clean Out		5620	5865	6056	6266	6493	6739	6930	7176	7430
			7667	8058	8841	9323	9578	9842	10088	10342	10579
N93H3ORM	Right Mid Arms with Clean Out		5818	6083	6288	6514	6759	7023	7229	7494	7768
			8023	8444	9287	9807	10081	10365	10630	10904	11159
N93H3ORH	Right High Arms with Clean Out		5878	6161	6382	6623	6886	7169	7390	7673	7967
			8240	8692	9595	10151	10445	10750	11033	11327	11600
N93H3OL	Left Arm with Clean Out		5620	5865	6056	6266	6493	6739	6930	7176	7430
			7667	8058	8841	9323	9578	9842	10088	10342	10579
N93H3OLM	Left Mid Arms with Clean Out		5818	6083	6288	6514	6759	7023	7229	7494	7768
			8023	8444	9287	9807	10081	10365	10630	10904	11159
N93H3OLH	Left High Arms with Clean Out		5878	6161	6382	6623	6886	7169	7390	7673	7967
			8240	8692	9595	10151	10445	10750	11033	11327	11600

DIMENSIONS

Width	74¾	Seat Height	18½	Arm Height	27½	Weight	223
Depth	27	Seat Depth	20¾	Mid Arm Height	40¾	Weight with Tablet	231
Height	53¾	Seat Width	70¾	High Arm Height	53¾	Weight with Mid Arms	231
				Back Height	35¾	Weight with High Arms	239
				Back Width	70¾	Cubic Ft.	77.8
						Cubic Ft. with Tablet	85.2

- Power grommet available on front of arm or seat (factory installed); specify grommet option
- Contrasting fabric option – specify X (i.e., N93H3RX); see page 201. For list pricing, use your electronic specification tool or contact customer service
- Accepts upholstered, laminate or veneer divider panels (page 226)
- Upholstered divider panels cannot be added to an existing arm
- Laminate and veneer divider panels can be added to an armless unit, onto the arm of a unit, or replace an existing arm
- Laminate and veneer divider panels cannot be added onto a tablet arm due to interference
- Accepts laminate and veneer back panels (page 227) which will be the height and width of a high back armless model

TO ORDER, SPECIFY:

1. Model Number
2. Fabric Grade / Cover Number
3. Front Seat Grommet
4. Leg Color
5. Glides

- See pages 199-200 for Fringe options
- See pages 264-278 for COM fabric yardage

**MID BACK
2 SEAT COVE LOUNGE**

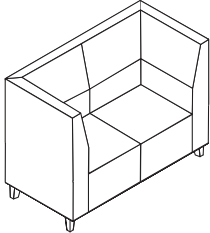

**MODEL
NO.**

ALLIANCE PROGRAM PRICE GRADES

		ALLIANCE PROGRAM PRICE GRADES									
		A	B	C	D	E	F	G	H	I	
		J	K	L	M	N	O	P	Q	R	
N93MC2	Upholstered Back	\$ 4635	4829	4981	5146	5326	5521	5672	5866	6068	
		6255	6565	7184	7565	7767	7976	8170	8372	8559	

DIMENSIONS

Width	53¼	Seat Height	18½	Back Height	22½	Weight	184
Depth	27	Seat Depth	20½	Back Width	53½	Cubic Ft.	45.0
Height	40¼	Seat Width	40				

- Specify grommet option; left, right or both
- Contrasting fabric option – specify X (i.e., N93MC2X); see page 201. For list pricing, use your electronic specification tool or contact customer service

**HIGH BACK
2 SEAT COVE LOUNGE**

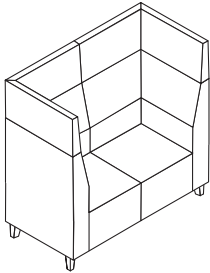

		ALLIANCE PROGRAM PRICE GRADES									
		A	B	C	D	E	F	G	H	I	
		J	K	L	M	N	O	P	Q	R	
N93HC2	Upholstered Back	\$ 6428	6687	6889	7110	7350	7609	7810	8070	8338	
		8588	9001	9826	10335	10604	10882	11142	11410	11660	

DIMENSIONS

Width	53¼	Seat Height	18½	Back Height	35¼	Weight	238
Depth	27	Seat Depth	20½	Back Width	53½	Cubic Ft.	57.3
Height	53¼	Seat Width	40				

- Specify grommet option; left, right or both
- Contrasting fabric option – specify X (i.e., N93HC2X); see page 201. For list pricing, use your electronic specification tool or contact customer service

**MID BACK
3 SEAT COVE LOUNGE**

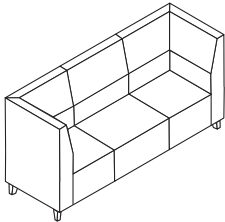

		ALLIANCE PROGRAM PRICE GRADES									
		A	B	C	D	E	F	G	H	I	
		J	K	L	M	N	O	P	Q	R	
N93MC3	Upholstered Back	\$ 6146	6434	6659	6905	7173	7462	7686	7975	8275	
		8553	9013	9933	10500	10800	11110	11399	11699	11977	

DIMENSIONS

Width	77¼	Seat Height	18½	Back Height	22½	Weight	253
Depth	27	Seat Depth	20½	Back Width	79¼	Cubic Ft.	63.0
Height	40¼	Seat Width	64				

- Specify grommet option; left, center, right, combination or all
- Contrasting fabric option – specify X (i.e., N93MC3X); see page 201. For list pricing, use your electronic specification tool or contact customer service

**HIGH BACK
3 SEAT COVE LOUNGE**

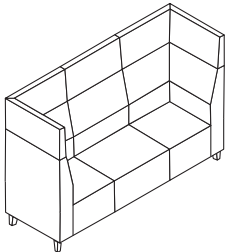

		ALLIANCE PROGRAM PRICE GRADES									
		A	B	C	D	E	F	G	H	I	
		J	K	L	M	N	O	P	Q	R	
N93HC3	Upholstered Back	\$ 8419	8792	9081	9399	9744	10116	10406	10779	11165	
		11524	12117	13304	14036	14422	14822	15195	15581	15940	

DIMENSIONS

Width	77¼	Seat Height	18½	Back Height	35¼	Weight	321
Depth	27	Seat Depth	20½	Back Width	79¼	Cubic Ft.	83.4
Height	53¼	Seat Width	64				

- Specify grommet option; left, center, right, combination or all
- Contrasting fabric option – specify X (i.e., N93HC3X); see page 201. For list pricing, use your electronic specification tool or contact customer service

FRINGE

TO ORDER, SPECIFY:

1. Model Number
2. Fabric Grade / Cover Number
3. Front Seat Grommet
4. Leg Color
5. Glides

- See pages 199-200 for Fringe options
- See pages 264-278 for COM fabric yardage

MID BACK SQUARE 90° CORNER

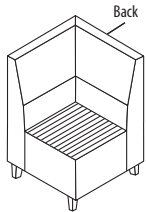

Right

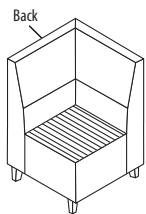

Left

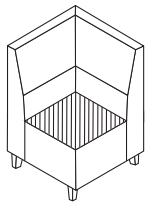

Diagonal
(Vertical Stripe Depicted)

MODEL NO.

ALLIANCE PROGRAM PRICE GRADES

			A	B	C	D	E	F	G	H	I
			J	K	L	M	N	O	P	Q	R
N93MSQ9R	Square 90°, Right	\$	2458	2571	2660	2756	2861	2975	3063	3176	3294
			3403	3584	3945	4167	4285	4407	4520	4638	4747
N93MSQ9L	Square 90°, Left		2458	2571	2660	2756	2861	2975	3063	3176	3294
			3403	3584	3945	4167	4285	4407	4520	4638	4747
N93MSQ9D	Square 90°, Diagonal		2458	2571	2660	2756	2861	2975	3063	3176	3294
			3403	3584	3945	4167	4285	4407	4520	4638	4747

DIMENSIONS

Width	27	Seat Height	18½	Back Height	22½	Weight	92
Depth	27	Seat Depth	20½	Back Width	20½	Cubic Ft.	23.7
Height	40¼	Seat Width	20½				

- Power grommet available on front of seat (factory installed); specify grommet option
- Contrasting fabric option – specify X (i.e., N93MSQ9RX); see page 201. For list pricing, use your electronic specification tool or contact customer service
- Diagonal model is recommended for directional fabrics
- Accepts laminate or veneer corner back panels (page 227)

TO ORDER, SPECIFY:

1. Model Number
2. Fabric Grade / Cover Number
3. Front Seat Grommet
4. Leg Color
5. Glides

- See pages 199-200 for Fringe options
- See pages 264-278 for COM fabric yardage

HIGH BACK SQUARE 90° CORNER

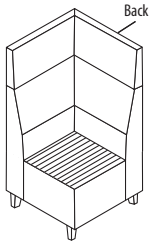

Right

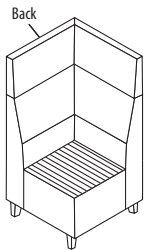

Left

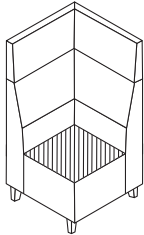

Diagonal
(Vertical Stripe Depicted)

MODEL NO.

ALLIANCE PROGRAM PRICE GRADES

		A	B	C	D	E	F	G	H	I
		J	K	L	M	N	O	P	Q	R
N93HSQ9R	Square 90°, Right	\$ 3399	3545	3658	3782	3917	4063	4177	4322	4474
		4614	4846	5311	5597	5748	5905	6050	6202	6342
N93HSQ9L	Square 90°, Left	3399	3545	3658	3782	3917	4063	4177	4322	4474
		4614	4846	5311	5597	5748	5905	6050	6202	6342
N93HSQ9D	Square 90°, Diagonal	3399	3545	3658	3782	3917	4063	4177	4322	4474
		4614	4846	5311	5597	5748	5905	6050	6202	6342

DIMENSIONS

Width	27	Seat Height	18½	Back Height	22½	Weight	119
Depth	27	Seat Depth	20½	Back Width	20½	Cubic Ft.	30.3
Height	53¼	Seat Width	20½				

- Power grommet available on front of seat (factory installed); specify grommet option
- Contrasting fabric option – specify X (i.e., N93HSQ9RX); see page 201. For list pricing, use your electronic specification tool or contact customer service
- Diagonal model is recommended for directional fabrics
- Accepts laminate or veneer corner back panels (page 227)

FRINGE

TO ORDER, SPECIFY:

1. Model Number
2. Fabric Grade / Cover Number
3. Front Seat Grommet
(not available on round models)
4. Leg Color
5. Glides

- See pages 199-200 for Fringe options
- See pages 264-278 for COM fabric yardage

MID BACK OUTSIDE 90° WEDGE

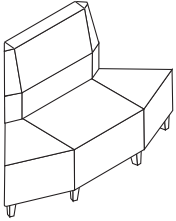

MODEL NO.

ALLIANCE PROGRAM PRICE GRADES

			A	B	C	D	E	F	G	H	I
			J	K	L	M	N	O	P	Q	R
N93MOU9	Outside 90°	\$	2737	2858	2953	3056	3169	3290	3385	3506	3632
			3749	3943	4330	4568	4694	4825	4946	5072	5189

DIMENSIONS

Width	63½	Seat Height	18½	Back Height	22½	Weight	112
Depth	27	Seat Depth	20½	Back Width	34½	Cubic Ft.	57.9
Height	40¼	Seat Width	63½				

- Power grommet available on front of seat (factory installed); specify grommet option
- Contrasting fabric option – specify X (i.e., N93MOU9X); see page 202. For list pricing, use your electronic specification tool or contact customer service
- Accepts laminate or veneer divider panels (page 226)

MID BACK OUTSIDE 90° ROUND

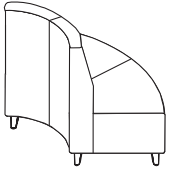

			A	B	C	D	E	F	G	H	I
			J	K	L	M	N	O	P	Q	R
N93MOUR9	Outside 90°	\$	2981	3118	3225	3343	3470	3608	3715	3853	3995
			4128	4347	4786	5056	5199	5347	5485	5627	5760

DIMENSIONS

Width	63½	Seat Height	18½	Back Height	22½	Weight	126
Depth	32	Seat Depth	20½	Back Width	34½	Cubic Ft.	60.2
Height	40¼	Seat Width	63½				

- Power grommet not available
- Contrasting fabric option – specify X (i.e., N93MOUR9X); see page 202. For list pricing, use your electronic specification tool or contact customer service
- Fabrics with distinct pattern do not lend themselves to the curved design of the round models and are not recommended for use on these units
- Accepts laminate or veneer divider panels (page 226)

MID BACK INSIDE 90° WEDGE

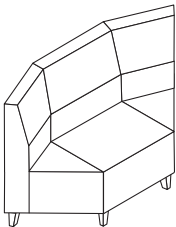

			A	B	C	D	E	F	G	H	I
			J	K	L	M	N	O	P	Q	R
N93MIN9	Inside 90°	\$	2773	2916	3027	3149	3281	3424	3536	3679	3827
			3965	4193	4649	4930	5078	5232	5375	5523	5661

DIMENSIONS

Width	63½	Seat Height	18½	Back Height	22½	Weight	137
Depth	27	Seat Depth	20½	Back Width	60	Cubic Ft.	57.9
Height	40¼	Seat Width	55				

- Power grommet available on front of seat (factory installed); specify grommet option
- Contrasting fabric option – specify X (i.e., N93MIN9X); see page 202. For list pricing, use your electronic specification tool or contact customer service
- Accepts laminate or veneer divider panels (page 226)

MID BACK INSIDE 90° ROUND

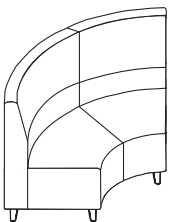

			A	B	C	D	E	F	G	H	I
			J	K	L	M	N	O	P	Q	R
N93MINR9	Inside 90°	\$	3017	3176	3300	3435	3583	3742	3866	4025	4191
			4344	4598	5105	5418	5583	5754	5913	6079	6232

DIMENSIONS

Width	63½	Seat Height	18½	Back Height	22½	Weight	153
Depth	32	Seat Depth	20½	Back Width	60	Cubic Ft.	60.2
Height	40¼	Seat Width	55				

- Power grommet not available
- Contrasting fabric option – specify X (i.e., N93MINR9X); see page 202. For list pricing, use your electronic specification tool or contact customer service
- Fabrics with distinct pattern do not lend themselves to the curved design of the round models and are not recommended for use on these units
- Accepts laminate or veneer divider panels (page 226)

TO ORDER, SPECIFY:

1. Model Number
2. Fabric Grade / Cover Number
3. Front Seat Grommet
(not available on round models)
4. Leg Color
5. Glides

- See pages 199-200 for Fringe options
- See pages 264-278 for COM fabric yardage

**HIGH BACK
OUTSIDE 90°
WEDGE**

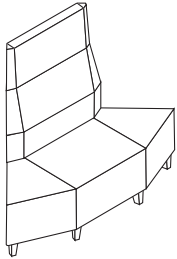

**MODEL
NO.**

ALLIANCE PROGRAM PRICE GRADES

		ALLIANCE PROGRAM PRICE GRADES									
		A	B	C	D	E	F	G	H	I	
		J	K	L	M	N	O	P	Q	R	
N93HOU9	Outside 90°	\$ 3670	3818	3934	4060	4198	4346	4462	4610	4764	
		4907	5144	5617	5908	6062	6222	6370	6524	6667	

DIMENSIONS

Width	63½	Seat Height	18½	Back Height	35¼	Weight	126
Depth	27	Seat Depth	20½	Back Width	34½	Cubic Ft.	73.8
Height	53¼	Seat Width	63½				

- Power grommet available on front of seat (factory installed); specify grommet option
- Contrasting fabric option – specify X (i.e., N93HOU9X); see page 202. For list pricing, use your electronic specification tool or contact customer service
- Accepts laminate or veneer divider panels (page 226)

**HIGH BACK
OUTSIDE 90°
ROUND**

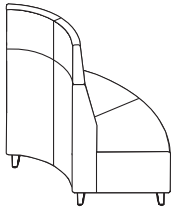

		ALLIANCE PROGRAM PRICE GRADES									
		A	B	C	D	E	F	G	H	I	
		J	K	L	M	N	O	P	Q	R	
N93HOUR9	Outside 90°	\$ 3908	4070	4196	4334	4484	4646	4772	4934	5102	
		5258	5516	6032	6350	6518	6692	6854	7022	7178	

DIMENSIONS

Width	63½	Seat Height	18½	Back Height	35¼	Weight	138
Depth	32	Seat Depth	20½	Back Width	34½	Cubic Ft.	76.7
Height	53¼	Seat Width	63½				

- Power grommet not available
- Contrasting fabric option – specify X (i.e., N93HOUR9X); see page 202. For list pricing, use your electronic specification tool or contact customer service
- Fabrics with distinct pattern do not lend themselves to the curved design of the round models and are not recommended for use on these units
- Accepts laminate or veneer divider panels (page 226)

**HIGH BACK
INSIDE 90°
WEDGE**

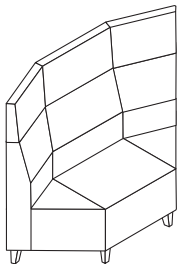

		ALLIANCE PROGRAM PRICE GRADES									
		A	B	C	D	E	F	G	H	I	
		J	K	L	M	N	O	P	Q	R	
N93HIN9	Inside 90°	\$ 3715	3890	4027	4176	4339	4514	4651	4826	5008	
		5177	5457	6016	6360	6542	6731	6906	7088	7257	

DIMENSIONS

Width	63½	Seat Height	18½	Back Height	35¼	Weight	158
Depth	27	Seat Depth	20½	Back Width	60	Cubic Ft.	73.8
Height	53¼	Seat Width	55				

- Power grommet available on front of seat (factory installed); specify grommet option
- Contrasting fabric option – specify X (i.e., N93HIN9X); see page 202. For list pricing, use your electronic specification tool or contact customer service
- Accepts laminate or veneer divider panels (page 226)

**HIGH BACK
INSIDE 90°
ROUND**

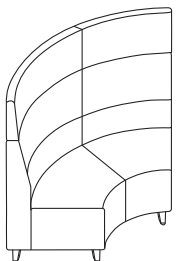

		ALLIANCE PROGRAM PRICE GRADES									
		A	B	C	D	E	F	G	H	I	
		J	K	L	M	N	O	P	Q	R	
N93HINR9	Inside 90°	\$ 3962	4156	4308	4473	4653	4848	4999	5193	5395	
		5582	5892	6511	6892	7094	7303	7497	7699	7886	

DIMENSIONS

Width	63½	Seat Height	18½	Back Height	35¼	Weight	174
Depth	32	Seat Depth	20½	Back Width	60	Cubic Ft.	76.7
Height	53¼	Seat Width	55				

- Power grommet not available
- Contrasting fabric option – specify X (i.e., N93HINR9X); see page 202. For list pricing, use your electronic specification tool or contact customer service
- Fabrics with distinct pattern do not lend themselves to the curved design of the round models and are not recommended for use on these units
- Accepts laminate or veneer divider panels (page 226)

FRINGE

TO ORDER, SPECIFY:

1. Model Number
2. Fabric Grade / Cover Number
3. Front Seat Grommet
4. Leg Color (not on plinth base)
5. Glides

- See pages 199-200 for Fringe options
- See pages 264-278 for COM fabric yardage

MID BACK 1 SEAT SINGLE BOOTH

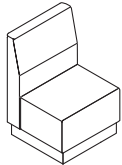

Plinth Base

MODEL NO.

ALLIANCE PROGRAM PRICE GRADES

			A	B	C	D	E	F	G	H	I
			J	K	L	M	N	O	P	Q	R
N93MBH1MSP	Mid Back, Single Booth, Plinth Base	\$	2018	2101	2166	2238	2315	2399	2464	2548	2634
			2715	2848	3115	3279	3366	3456	3540	3626	3707

DIMENSIONS

Width	24	Seat Height	18½	Back Height	22½	Weight	109
Depth	27	Seat Depth	20½	Back Width	24	Cubic Ft.	19.1
Height	40¼	Seat Width	24				

- Ships fully assembled
- Plinth base models do not gang
- Accepts laminate or veneer divider panels and back panels (pages 226-227)

HIGH BACK 1 SEAT SINGLE BOOTH

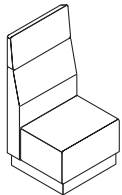

Plinth Base

			A	B	C	D	E	F	G	H	I
			J	K	L	M	N	O	P	Q	R
N93HBH1MSP	High Back, Single Booth, Plinth Base	\$	2571	2660	2729	2805	2887	2976	3046	3135	3227
			3313	3455	3739	3914	4006	4102	4191	4283	4369

DIMENSIONS

Width	24	Seat Height	18½	Back Height	35¼	Weight	123
Depth	27	Seat Depth	20½	Back Width	24	Cubic Ft.	24.7
Height	53¼	Seat Width	24				

- Ships fully assembled
- Plinth base models do not gang
- Accepts laminate or veneer divider panels and back panels (pages 226-227)

MID BACK 1 SEAT DOUBLE BOOTH

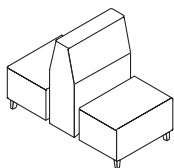

With Clean Out

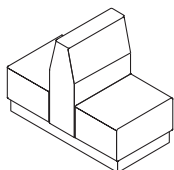

Plinth Base

			A	B	C	D	E	F	G	H	I
			J	K	L	M	N	O	P	Q	R
N93MBH1MD	Mid Back, Double Booth	\$	2478	2594	2684	2783	2890	3006	3097	3213	3333
			3445	3630	4000	4228	4348	4473	4589	4709	4821
N93MBH1OMD	Mid Back, Double Booth with Clean Out		2524	2640	2730	2829	2936	3052	3143	3259	3379
			3491	3676	4046	4274	4394	4519	4635	4755	4867
N93MBH1MDP	Mid Back, Double Booth, Plinth Base		2725	2841	2931	3030	3137	3253	3344	3460	3580
			3692	3877	4247	4475	4595	4720	4836	4956	5068

DIMENSIONS

Width	24	Seat Height	18½	Back Height	22½	Weight	104
Depth	53	Seat Depth	20½	Back Width	24	Cubic Ft.	39.1
Height	40¼	Seat Width	24			Plinth Weight	144
						Plinth Cubic Ft.	36.4

- Ships fully assembled
- Plinth base models do not gang

TO ORDER, SPECIFY:

1. Model Number
2. Fabric Grade / Cover Number
3. Front Seat Grommet
4. Leg Color (not on plinth base)
5. Glides

- See pages 199-200 for Fringe options
- See pages 264-278 for COM fabric yardage

HIGH BACK 1 SEAT DOUBLE BOOTH

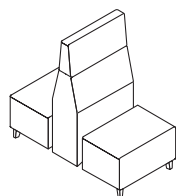

With Clean Out

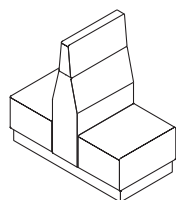

Plinth Base

MODEL NO.

ALLIANCE PROGRAM PRICE GRADES

			A	B	C	D	E	F	G	H	I
			J	K	L	M	N	O	P	Q	R
N93HBH1MD	High Back, Double Booth	\$	3003	3129	3228	3336	3454	3581	3679	3806	3938
			4060	4262	4666	4915	5047	5183	5310	5442	5564
N93HBH1OMD	High Back, Double Booth with Clean Out		3060	3186	3285	3393	3511	3638	3736	3863	3995
			4117	4319	4723	4972	5104	5240	5367	5499	5621
N93HBH1MDP	High Back, Double Booth, Plinth Base		3229	3355	3454	3562	3680	3807	3905	4032	4164
			4286	4488	4892	5141	5273	5409	5536	5668	5790

DIMENSIONS

Width	24	Seat Height	18½	Back Height	22½	Weight	118
Depth	53	Seat Depth	20½	Back Width	24	Cubic Ft.	49.9
Height	53¼	Seat Width	24			Plinth Weight	158
						Plinth Cubic Ft.	46.9

- Ships fully assembled
- Plinth base models do not gang

MID BACK 2 SEAT SINGLE BOOTH

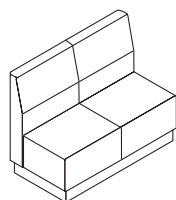

Plinth Base

			A	B	C	D	E	F	G	H	I
			J	K	L	M	N	O	P	Q	R
N93MBH2MSP	Mid Back, Single Booth, Plinth Base	\$	2939	3058	3150	3251	3361	3480	3573	3691	3815
			3929	4118	4497	4730	4853	4981	5099	5223	5337

DIMENSIONS

Width	47½	Seat Height	18½	Back Height	22½	Weight	124
Depth	27	Seat Depth	20½	Back Width	47½	Cubic Ft.	38.9
Height	40¼	Seat Width	47½				

- Ships fully assembled
- Plinth base models do not gang
- Accepts laminate or veneer divider panels and back panels (pages 226-227)

HIGH BACK 2 SEAT SINGLE BOOTH

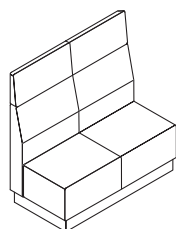

Plinth Base

			A	B	C	D	E	F	G	H	I
			J	K	L	M	N	O	P	Q	R
N93HBH2MSP	High Back, Single Booth, Plinth Base	\$	4095	4232	4339	4457	4584	4722	4829	4967	5109
			5242	5461	5900	6170	6313	6461	6599	6741	6874

DIMENSIONS

Width	47½	Seat Height	18½	Back Height	35¼	Weight	151
Depth	27	Seat Depth	20½	Back Width	47½	Cubic Ft.	50.1
Height	53¼	Seat Width	47½				

- Ships fully assembled
- Plinth base models do not gang
- Accepts laminate or veneer divider panels and back panels (pages 226-227)

FRINGE

TO ORDER, SPECIFY:

1. Model Number
2. Fabric Grade / Cover Number
3. Front Seat Grommet
4. Leg Color (not on plinth base)
5. Glides

- See pages 199-200 for Fringe options
- See pages 264-278 for COM fabric yardage

MID BACK 2 SEAT DOUBLE BOOTH

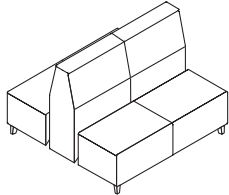

With Clean Out

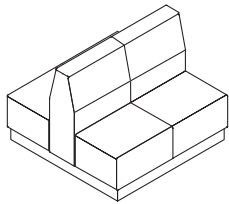

Plinth Base

MODEL NO.

ALLIANCE PROGRAM PRICE GRADES

			A	B	C	D	E	F	G	H	I
			J	K	L	M	N	O	P	Q	R
N93MBH2MD	Mid Back, Double Booth	\$	3602	3764	3890	4028	4178	4340	4466	4628	4796
			4952	5210	5726	6044	6212	6386	6548	6716	6872
N93MBH2OMD	Mid Back, Double Booth with Clean Out		3718	3907	4054	4215	4390	4579	4726	4915	5111
			5293	5594	6196	6567	6763	6966	7155	7351	7533
N93MBH2MDP	Mid Back, Double Booth, Plinth Base		3962	4124	4250	4388	4538	4700	4826	4988	5156
			5312	5570	6086	6404	6572	6746	6908	7076	7232

DIMENSIONS

Width	47½	Seat Height	18½	Back Height	22½	Weight	174
Depth	53	Seat Depth	20½	Back Width	47½	Cubic Ft.	46.9
Height	40¼	Seat Width	47½			Plinth Weight	186
						Plinth Cubic Ft.	44.8

- Double Booth with feet ships KD; some assembly required
- Double Booth with plinth base ships fully assembled
- Plinth base models do not gang

HIGH BACK 2 SEAT DOUBLE BOOTH

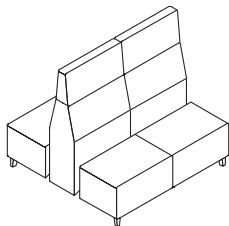

With Clean Out

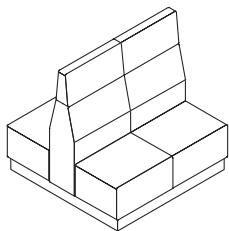

Plinth Base

			A	B	C	D	E	F	G	H	I
			J	K	L	M	N	O	P	Q	R
N93HBH2MD	High Back, Double Booth	\$	4766	4952	5097	5255	5428	5614	5759	5945	6139
			6318	6615	7208	7574	7767	7967	8153	8347	8526
N93HBH2OMD	High Back, Double Booth with Clean Out		4896	5103	5265	5442	5635	5843	6004	6212	6428
			6628	6959	7621	8029	8245	8468	8676	8892	9092
N93HBH2MDP	High Back, Double Booth, Plinth Base		5126	5312	5457	5615	5788	5974	6119	6305	6499
			6678	6975	7568	7934	8127	8327	8513	8707	8886

DIMENSIONS

Width	47½	Seat Height	18½	Back Height	35¼	Weight	207
Depth	53	Seat Depth	20½	Back Width	47½	Cubic Ft.	59.7
Height	53¼	Seat Width	47½			Plinth Weight	219
						Plinth Cubic Ft.	57.7

- Double Booth with feet ships KD; some assembly required
- Double Booth with plinth base ships fully assembled
- Plinth base models do not gang

TO ORDER, SPECIFY:

1. Model Number
2. Fabric Grade / Cover Number
3. Front Seat Grommet
4. Leg Color (not on plinth base)
5. Glides

- See pages 199-200 for Fringe options
- See pages 264-278 for COM fabric yardage

1 SEAT BENCH

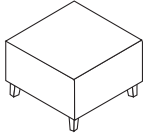

MODEL NO.

ALLIANCE PROGRAM PRICE GRADES

		A	B	C	D	E	F	G	H	I
		J	K	L	M	N	O	P	Q	R
N93B1S27	1 Seat Bench - 27"	\$ 1504	1576	1633	1695	1763	1836	1892	1965	2041
		2111	2227	2459	2602	2678	2756	2829	2905	2975
N93B1S24	1 Seat Bench - 24"	1386	1429	1463	1500	1540	1583	1616	1660	1704
		1746	1815	1952	2037	2082	2128	2172	2216	2258

DIMENSIONS - 27"

Width	27	Weight	40
Depth	27	Cubic Ft.	15.6
Height	18½		

DIMENSIONS - 24"

Width	24	Weight	35
Depth	27	Cubic Ft.	15.6
Height	18½		

- Specify grommet option
- To be used when aligning with 27" depth

- To be used when aligning with 24" depth

¼ ROUND BENCH

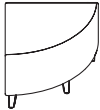

		A	B	C	D	E	F	G	H	I
		J	K	L	M	N	O	P	Q	R
N93BQR27		\$ 1643	1719	1777	1842	1912	1987	2046	2122	2200
		2273	2393	2634	2783	2861	2942	3018	3096	3169

DIMENSIONS

Width	27	Weight	28
Depth	27	Cubic Ft.	10.7
Height	18½		

- Power grommet not available

2 SEAT BENCH

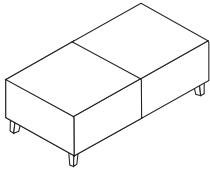

		A	B	C	D	E	F	G	H	I
		J	K	L	M	N	O	P	Q	R
N93B2S54	2 Seat Bench - 53½"	\$ 2024	2143	2235	2336	2446	2565	2658	2776	2900
		3014	3203	3582	3815	3938	4066	4184	4308	4422
N93B2S48	2 Seat Bench - 47½"	1843	1908	1958	2013	2073	2138	2189	2253	2321
		2383	2486	2693	2820	2887	2957	3021	3089	3151

DIMENSIONS - 53½"

Width	53½	Weight	75
Depth	27	Cubic Ft.	23.0
Height	18½		

DIMENSIONS - 47½"

Width	47½	Weight	65
Depth	27	Cubic Ft.	23.0
Height	18½		

- Specify grommet option
- To be used when aligning with 27" depth

- To be used when aligning with 24" depth

½ ROUND BENCH

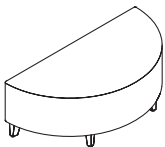

		A	B	C	D	E	F	G	H	I
		J	K	L	M	N	O	P	Q	R
N93BHR54		\$ 2159	2278	2370	2471	2581	2700	2793	2911	3035
		3149	3338	3717	3950	4073	4201	4319	4443	4557

DIMENSIONS

Width	53½	Weight	54
Depth	27	Cubic Ft.	20.5
Height	18½		

- Power grommet not available

FRINGE

TO ORDER, SPECIFY:

1. Model Number
2. Fabric Grade / Cover Number
3. Front Seat Grommet
4. End Seat Grommet
5. Leg Color
6. Glides

- See pages 199-200 for Fringe options
- See pages 264-278 for COM fabric yardage

3 SEAT BENCH

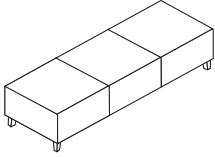

MODEL NO.

ALLIANCE PROGRAM PRICE GRADES

		A	B	C	D	E	F	G	H	I
		J	K	L	M	N	O	P	Q	R
N93B3S80	3 Seat Bench - 79"	\$ 2544	2708	2836	2977	3129	3294	3422	3587	3757
		3916	4178	4703	5026	5197	5374	5539	5709	5868
N93B3S71	3 Seat Bench - 70"	2305	2394	2463	2539	2621	2710	2780	2869	2961
		3047	3189	3473	3648	3740	3836	3925	4017	4103

DIMENSIONS - 79"

Width	79"	Weight	106
Depth	27	Cubic Ft.	33.5
Height	18½		

DIMENSIONS - 70"

Width	70"	Weight	90
Depth	27	Cubic Ft.	33.5
Height	18½		

- Specify grommet option
- To be used when aligning with 27" depth

- To be used when aligning with 24" depth

90° WEDGE

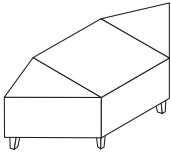

		A	B	C	D	E	F	G	H	I
		J	K	L	M	N	O	P	Q	R
N93BWD64	90° Wedge	\$ 2134	2212	2273	2339	2412	2490	2551	2629	2711
		2786	2911	3160	3314	3395	3479	3557	3639	3714

DIMENSIONS

Width	63½	Weight	81
Depth	27	Cubic Ft.	29.6
Height	18½		

- Power grommet available on front of seat (factory installed); specify grommet option

90° CORNER ROUND

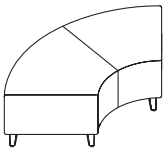

		A	B	C	D	E	F	G	H	I
		J	K	L	M	N	O	P	Q	R
N93BCR64	90° Corner Round	\$ 2372	2464	2535	2613	2698	2790	2862	2953	3049
		3137	3283	3576	3756	3851	3950	4041	4137	4225

DIMENSIONS

Width	63½	Weight	89
Depth	32	Cubic Ft.	29.5
Height	18½		

- Power grommet not available

TO ORDER, SPECIFY:

1. Model Number
2. Fabric Grade / Cover Number
3. Tablet Finish (when applicable)
4. Base Color

- See pages 199-200 for Fringe options
- See pages 264-278 for COM fabric yardage

CLUB CHAIR



Armless Static

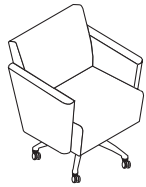

Arms, Mobile

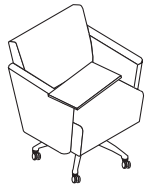

Tablet Right Arm

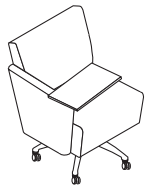

Right Arm, Right Tablet

MODEL NO.

ALLIANCE PROGRAM PRICE GRADES

		A	B	C	D	E	F	G	H	I
		J	K	L	M	N	O	P	Q	R
N93CSM	Armless	\$ 1842	1901	1948	1998	2053	2113	2159	2218	2280
		2337	2432	2621	2737	2799	2863	2922	2984	3041
N93CSMC	Armless, Mobile	1842	1901	1948	1998	2053	2113	2159	2218	2280
		2337	2432	2621	2737	2799	2863	2922	2984	3041
N93CSA	Arms	2427	2519	2590	2668	2753	2845	2917	3008	3104
		3192	3338	3631	3811	3906	4005	4096	4192	4280
N93CSAC	Arms, Mobile	2427	2519	2590	2668	2753	2845	2917	3008	3104
		3192	3338	3631	3811	3906	4005	4096	4192	4280
N93CSAR	Arms, Right Tablet	2694	2786	2857	2935	3020	3112	3184	3275	3371
		3459	3605	3898	4078	4173	4272	4363	4459	4547
N93CSARC	Arms, Right Tablet, Mobile	2694	2786	2857	2935	3020	3112	3184	3275	3371
		3459	3605	3898	4078	4173	4272	4363	4459	4547
N93CSRR	Right Arm, Right Tablet	2398	2474	2532	2597	2667	2742	2801	2877	2955
		3028	3148	3389	3538	3616	3697	3773	3851	3924
N93CSRRC	Right Arm, Right Tablet, Mobile	2398	2474	2532	2597	2667	2742	2801	2877	2955
		3028	3148	3389	3538	3616	3697	3773	3851	3924
N93CSAL	Arms, Left Tablet	2694	2786	2857	2935	3020	3112	3184	3275	3371
		3459	3605	3898	4078	4173	4272	4363	4459	4547
N93CSALC	Arms, Left Tablet, Mobile	2694	2786	2857	2935	3020	3112	3184	3275	3371
		3459	3605	3898	4078	4173	4272	4363	4459	4547
N93CSLL	Left Arm, Left Tablet	2398	2474	2532	2597	2667	2742	2801	2877	2955
		3028	3148	3389	3538	3616	3697	3773	3851	3924
N93CSLLC	Left Arm, Left Tablet, Mobile	2398	2474	2532	2597	2667	2742	2801	2877	2955
		3028	3148	3389	3538	3616	3697	3773	3851	3924

DIMENSIONS

Width	26¼	Seat Height	18½	Arm Height	26¼	Weight	59
Width with Arms	30½	Seat Depth	19	Back Height	18	Weight with Tablet	81
Depth	28	Seat Width	23½	Back Width	23½	Weight with Tablet and 1 Arm	71
Height	34¼					Weight with Tablet and 2 Arms	93
						Cubic Ft.	18.6
						Cubic Ft. with Tablet	20.0
						Cubic Ft. with Arms	21.4

- Static models feature 360° swivel with auto-return
- Contrasting fabric option for arm model – specify X (i.e., N93CSAX); see page 202. For list pricing, use your electronic specification tool or contact customer service

GANGING BRACKET KIT

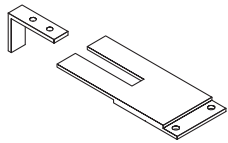

MODEL NO.

LIST PRICE

N93GB2	Ganging Bracket Kit	\$ 74
--------	---------------------	-------

DIMENSIONS

Weight	1.2
Cubic Ft.	1.5

- Ganging bracket kit includes required brackets to join 2 units together
- Once installed, units slide together for a secure connection
- To disconnect, lift up and pull outward

FRINGE

TO ORDER SPECIFY:

1. Model Number
2. Fabric Grade/Cover Number (When Applicable)
3. Arm Grommet (When Applicable)
4. Laminate/Veneer Color (When Applicable)

- See pages 199-200 for Fringe options
- See pages 264-278 for COM fabric yardage

UPHOLSTERED DIVIDER PANEL

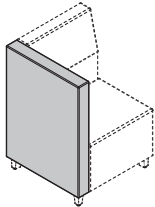

Mid Arm Height

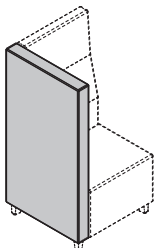

High Arm Height

MODEL NO.

ALLIANCE PROGRAM PRICE GRADES

			A	B	C	D	E	F	G	H	I
			J	K	L	M	N	O	P	Q	R
N93MALU	Mid Arm Height, Left	\$	740	783	817	854	894	937	970	1014	1058
			1100	1169	1306	1391	1436	1482	1526	1570	1612
N93MARU	Mid Arm Height, Right		740	783	817	854	894	937	970	1014	1058
			1100	1169	1306	1391	1436	1482	1526	1570	1612
N93HALU	High Arm Height, Left		868	911	945	982	1022	1065	1098	1142	1186
			1228	1297	1434	1519	1564	1610	1654	1698	1740
N93HARU	High Arm Height, Right		868	911	945	982	1022	1065	1098	1142	1186
			1228	1297	1434	1519	1564	1610	1654	1698	1740

DIMENSIONS

Width	4	Mid Arm Weight	27
Depth	27	High Arm Weight	53
Mid Arm Height	35¾	Mid Arm Cubic Ft.	3.8
High Arm Height	49¾	High Arm Cubic Ft.	4.9

- Upholstered divider panels are able to be attached on either side of a lounge, or in between ganged lounge units within a configuration
- If attaching to an armed unit, arm must be removed before mounting divider panel
- Compatible with one, two and three seat lounge, with the exception of bistro and booth models

DIVIDER PANEL

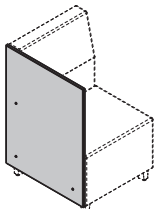

Mid Arm Height

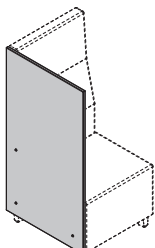

High Arm Height

MODEL NO.

LIST PRICE

N93MALL	Mid Arm Height, Left, Laminate	\$ 475
N93MALW	Mid Arm Height, Left, Veneer	680
N93MARL	Mid Arm Height, Right, Laminate	475
N93MARW	Mid Arm Height, Right, Veneer	680
N93HALL	High Arm Height, Left, Laminate	603
N93HALW	High Arm Height, Left, Veneer	808
N93HARL	High Arm Height, Right, Laminate	603
N93HARW	High Arm Height, Right, Veneer	808

DIMENSIONS

Width	¾	Mid Arm Weight	22
Depth	26½	High Arm Weight	31
Mid Arm Height	36	Mid Arm Cubic Ft.	1.1
High Arm Height	47¾	High Arm Cubic Ft.	1.5

- ¾" edge banded HPL or Veneer
- Attached with silver visible fasteners
- Laminate and Veneer Divider panels are able to be attached on either side of a lounge, or in between lounge units within a configuration
- Divider panels can be attached to an armless unit, or attached to an arm of any height, with the exception of tablet arms
- Divider panels are compatible on one, two and three seat lounge models and single-sided booths
- Divider panels are compatible with bistro models, corners, curves, wedges, and coves

TO ORDER SPECIFY:

1. Model Number
2. Laminate/Veneer Color

• See pages 199-200 for Fringe options

BACK PANEL

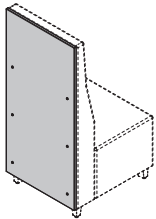
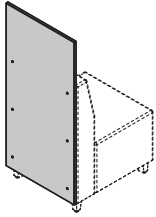

MODEL NO.		LIST PRICE
N93BP1ML	Single Seat, Laminate	\$ 572
N93BP1MW	Single Seat, Veneer	777
N93BP2ML	Two Seat, Laminate	858
N93BP2MW	Two Seat, Veneer	1166
N93BP3ML	Three Seat, Laminate	1288
N93BP3MW	Three Seat, Veneer	1751

DIMENSIONS

Depth	¾	Single Seat Weight	28
Height	47¼	Two Seat Weight	50
Single Seat Width	23¾	Three Seat Weight	73
Two Seat Width	47¾	Two Seat Cubic Ft.	1.4
Three Seat Width	70¾	Three Seat Cubic Ft.	3.2

- ¾" edge banded HPL or Veneer
- Attached with silver visible fasteners
- Back panels are compatible on one, two and three seat lounge models
- When retrofitting a back panel onto a bistro model, the bistro table must be removed for the life of the back panel

SQUARE 90° CORNER BACK PANEL

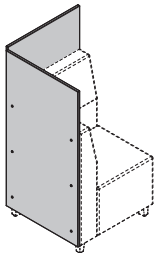

N93BPS9ML	Corner Back Panel, Laminate	\$ 929
N93BPS9MW	Corner Back Panel, Veneer	1168

DIMENSIONS

Width	27¾	Weight	64
Depth	27¾	Cubic Ft.	2.6
Height	47¼		

- ¾" edge banded HPL or Veneer
- Attached with silver visible fasteners

FRINGE BISTRO PRODUCT SPECIFICATIONS

FRAME CONSTRUCTION

- Interior frame is constructed of oriented strand board with tenon joints that are glued and screwed for maximum joint stability
- Each joint is securely glued for maximum stability
- Counterweight installed under seat to ensure stability

SEAT CONSTRUCTION

- Lounge chairs feature 5½" of high grade polyurethane foam covering an oriented strand board seat panel

BACK CONSTRUCTION

- Lounge chairs feature 1½" of high grade custom shaped polyurethane foam stretched over web sheet and attached to frame

ARM REST

- Lounge chairs feature oriented strand board constructed arm frame covered with ¾" high grade polyurethane foam on arm surface and ⅝" on the sides

TABLET ARMS

- ¾" thick laminate with MDF core or ¾" thick plywood with veneer surface
- Attached with ¼" steel base plate with screws that mounts over a ¼" insert rod and fits into structure of arm
- Allows for 360° swivel and writing surface of 17" W x 12" D
- Tablet height is 28½" from floor to top of tablet surface

LEGS AND GLIDES

- Die-cast aluminum legs available in polished or powder coated Concrete, Cinder, Iron, Platinum Metallic, or Satin Nickel Metallic
- Wood legs finished with catalyzed top coat which resists denting, peeling and reactions to chemicals
- Can be cleaned with a damp cloth
- When specifying Brighton, Natural, and Sonoma finish, variation in color is acceptable due to the nature of wood characteristics
- Features a black 1" adjustable leveling glide
- Soft glides are available for an additional upcharge

UPHOLSTERY DETAIL

- Contrasting fabric available on all models, except benches and armless club chair

POWER GROMMET

- Power grommet only available on arm models (factory installed); specify grommet option
- Features 2 electrical receptacles and 2 power USB ports
- Die-cast zinc in black or silver powder coat
- 9 foot, 15 Amp cord
- UL Listed

BISTRO TABLE

FRAME CONSTRUCTION

- Grade A slipmatched maple veneer or HPL and die-cast aluminum brackets
- Veneer features a semi-open pore matte sheen
- 50 lb. weight limit per seat location (i.e., 100 lb. weight limit for 2 seat, 150 lb. weight limit for 3 seat)
- 40" from top of table to floor

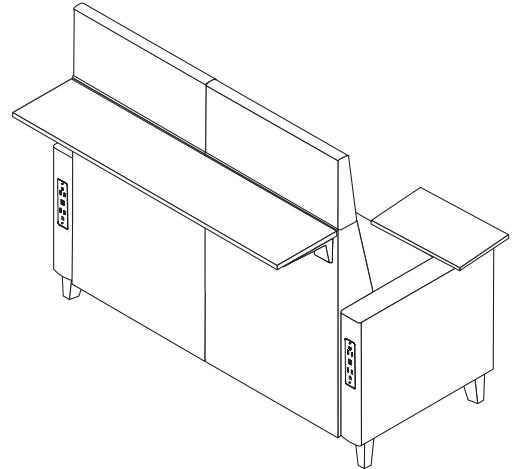

SURFACE MATERIALS

See the Kimball Hospitality Surface Materials Reference Guide at kimballhospitality.com for a complete overview of our materials program, including:

- Characteristics of wood
- Special wood finishes
- Customer-specified laminate (CSL)
- Customer-specified paint (CSP)
- Fabric application and colorways
- Customer's own material (COM) process overview
- Alliance program

ALLIANCE FABRIC PROGRAM

Kimball Hospitality has analyzed each model to most accurately reflect the COM/COL yardage requirements shown on page 264.

The yardage requirement for each model is based on 54" W fabric and cutting the fabric up the roll.

If repeat is larger than 18", contact Customer Service to confirm the correct amount of yardage required. When ordering 10 or more chairs in the same COM, yardage requirements may be reduced.

Contact Customer Service.

PRICE GRADES A-R

See Surface Materials at www.kimballhospitality.com for a wide variety of graded-in fabrics from Arc-Com, CF Stinson, Designtex, Maharam, Momentum, and Ultrafabrics.

FABRIC SAMPLES

If you need samples for presentation(s), contact our alliance partners directly at:

Arc-Com	800.223.5466	arc-com.com
Designtex	800.221.1540	designtex.com
CF Stinson	800.841.6279	cfstinson.com
Maharam	800.645.3943	maharam.com
Momentum	800.366.6839	memosamples.com
Ultrafabrics	877.309.6648	ultrafabricsllc.com

TABLET ARM/BISTRO TABLE

LAMINATE

LAC2	Laminate, Autumn 2
LAD	Laminate, Almond
LCL	Laminate, Caramel
LCW	Laminate, Cordovan
LDW	Laminate, Judicial
LHN2	Laminate, Honey 2
LIM	Laminate, Brighton
LMC	Laminate, Amber
LMH	Laminate, Mocha
LNM	Laminate, Natural
LPB	Laminate, Portobello
LPT	Laminate, Portico
LSK	Laminate, Skyline
LSM	Laminate, Sonoma
LTF	Laminate, Truffle
L405	Laminate, Designer White
L419	Laminate, Wallaby
L425	Laminate, Shadow
L440	Laminate, Cloud
L461	Laminate, Graphite
L462	Laminate, Cinder
L478	Laminate, Platinum Grey
L488	Laminate, Frosty White
L491	Laminate, Designer White Linear
L492	Laminate, Cinder Linear
L792	Laminate, Sable
L793	Laminate, Acorn†

†Acorn is the wood and laminate complement to Clear Walnut finish

WOOD

WAC	Wood, Autumn
WAD	Wood, Almond**
WCL	Wood, Caramel
WCW	Wood, Cordovan
WDW	Wood, Judicial
WHN	Wood, Honey
WIM	Wood, Brighton
WMC	Wood, Amber
WMH	Wood, Mocha
WNM	Wood, Natural
WPB	Wood, Portobello**
WPT	Wood, Portico**
WSK	Wood, Skyline**
WSM	Wood, Sonoma**
WTF	Wood, Truffle
W405	Wood, Designer White
W462	Wood, Cinder
W792	Wood, Sable
W793	Wood, Acorn**†

**Not available on Bistro Table

GALLERY LAMINATE

Grade 1 – 5% upcharge	
LG1001	Laminate, Citadel
LG1011	Laminate, Pepperdust
Grade 2 – 6% upcharge	
LG1002	Laminate, Planked Raw Oak
LG1003	Laminate, Evening Notte
LG1004	Laminate, Kirsche
LG1005	Laminate, Midnight Run
LG1006	Laminate, Sepia Walnut
LG1007	Laminate, Serotina
LG1008	Laminate, Timeless
LG1009	Laminate, White Nebbia
LG1012	Laminate, Phantom Ecu

See page 20 for Gallery program details and upcharges

VENEER FINISHES - BACK PANELS

AC	Autumn	MH	Mocha
CL	Caramel	NM	Natural
CW	Cordovan	TF	Truffle
DW	Judicial	405	Designer White
HN	Honey	462	Cinder
IM	Brighton	792	Sable
MC	Amber		

LAMINATES - BACK PANELS

AC2	Autumn 2	TF	Truffle
AD	Almond	405	Designer White
CL	Caramel	419	Wallaby
CW	Cordovan	425	Shadow
DW	Judicial	440	Cloud
HN2	Honey 2	461	Graphite
IM	Brighton	462	Cinder
MC	Amber	478	Platinum Grey
MH	Mocha	488	Frosty White
NM	Natural	491	Designer White
PB	Portobello		Linear
PT	Portico	492	Cinder Linear
SK	Skyline	792	Sable
SM	Sonoma	793	Acorn†

†Acorn is the finish complement to Clear Walnut finish

GALLERY LAMINATE - BACK PANELS

Grade 1 – 5% upcharge	
G1001	Citadel
G1011	Pepperdust
Grade 2 – 6% upcharge	
G1002	Planked Raw Oak
G1003	Evening Notte
G1004	Kirsche
G1005	Midnight Run
G1006	Sepia Walnut
G1007	Serotina
G1008	Timeless
G1009	White Nebbia
G1012	Phantom Ecu

FRINGE

GLIDES

- STD Standard
- C10 Soft (add \$30 list)

POWER GROMMET OPTIONS

(\$524 list upcharge per location)

- G23BL Black, Left
- G23BR Black, Right
- G23BLR Black, Left & Right
- G23SL Silver, Left
- G23SR Silver, Right
- G23SLR Silver, Left & Right
- X No Grommet

WORKSURFACE MID BACK INSIDE 90° ROUND SURFACE GROMMET OPTIONS

(\$25 list upcharge per location)

- G1C Round Grommet, Center
- X No Grommet

LEG/BASE COLORS

METAL

- 423 Concrete
- 462 Cinder
- 463 Iron
- 497 Polished Aluminum
- 501 Platinum Metallic
- 503 Satin Nickel Metallic

WOOD (\$150 LIST UPCHARGE PER CHAIR)

- | | | | |
|-----|----------|------|--------------------|
| WAC | Autumn | WNM | Natural |
| WAD | Almond | WPB | Portobello |
| WCL | Caramel | WPT | Portico |
| WCW | Cordovan | WSK | Skyline |
| WDW | Judicial | WTF | Truffle |
| WHN | Honey | W405 | Designer White |
| WIM | Brighton | W462 | Cinder |
| WMC | Amber | W792 | Sable |
| WMH | Mocha | W793 | Acorn [†] |

[†]Acorn is the wood complement to Clear Walnut finish

BISTRO WITH POWER GROMMETS

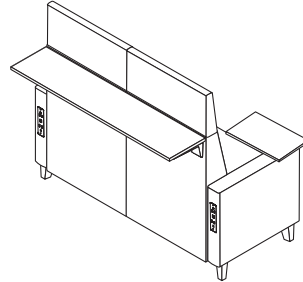
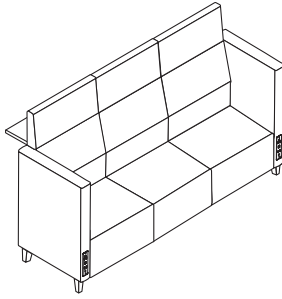

METAL BRACKETS

- 423 Concrete
- 462 Cinder
- 463 Iron
- 497 Polished Aluminum
- 501 Platinum Metallic
- 503 Satin Nickel Metallic

FRINGE

- Bistro Table Mid Back 2 Seat Lounge page 232**
- Bistro Table Mid Back 2 Seat Lounge Single Arm page 233**
- Bistro Table Mid Back 3 Seat Lounge page 237**
- Bistro Table Mid Back 3 Seat Lounge Single Arm page 238**

1. Model Number plus "X"
2. Back Fabric Grade Number/Cover Number
3. Lumbar Fabric Grade Number/Cover Number
4. Extreme Back Grade Number/Cover Number
5. Seat Fabric Grade Number/Cover Number
6. Arm Fabric Grade Number/Cover Number
7. Power Grommet - Front of Arm
8. Power Grommet - Back of Arm
9. Bistro Table Finish
10. Tablet and Finish (when applicable)
11. Finish/Laminate
12. Leg Color
13. Glides

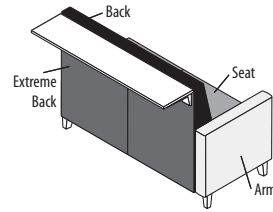

Contrasting Upholstery - Upholstery Back

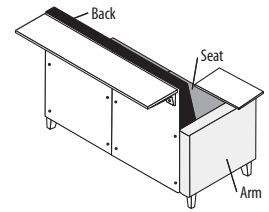

Contrasting Upholstery - Veneer or Laminate Back

- Bistro Table High Back 2 Seat Lounge page 234**
- Bistro Table High Back 2 Seat Lounge Single Arm page 235**
- Bistro Table High Back 3 Seat Lounge page 239**
- Bistro Table High Back 3 Seat Lounge Single Arm page 241**

1. Model Number plus "X"
2. Back Fabric Grade Number/Cover Number
3. Lumbar Fabric Grade Number/Cover Number
4. Extreme Back Grade Number/Cover Number
5. Seat Fabric Grade Number/Cover Number
6. Arm Fabric Grade Number/Cover Number
7. Accent (headrest) Fabric Grade Number/Cover Number
8. Power Grommet - Front of Arm
9. Power Grommet - Back of Arm
10. Bistro Table Finish
11. Tablet and Finish (when applicable)
12. Finish/Laminate
13. Leg Color
14. Glides

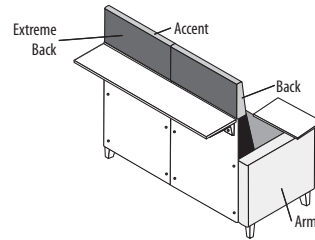

Contrasting Upholstery - Veneer or Laminate Back

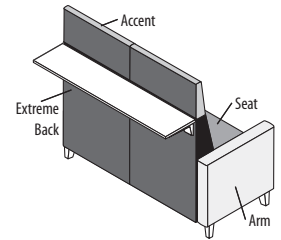

Contrasting Upholstery - Upholstered Back

- Bistro Table Mid Back 2 Seat Cove page 243**
- Bistro Table High Back 2 Seat Cove page 243**
- Bistro Table Mid Back 3 Seat Cove page 244**
- Bistro Table High Back 3 Seat Cove page 244**
- Bistro Table Mid Back Square 90° Corner page 245**
- Bistro Table High Back Square 90° Corner page 246**
- Bistro Table Mid Back Inside 90° Wedge page 247**
- Bistro Table Mid Back Inside 90° Round page 247**
- Worksurface Mid Back Inside 90° Round page 247**
- Bistro Table High Back Inside 90° Wedge page 248**
- Bistro Table High Back Inside 90° Round page 248**

1. Model Number plus "X"
2. Back Fabric Grade Number/Cover Number
3. Lumbar Fabric Grade Number/Cover Number
4. Extreme Back Grade Number/Cover Number
5. Seat Fabric Grade Number/Cover Number
6. Accent (headrest) Fabric Grade Number/Cover Number (when applicable)
7. Bistro Table Finish
8. Finish/Laminate (when applicable)
9. Leg Color
10. Glides

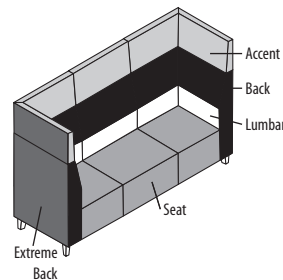

Contrasting Upholstery

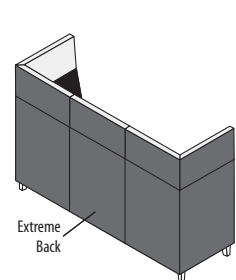

Contrasting Upholstery Back View

FRINGE

TO ORDER, SPECIFY:

1. Model Number
2. Fabric Grade / Cover Number
3. Power Grommet - Front of Arm
4. Power Grommet - Back of Arm
5. Bistro Table Finish
6. Tablet and Finish (when applicable)
7. Finish/Laminate
8. Metal Bracket Color
9. Leg Color
10. Glides

- See pages 229-230 for Fringe options
- See pages 264-278 for COM fabric yardage

BISTRO TABLE MID BACK 2 SEAT LOUNGE

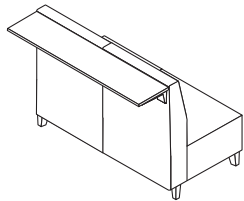

Armless - Upholstered Back

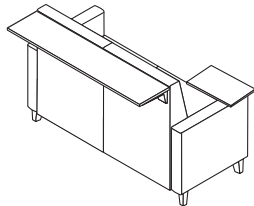

Tablet Right Arm - Upholstered Back

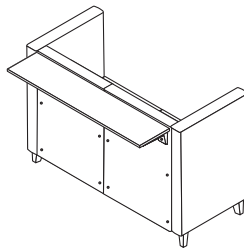

Mid Arms - Veneer or Laminate Back

MODEL NO.

ALLIANCE PROGRAM PRICE GRADES

			A	B	C	D	E	F	G	H	I
			J	K	L	M	N	O	P	Q	R
UPHOLSTERED BACK											
N93MTU2M	Armless, Upholstered Back	\$	3504	3623	3715	3816	3926	4045	4138	4256	4380
			4494	4683	5062	5295	5418	5546	5664	5788	5902
N93MTU2B	Arms, Upholstered Back		4137	4331	4483	4648	4828	5023	5174	5368	5570
			5757	6067	6686	7067	7269	7478	7672	7874	8061
N93MTU2BR	Tablet Right Arm, Upholstered Back		4388	4582	4734	4899	5079	5274	5425	5619	5821
			6008	6318	6937	7318	7520	7729	7923	8125	8312
N93MTU2BL	Tablet Left Arm, Upholstered Back		4388	4582	4734	4899	5079	5274	5425	5619	5821
			6008	6318	6937	7318	7520	7729	7923	8125	8312
N93MTU2BB	Tablet Both Arms, Upholstered Back		4641	4835	4987	5152	5332	5527	5678	5872	6074
			6261	6571	7190	7571	7773	7982	8176	8378	8565
N93MTU2BM	Mid Arms, Upholstered Back		4535	4773	4957	5160	5380	5617	5802	6040	6286
			6515	6893	7650	8117	8363	8618	8856	9102	9331
LAMINATE BACK											
N93MTL2M	Armless, Laminate Back	\$	4362	4456	4530	4610	4698	4792	4866	4960	5058
			5149	5300	5601	5786	5884	5986	6080	6178	6269
N93MTL2B	Arms, Laminate Back		4995	5165	5297	5442	5599	5769	5902	6072	6248
			6412	6683	7225	7559	7735	7918	8088	8264	8428
N93MTL2BR	Tablet Right Arm, Laminate Back		5248	5418	5550	5695	5852	6022	6155	6325	6501
			6665	6936	7478	7812	7988	8171	8341	8517	8681
N93MTL2BL	Tablet Left Arm, Laminate Back		5248	5418	5550	5695	5852	6022	6155	6325	6501
			6665	6936	7478	7812	7988	8171	8341	8517	8681
N93MTL2BB	Tablet Both Arms, Laminate Back		5500	5670	5802	5947	6104	6274	6407	6577	6753
			6917	7188	7730	8064	8240	8423	8593	8769	8933
N93MTL2BM	Mid Arms, Laminate Back		5394	5607	5773	5954	6152	6365	6531	6744	6966
			7171	7511	8190	8609	8830	9059	9272	9494	9699
VENEER BACK											
N93MTW2M	Armless, Veneer Back	\$	4362	4456	4530	4610	4698	4792	4866	4960	5058
			5149	5300	5601	5786	5884	5986	6080	6178	6269
N93MTW2B	Arms, Veneer Back		4995	5165	5297	5442	5599	5769	5902	6072	6248
			6412	6683	7225	7559	7735	7918	8088	8264	8428
N93MTW2BR	Tablet Right Arm, Veneer Back		5248	5418	5550	5695	5852	6022	6155	6325	6501
			6665	6936	7478	7812	7988	8171	8341	8517	8681
N93MTW2BL	Tablet Left Arm, Veneer Back		5248	5418	5550	5695	5852	6022	6155	6325	6501
			6665	6936	7478	7812	7988	8171	8341	8517	8681
N93MTW2BB	Tablet Both Arms, Veneer Back		5500	5670	5802	5947	6104	6274	6407	6577	6753
			6917	7188	7730	8064	8240	8423	8593	8769	8933
N93MTW2BM	Mid Arms, Veneer Back		5394	5607	5773	5954	6152	6365	6531	6744	6966
			7171	7511	8190	8609	8830	9059	9272	9494	9699

DIMENSIONS

Width	47½	Seat Height	18½	Arm Height	27½	Weight	187
Width with Arms	55½	Seat Depth	20½	Mid Arm Height	40%	Weight with Arms	225
Depth	39	Seat Width	47½	Back Height	22½	Weight with Tablet	232
Height	40¼			Back Width	47½	Weight with 2 Tablets	237
						Weight with Mid Arms	241
						Cubic Ft.	40.2
						Cubic Ft. with Arms	45.8
						Cubic Ft. with Tablet	50.5
						Cubic Ft. with 2 Tablets	52.2

- Power grommet only available on arm models (factory installed); specify grommet option
- Power unavailable on front on bistro model seats due to built-in counterweight that ensures the stability of the unit
- Contrasting fabric option – specify X (i.e., N93MTU2MX); see page 231. For list pricing, use your electronic specification tool or contact customer service
- Add 28.75 lbs. for laminate and veneer back models
- Some assembly required
- Accepts laminate and veneer divider panels (page 226)
- Laminate and veneer divider panels can be added to an armless unit, onto the arm of a unit, or replace an existing arm
- Laminate and veneer divider panels cannot be added onto a tablet arm due to interference
- Accepts laminate and veneer back panels (page 227) which will be the height and width of a high back armless model

TO ORDER, SPECIFY:

- 1. Model Number
- 2. Fabric Grade / Cover Number
- 3. Power Grommet - Front of Arm
- 4. Power Grommet - Back of Arm
- 5. Bistro Table Finish
- 6. Tablet and Finish (when applicable)
- 7. Finish/Laminate
- 8. Metal Bracket Color
- 9. Leg Color
- 10. Glides

- See pages 229-230 for Fringe options
- See pages 264-278 for COM fabric yardage

**BISTRO TABLE
MID BACK
2 SEAT LOUNGE
SINGLE ARM**

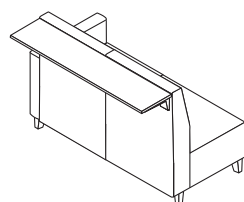

Left Arm - Upholstered Back

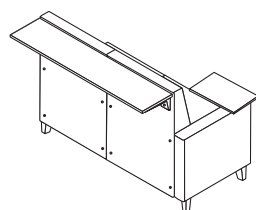

Tablet Right Arm - Veneer or Laminate Back

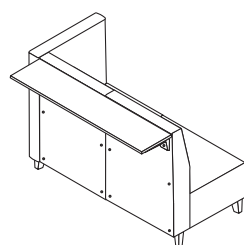

Left Mid Arms - Veneer or Laminate Back

MODEL NO.

ALLIANCE PROGRAM PRICE GRADES

		A	B	C	D	E	F	G	H	I
		J	K	L	M	N	O	P	Q	R
UPHOLSTERED BACK										
N93MTU2R	Right Arm, Upholstered Back	\$ 3830	3992	4118	4256	4406	4568	4694	4856	5024
		5180	5438	5954	6272	6440	6614	6776	6944	7100
N93MTU2RR	Tablet Right Arm, Upholstered Back	4083	4245	4371	4509	4659	4821	4947	5109	5277
		5433	5691	6207	6525	6693	6867	7029	7197	7353
N93MTU2RM	Right Mid Arms, Upholstered Back	4025	4205	4346	4500	4668	4849	4989	5170	5358
		5532	5820	6396	6751	6939	7133	7314	7502	7676
N93MTU2L	Left Arm, Upholstered Back	3830	3992	4118	4256	4406	4568	4694	4856	5024
		5180	5438	5954	6272	6440	6614	6776	6944	7100
N93MTU2LL	Tablet Left Arm, Upholstered Back	4083	4245	4371	4509	4659	4821	4947	5109	5277
		5433	5691	6207	6525	6693	6867	7029	7197	7353
N93MTU2LM	Left Mid Arms, Upholstered Back	4025	4205	4346	4500	4668	4849	4989	5170	5358
		5532	5820	6396	6751	6939	7133	7314	7502	7676
LAMINATE BACK										
N93MTL2R	Right Arm, Laminate Back	\$ 4687	4824	4931	5049	5176	5314	5421	5559	5701
		5834	6053	6492	6762	6905	7053	7191	7333	7466
N93MTL2RR	Tablet Right Arm, Laminate Back	4941	5078	5185	5303	5430	5568	5675	5813	5955
		6088	6307	6746	7016	7159	7307	7445	7587	7720
N93MTL2RM	Right Mid Arms, Laminate Back	4882	5039	5160	5294	5439	5595	5717	5874	6036
		6187	6436	6935	7243	7405	7573	7730	7892	8043
N93MTL2L	Left Arm, Laminate Back	4687	4824	4931	5049	5176	5314	5421	5559	5701
		5834	6053	6492	6762	6905	7053	7191	7333	7466
N93MTL2LL	Tablet Left Arm, Laminate Back	4941	5078	5185	5303	5430	5568	5675	5813	5955
		6088	6307	6746	7016	7159	7307	7445	7587	7720
N93MTL2LM	Left Mid Arms, Laminate Back	4882	5039	5160	5294	5439	5595	5717	5874	6036
		6187	6436	6935	7243	7405	7573	7730	7892	8043
VENEER BACK										
N93MTW2R	Right Arm, Veneer Back	\$ 4687	4824	4931	5049	5176	5314	5421	5559	5701
		5834	6053	6492	6762	6905	7053	7191	7333	7466
N93MTW2RR	Tablet Right Arm, Veneer Back	4941	5078	5185	5303	5430	5568	5675	5813	5955
		6088	6307	6746	7016	7159	7307	7445	7587	7720
N93MTW2RM	Right Mid Arms, Veneer Back	4882	5039	5160	5294	5439	5595	5717	5874	6036
		6187	6436	6935	7243	7405	7573	7730	7892	8043
N93MTW2L	Left Arm, Veneer Back	4687	4824	4931	5049	5176	5314	5421	5559	5701
		5834	6053	6492	6762	6905	7053	7191	7333	7466
N93MTW2LL	Tablet Left Arm, Veneer Back	4941	5078	5185	5303	5430	5568	5675	5813	5955
		6088	6307	6746	7016	7159	7307	7445	7587	7720
N93MTW2LM	Left Mid Arms, Veneer Back	4882	5039	5160	5294	5439	5595	5717	5874	6036
		6187	6436	6935	7243	7405	7573	7730	7892	8043

DIMENSIONS

Width	51½	Seat Height	18½	Arm Height	27½	Weight	206
Depth	39	Seat Depth	20½	Mid Arm Height	40¼	Weight with Tablet	213
Height	40¼	Seat Width	47½	Back Height	22½	Weight with Mid Arms	214
				Back Width	47½	Cubic Ft.	40.2
						Cubic Ft. with Tablet	47.6

- Power grommet only available on arm models (factory installed); specify grommet option
- Power unavailable on front on bistro model seats due to built-in counterweight that ensures the stability of the unit
- Contrasting fabric option – specify X (i.e., N93MTU2RX); see page 231. For list pricing, use your electronic specification tool or contact customer service
- Add 28.75 lbs. for laminate and veneer back models
- Some assembly required
- Accepts laminate and veneer divider panels (page 226)
- Laminate and veneer divider panels can be added to an armless unit, onto the arm of a unit, or replace an existing arm
- Laminate and veneer divider panels cannot be added onto a tablet arm due to interference
- Accepts laminate and veneer back panels (page 227) which will be the height and width of a high back armless model

FRINGE

TO ORDER, SPECIFY:

1. Model Number
2. Fabric Grade / Cover Number
3. Power Grommet - Front of Arm
4. Power Grommet - Back of Arm
5. Bistro Table Finish
6. Tablet and Finish (when applicable)
7. Finish/Laminate
8. Metal Bracket Color
9. Leg Color
10. Glides

- See pages 229-230 for Fringe options
- See pages 264-278 for COM fabric yardage

BISTRO TABLE HIGH BACK 2 SEAT LOUNGE

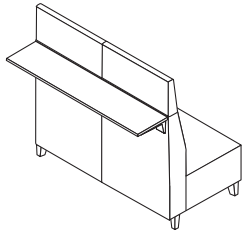

Armless - Upholstered Back

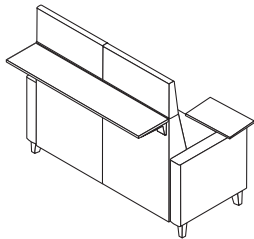

Tablet Right Arm - Upholstered Back

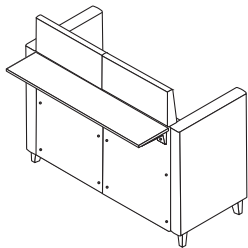

Mid Arms - Veneer or Laminate Back

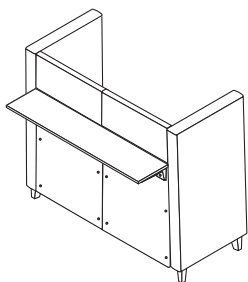

High Arms - Veneer or Laminate Back

MODEL NO.

ALLIANCE PROGRAM PRICE GRADES

			A	B	C	D	E	F	G	H	I
			J	K	L	M	N	O	P	Q	R
UPHOLSTERED BACK											
N93HTU2M	Armless, Upholstered Back	\$	4659	4796	4903	5021	5148	5286	5393	5531	5673
			5806	6025	6464	6734	6877	7025	7163	7305	7438
N93HTU2B	Arms, Upholstered Back		5292	5505	5671	5852	6050	6263	6429	6642	6864
			7069	7409	8088	8507	8728	8957	9170	9392	9597
N93HTU2BR	Tablet Right Arm, Upholstered Back		5545	5758	5924	6105	6303	6516	6682	6895	7117
			7322	7662	8341	8760	8981	9210	9423	9645	9850
N93HTU2BL	Tablet Left Arm, Upholstered Back		5545	5758	5924	6105	6303	6516	6682	6895	7117
			7322	7662	8341	8760	8981	9210	9423	9645	9850
N93HTU2BB	Tablet Both Arms, Upholstered Back		5795	6008	6174	6355	6553	6766	6932	7145	7367
			7572	7912	8591	9010	9231	9460	9673	9895	10100
N93HTU2BM	Mid Arms, Upholstered Back		5690	5946	6146	6364	6602	6858	7058	7314	7580
			7827	8236	9053	9556	9822	10098	10354	10620	10867
N93HTU2BH	High Arms, Upholstered Back		5807	6101	6330	6580	6853	7147	7376	7670	7976
			8259	8728	9665	10243	10548	10864	11158	11464	11747
LAMINATE BACK											
N93HTL2M	Armless, Laminate Back	\$	5522	5638	5728	5827	5934	6050	6141	6257	6377
			6489	6674	7044	7272	7392	7517	7633	7753	7865
N93HTL2B	Arms, Laminate Back		6153	6344	6493	6657	6834	7026	7175	7367	7565
			7750	8055	8666	9042	9241	9447	9639	9837	10022
N93HTL2BR	Tablet Right Arm, Laminate Back		6406	6597	6746	6910	7087	7279	7428	7620	7818
			8003	8308	8919	9295	9494	9700	9892	10090	10275
N93HTL2BL	Tablet Left Arm, Laminate Back		6406	6597	6746	6910	7087	7279	7428	7620	7818
			8003	8308	8919	9295	9494	9700	9892	10090	10275
N93HTL2BB	Tablet Both Arms, Laminate Back		6658	6849	6998	7162	7339	7531	7680	7872	8070
			8255	8560	9171	9547	9746	9952	10144	10342	10527
N93HTL2BM	Mid Arms, Laminate Back		6598	6859	7063	7286	7529	7791	7994	8256	8528
			8780	9197	10031	10545	10817	11098	11360	11632	11884
N93HTL2BH	High Arms, Laminate Back		6670	6942	7154	7387	7639	7912	8124	8397	8679
			8942	9376	10245	10780	11063	11356	11629	11911	12174
VENEER BACK											
N93HTW2M	Armless, Veneer Back	\$	5522	5638	5728	5827	5934	6050	6141	6257	6377
			6489	6674	7044	7272	7392	7517	7633	7753	7865
N93HTW2B	Arms, Veneer Back		6153	6344	6493	6657	6834	7026	7175	7367	7565
			7750	8055	8666	9042	9241	9447	9639	9837	10022
N93HTW2BR	Tablet Right Arm, Veneer Back		6406	6597	6746	6910	7087	7279	7428	7620	7818
			8003	8308	8919	9295	9494	9700	9892	10090	10275
N93HTW2BL	Tablet Left Arm, Veneer Back		6406	6597	6746	6910	7087	7279	7428	7620	7818
			8003	8308	8919	9295	9494	9700	9892	10090	10275
N93HTW2BB	Tablet Both Arms, Veneer Back		6658	6849	6998	7162	7339	7531	7680	7872	8070
			8255	8560	9171	9547	9746	9952	10144	10342	10527
N93HTW2BM	Mid Arms, Veneer Back		6598	6859	7063	7286	7529	7791	7994	8256	8528
			8780	9197	10031	10545	10817	11098	11360	11632	11884
N93HTW2BH	High Arms, Veneer Back		6670	6942	7154	7387	7639	7912	8124	8397	8679
			8942	9376	10245	10780	11063	11356	11629	11911	12174

DIMENSIONS

Width	47½	Seat Height	18½	Arm Height	27½	Weight	215
Width with Arms	55½	Seat Depth	20½	Mid Arm Height	40½	Weight with Arms	253
Depth	39	Seat Width	47½	High Arm Height	53½	Weight with Tablet	259
Height	53¼			Back Height	35½	Weight with 2 Tablets	264
				Back Width	47½	Weight with Mid Arms	269
						Weight with High Arms	285
						Cubic Ft.	51.3
						Cubic Ft. with Arms	58.3
						Cubic Ft. with Tablet	64.4
						Cubic Ft. with 2 Tablets	66.5

- Power grommet only available on arm models (factory installed); specify grommet option
- Power unavailable on front on bistro model seats due to built-in counterweight that ensures the stability of the unit
- Contrasting fabric option – specify X (i.e., N93HTU2MX); see page 231. For list pricing, use your electronic specification tool or contact customer service
- Add 28.75 lbs. for laminate and veneer back models
- Some assembly required
- Accepts laminate and veneer divider panels (page 226)
- Laminate and veneer divider panels can be added to an armless unit, onto the arm of a unit, or replace an existing arm
- Laminate and veneer divider panels cannot be added onto a tablet arm due to interference
- Accepts laminate and veneer back panels (page 227) which will be the height and width of a high back armless model

TO ORDER, SPECIFY:



- 1. Model Number
- 2. Fabric Grade / Cover Number
- 3. Power Grommet - Front of Arm
- 4. Power Grommet - Back of Arm
- 5. Bistro Table Finish
- 6. Tablet and Finish (when applicable)
- 7. Finish/Laminate
- 8. Metal Bracket Color
- 9. Leg Color
- 10. Glides

- See pages 229-230 for Fringe options
- See pages 264-278 for COM fabric yardage

**BISTRO TABLE
HIGH BACK
2 SEAT LOUNGE
SINGLE ARM**

**MODEL
NO.**

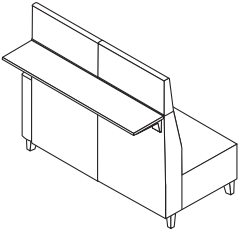
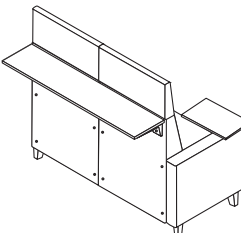
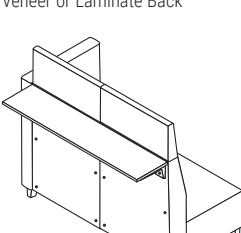
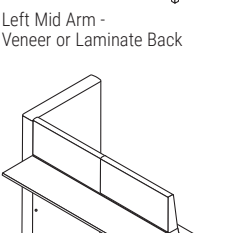
ALLIANCE PROGRAM PRICE GRADES

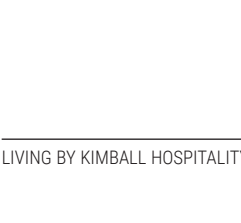
		A	B	C	D	E	F	G	H	I	
		J	K	L	M	N	O	P	Q	R	
UPHOLSTERED BACK											
	N93HTU2R	Right Arm, Upholstered Back	\$ 4984	5164	5305	5459	5627	5808	5948	6129	6317
			6491	6779	7355	7710	7898	8092	8273	8461	8635
	N93HTU2RR	Tablet Right Arm, Upholstered Back	5238	5418	5559	5713	5881	6062	6202	6383	6571
			6745	7033	7609	7964	8152	8346	8527	8715	8889
	N93HTU2RM	Right Mid Arms, Upholstered Back	5177	5377	5532	5702	5887	6087	6243	6442	6650
			6842	7160	7797	8189	8396	8611	8810	9018	9210
	N93HTU2RH	Right High Arms, Upholstered Back	5237	5455	5625	5812	6014	6233	6403	6622	6848
			7059	7407	8104	8533	8760	8995	9214	9440	9651
	N93HTU2L	Left Arm, Upholstered Back	4984	5164	5305	5459	5627	5808	5948	6129	6317
			6491	6779	7355	7710	7898	8092	8273	8461	8635
	N93HTU2LL	Tablet Left Arm, Upholstered Back	5238	5418	5559	5713	5881	6062	6202	6383	6571
			6745	7033	7609	7964	8152	8346	8527	8715	8889
	N93HTU2LM	Left Mid Arms, Upholstered Back	5177	5377	5532	5702	5887	6087	6243	6442	6650
			6842	7160	7797	8189	8396	8611	8810	9018	9210
	N93HTU2LH	Left High Arms, Upholstered Back	5237	5455	5625	5812	6014	6233	6403	6622	6848
			7059	7407	8104	8533	8760	8995	9214	9440	9651

Left Arm - Upholstered Back

Tablet Right Arm -
Veneer or Laminate Back

Left Mid Arm -
Veneer or Laminate Back

Left High Arm -
Veneer or Laminate Back

DIMENSIONS

Width	51½	Seat Height	18½	Arm Height	27½	Weight	234
Depth	39	Seat Depth	20½	Mid Arm Height	40%	Weight with Tablet	240
Height	53¼	Seat Width	47½	High Arm Height	53¼	Weight with Mid Arms	242
				Back Height	35¼	Weight with High Arms	250
				Back Width	47½	Cubic Ft.	54.8
						Cubic Ft. with Tablet	60.6

- Power grommet only available on arm models (factory installed); specify grommet option
- Power unavailable on front on bistro model seats due to built-in counterweight that ensures the stability of the unit
- Contrasting fabric option – specify X (i.e., N93HTU2RX); see page 231. For list pricing, use your electronic specification tool or contact customer service
- Add 28.75 lbs. for laminate and veneer back models
- Some assembly required
- Accepts laminate and veneer divider panels (page 226)
- Laminate and veneer divider panels can be added to an armless unit, onto the arm of a unit, or replace an existing arm
- Laminate and veneer divider panels cannot be added onto a tablet arm due to interference
- Accepts laminate and veneer back panels (page 227) which will be the height and width of a high back armless model

FRINGE

TO ORDER, SPECIFY:

1. Model Number
2. Fabric Grade / Cover Number
3. Power Grommet - Front of Arm
4. Power Grommet - Back of Arm
5. Bistro Table Finish
6. Tablet and Finish (when applicable)
7. Finish/Laminate
8. Metal Bracket Color
9. Leg Color
10. Glides

- See pages 229-230 for Fringe options
- See pages 264-278 for COM fabric yardage

BISTRO TABLE HIGH BACK 2 SEAT LOUNGE SINGLE ARM (CONTINUED)

MODEL NO.

ALLIANCE PROGRAM PRICE GRADES

	A	B	C	D	E	F	G	H	I
	J	K	L	M	N	O	P	Q	R

LAMINATE BACK

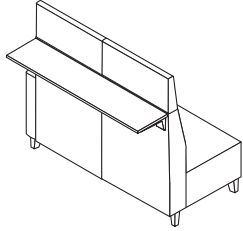

Left Arm - Upholstered Back

N93HTL2R	Right Arm, Laminate Back	\$ 5846	6005	6129	6264	6412	6571	6695	6854	7020
		7173	7427	7934	8247	8412	8583	8742	8908	9061
N93HTL2RR	Tablet Right Arm, Laminate Back	6099	6258	6382	6517	6665	6824	6948	7107	7273
		7426	7680	8187	8500	8665	8836	8995	9161	9314
N93HTL2RM	Right Mid Arms, Laminate Back	6037	6212	6349	6498	6661	6836	6973	7148	7330
		7499	7779	8338	8682	8864	9053	9228	9410	9579
N93HTL2RH	Right High Arms, Laminate Back	6100	6297	6450	6618	6800	6997	7151	7348	7552
		7742	8056	8684	9071	9275	9487	9684	9888	10078
N93HTL2L	Left Arm, Laminate Back	5846	6005	6129	6264	6412	6571	6695	6854	7020
		7173	7427	7934	8247	8412	8583	8742	8908	9061
N93HTL2LL	Tablet Left Arm, Laminate Back	6099	6258	6382	6517	6665	6824	6948	7107	7273
		7426	7680	8187	8500	8665	8836	8995	9161	9314
N93HTL2LM	Left Mid Arms, Laminate Back	6037	6212	6349	6498	6661	6836	6973	7148	7330
		7499	7779	8338	8682	8864	9053	9228	9410	9579
N93HTL2LH	Left High Arms, Laminate Back	6100	6297	6450	6618	6800	6997	7151	7348	7552
		7742	8056	8684	9071	9275	9487	9684	9888	10078

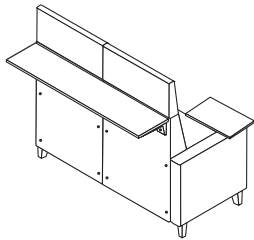

Tablet Right Arm - Veneer or Laminate Back

VENEER BACK

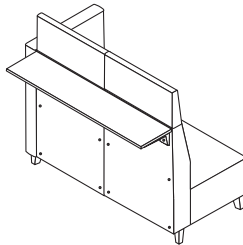

Left Mid Arm - Veneer or Laminate Back

N93HTW2R	Right Arm, Veneer Back	\$ 5846	6005	6129	6264	6412	6571	6695	6854	7020
		7173	7427	7934	8247	8412	8583	8742	8908	9061
N93HTW2RR	Tablet Right Arm, Veneer Back	6099	6258	6382	6517	6665	6824	6948	7107	7273
		7426	7680	8187	8500	8665	8836	8995	9161	9314
N93HTW2RM	Right Mid Arms, Veneer Back	6037	6212	6349	6498	6661	6836	6973	7148	7330
		7499	7779	8338	8682	8864	9053	9228	9410	9579
N93HTW2RH	Right High Arms, Veneer Back	6100	6297	6450	6618	6800	6997	7151	7348	7552
		7742	8056	8684	9071	9275	9487	9684	9888	10078
N93HTW2L	Left Arm, Veneer Back	5846	6005	6129	6264	6412	6571	6695	6854	7020
		7173	7427	7934	8247	8412	8583	8742	8908	9061
N93HTW2LL	Tablet Left Arm, Veneer Back	6099	6258	6382	6517	6665	6824	6948	7107	7273
		7426	7680	8187	8500	8665	8836	8995	9161	9314
N93HTW2LM	Left Mid Arms, Veneer Back	6037	6212	6349	6498	6661	6836	6973	7148	7330
		7499	7779	8338	8682	8864	9053	9228	9410	9579
N93HTW2LH	Left High Arms, Veneer Back	6100	6297	6450	6618	6800	6997	7151	7348	7552
		7742	8056	8684	9071	9275	9487	9684	9888	10078

DIMENSIONS

Width	51½	Seat Height	18½	Arm Height	27½	Weight	234
Depth	39	Seat Depth	20½	Mid Arm Height	40½	Weight with Tablet	240
Height	53¼	Seat Width	47½	High Arm Height	53¼	Weight with Mid Arms	242
				Back Height	35¼	Weight with High Arms	250
				Back Width	47½	Cubic Ft.	54.8
						Cubic Ft. with Tablet	60.6

- Power grommet only available on arm models (factory installed); specify grommet option
- Power unavailable on front on bistro model seats due to built-in counterweight that ensures the stability of the unit
- Contrasting fabric option – specify X (i.e., N93HTU2RX); see page 231. For list pricing, use your electronic specification tool or contact customer service
- Add 28.75 lbs. for laminate and veneer back models
- Some assembly required
- Accepts laminate and veneer divider panels (page 226)
- Laminate and veneer divider panels can be added to an armless unit, onto the arm of a unit, or replace an existing arm
- Laminate and veneer divider panels cannot be added onto a tablet arm due to interference
- Accepts laminate and veneer back panels (page 227) which will be the height and width of a high back armless model

TO ORDER, SPECIFY:

1. Model Number
2. Fabric Grade / Cover Number
3. Power Grommet - Front of Arm
4. Power Grommet - Back of Arm
5. Bistro Table Finish
6. Tablet and Finish (when applicable)
7. Finish/Laminate
8. Metal Bracket Color
9. Leg Color
10. Glides

- See pages 229-230 for Fringe options
- See pages 264-278 for COM fabric yardage

**BISTRO TABLE
MID BACK
3 SEAT LOUNGE**

**MODEL
NO.**

ALLIANCE PROGRAM PRICE GRADES

A	B	C	D	E	F	G	H	I
J	K	L	M	N	O	P	Q	R

UPHOLSTERED BACK

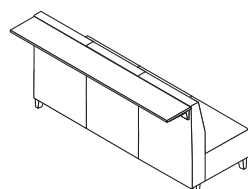

Armless - Upholstered Back

N93MTU3M	Armless, Upholstered Back	\$ 4784	4946	5072	5210	5360	5522	5648	5810	5978
		6134	6392	6908	7226	7394	7568	7730	7898	8054
N93MTU3B	Arms, Upholstered Back	5420	5660	5847	6051	6274	6514	6701	6941	7191
		7422	7805	8570	9042	9291	9549	9789	10039	10270
N93MTU3BR	Tablet Right Arm, Upholstered Back	5673	5913	6100	6304	6527	6767	6954	7194	7444
		7675	8058	8823	9295	9544	9802	10042	10292	10523
N93MTU3BL	Tablet Left Arm, Upholstered Back	5673	5913	6100	6304	6527	6767	6954	7194	7444
		7675	8058	8823	9295	9544	9802	10042	10292	10523
N93MTU3BB	Tablet Both Arms, Upholstered Back	5925	6165	6352	6556	6779	7019	7206	7446	7696
		7927	8310	9075	9547	9796	10054	10294	10544	10775
N93MTU3BM	Mid Arms, Upholstered Back	5815	6096	6314	6553	6813	7094	7313	7593	7885
		8155	8602	9497	10048	10339	10641	10921	11213	11483

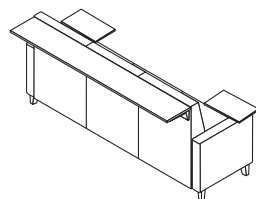

Tablet Right Arm - Upholstered Back

LAMINATE BACK

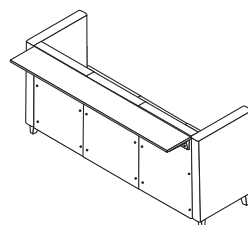

Mid Arms - Veneer or Laminate Back

N93MTL3M	Armless, Laminate Back	\$ 6073	6199	6298	6406	6524	6651	6749	6876	7008
		7130	7332	7736	7985	8117	8253	8380	8512	8634
N93MTL3B	Arms, Laminate Back	6703	6905	7063	7235	7423	7625	7783	7985	8195
		8390	8713	9358	9755	9965	10183	10385	10595	10790
N93MTL3BR	Tablet Right Arm, Laminate Back	6958	7160	7318	7490	7678	7880	8038	8240	8450
		8645	8968	9613	10010	10220	10438	10640	10850	11045
N93MTL3BL	Tablet Left Arm, Laminate Back	6958	7160	7318	7490	7678	7880	8038	8240	8450
		8645	8968	9613	10010	10220	10438	10640	10850	11045
N93MTL3BB	Tablet Both Arms, Laminate Back	7210	7412	7570	7742	7930	8132	8290	8492	8702
		8897	9220	9865	10262	10472	10690	10892	11102	11297
N93MTL3BM	Mid Arms, Laminate Back	7098	7341	7530	7737	7962	8205	8394	8637	8889
		9123	9510	10284	10761	11013	11274	11517	11769	12003

VENEER BACK

N93MTW3M	Armless, Veneer Back	\$ 6073	6199	6298	6406	6524	6651	6749	6876	7008
		7130	7332	7736	7985	8117	8253	8380	8512	8634
N93MTW3B	Arms, Veneer Back	6703	6905	7063	7235	7423	7625	7783	7985	8195
		8390	8713	9358	9755	9965	10183	10385	10595	10790
N93MTW3BR	Tablet Right Arm, Veneer Back	6958	7160	7318	7490	7678	7880	8038	8240	8450
		8645	8968	9613	10010	10220	10438	10640	10850	11045
N93MTW3BL	Tablet Left Arm, Veneer Back	6958	7160	7318	7490	7678	7880	8038	8240	8450
		8645	8968	9613	10010	10220	10438	10640	10850	11045
N93MTW3BB	Tablet Both Arms, Veneer Back	7210	7412	7570	7742	7930	8132	8290	8492	8702
		8897	9220	9865	10262	10472	10690	10892	11102	11297
N93MTW3BM	Mid Arms, Veneer Back	7098	7341	7530	7737	7962	8205	8394	8637	8889
		9123	9510	10284	10761	11013	11274	11517	11769	12003

DIMENSIONS

Width	70%	Seat Height	18½	Arm Height	27½	Weight	260
Width with Arms	78%	Seat Depth	20%	Mid Arm Height	40%	Weight with Arms	298
Depth	39	Seat Width	70%	Back Height	22½	Weight with Tablet	304
Height	40%			Back Width	70%	Weight with 2 Tablets	309
						Weight with Mid Arms	314
						Cubic Ft.	58.3
						Cubic Ft. with Arms	63.8
						Cubic Ft. with Tablet	69.8
						Cubic Ft. with 2 Tablets	71.5

- Power grommet only available on arm models (factory installed); specify grommet option
- Power unavailable on front on bistro model seats due to built-in counterweight that ensures the stability of the unit
- Contrasting fabric option – specify X (i.e., N93MTU3MX); see page 231. For list pricing, use your electronic specification tool or contact customer service
- Add 43 lbs. for laminate and veneer back models
- Some assembly required
- Accepts laminate and veneer divider panels (page 226)
- Laminate and veneer divider panels can be added to an armless unit, onto the arm of a unit, or replace an existing arm
- Laminate and veneer divider panels cannot be added onto a tablet arm due to interference
- Accepts laminate and veneer back panels (page 227) which will be the height and width of a high back armless model

FRINGE

TO ORDER, SPECIFY:

1. Model Number
2. Fabric Grade / Cover Number
3. Power Grommet - Front of Arm
4. Power Grommet - Back of Arm
5. Bistro Table Finish
6. Tablet and Finish (when applicable)
7. Finish/Laminate
8. Metal Bracket Color
9. Leg Color
10. Glides

- See pages 229-230 for Fringe options
- See pages 264-278 for COM fabric yardage

BISTRO TABLE MID BACK 3 SEAT LOUNGE SINGLE ARM

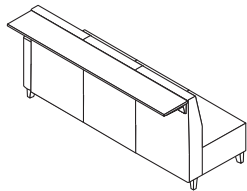

Left Arm - Upholstered Back

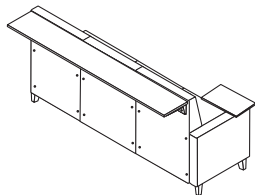

Tablet Right Arm -
Veneer or Laminate Back

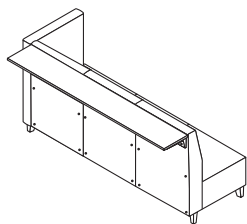

Left Mid Arm -
Veneer or Laminate Back

MODEL NO.

ALLIANCE PROGRAM PRICE GRADES

		A	B	C	D	E	F	G	H	I
		J	K	L	M	N	O	P	Q	R
UPHOLSTERED BACK										
N93MTU3R	Right Arm, Upholstered Back	\$ 5107	5312	5472	5647	5837	6042	6201	6407	6619
		6817	7144	7797	8200	8413	8633	8839	9051	9249
N93MTU3RR	Tablet Right Arm, Upholstered Back	5361	5566	5726	5901	6091	6296	6455	6661	6873
		7071	7398	8051	8454	8667	8887	9093	9305	9503
N93MTU3RM	Right Mid Arms, Upholstered Back	5304	5528	5702	5893	6100	6324	6499	6723	6955
		7171	7528	8242	8682	8914	9155	9379	9611	9827
N93MTU3L	Left Arm, Upholstered Back	5107	5312	5472	5647	5837	6042	6201	6407	6619
		6817	7144	7797	8200	8413	8633	8839	9051	9249
N93MTU3LL	Tablet Left Arm, Upholstered Back	5361	5566	5726	5901	6091	6296	6455	6661	6873
		7071	7398	8051	8454	8667	8887	9093	9305	9503
N93MTU3LM	Left Mid Arms, Upholstered Back	5304	5528	5702	5893	6100	6324	6499	6723	6955
		7171	7528	8242	8682	8914	9155	9379	9611	9827
LAMINATE BACK										
N93MTL3R	Right Arm, Laminate Back	\$ 6392	6559	6690	6832	6987	7155	7285	7452	7626
		7787	8054	8587	8915	9089	9269	9436	9610	9771
N93MTL3RR	Tablet Right Arm, Laminate Back	6644	6811	6942	7084	7239	7407	7537	7704	7878
		8039	8306	8839	9167	9341	9521	9688	9862	10023
N93MTL3RM	Right Mid Arms, Laminate Back	6588	6774	6919	7077	7250	7436	7581	7767	7961
		8140	8437	9030	9396	9589	9789	9975	10169	10348
N93MTL3L	Left Arm, Laminate Back	6392	6559	6690	6832	6987	7155	7285	7452	7626
		7787	8054	8587	8915	9089	9269	9436	9610	9771
N93MTL3LL	Tablet Left Arm, Laminate Back	6644	6811	6942	7084	7239	7407	7537	7704	7878
		8039	8306	8839	9167	9341	9521	9688	9862	10023
N93MTL3LM	Left Mid Arms, Laminate Back	6588	6774	6919	7077	7250	7436	7581	7767	7961
		8140	8437	9030	9396	9589	9789	9975	10169	10348
VENEER BACK										
N93MTW3R	Right Arm, Veneer Back	\$ 6392	6559	6690	6832	6987	7155	7285	7452	7626
		7787	8054	8587	8915	9089	9269	9436	9610	9771
N93MTW3RR	Tablet Right Arm, Veneer Back	6644	6811	6942	7084	7239	7407	7537	7704	7878
		8039	8306	8839	9167	9341	9521	9688	9862	10023
N93MTW3RM	Right Mid Arms, Veneer Back	6588	6774	6919	7077	7250	7436	7581	7767	7961
		8140	8437	9030	9396	9589	9789	9975	10169	10348
N93MTW3L	Left Arm, Veneer Back	6392	6559	6690	6832	6987	7155	7285	7452	7626
		7787	8054	8587	8915	9089	9269	9436	9610	9771
N93MTW3LL	Tablet Left Arm, Veneer Back	6644	6811	6942	7084	7239	7407	7537	7704	7878
		8039	8306	8839	9167	9341	9521	9688	9862	10023
N93MTW3LM	Left Mid Arms, Veneer Back	6588	6774	6919	7077	7250	7436	7581	7767	7961
		8140	8437	9030	9396	9589	9789	9975	10169	10348

DIMENSIONS

Width	74%	Seat Height	18½	Arm Height	27½	Weight	279
Depth	39	Seat Depth	20½	Mid Arm Height	40%	Weight with Tablet	285
Height	40%	Seat Width	70%	Back Height	22½	Weight with Mid Arms	287
				Back Width	70%	Cubic Ft.	61.1
						Cubic Ft. with Tablet	66.8

- Power grommet only available on arm models (factory installed); specify grommet option
- Power unavailable on front on bistro model seats due to built-in counterweight that ensures the stability of the unit
- Contrasting fabric option – specify X (i.e., N93MTU3RX); see page 231. For list pricing, use your electronic specification tool or contact customer service
- Add 43 lbs. for laminate and veneer back models
- Some assembly required
- Accepts laminate and veneer divider panels (page 226)
- Laminate and veneer divider panels can be added to an armless unit, onto the arm of a unit, or replace an existing arm
- Laminate and veneer divider panels cannot be added onto a tablet arm due to interference
- Accepts laminate and veneer back panels (page 227) which will be the height and width of a high back armless model

TO ORDER, SPECIFY:

- 1. Model Number
- 2. Fabric Grade / Cover Number
- 3. Power Grommet - Front of Arm
- 4. Power Grommet - Back of Arm
- 5. Bistro Table Finish
- 6. Tablet and Finish (when applicable)
- 7. Finish/Laminate
- 8. Metal Bracket Color
- 9. Leg Color
- 10. Glides

- See pages 229-230 for Fringe options
- See pages 264-278 for COM fabric yardage

**BISTRO TABLE
HIGH BACK
3 SEAT LOUNGE**

**MODEL
NO.**

ALLIANCE PROGRAM PRICE GRADES

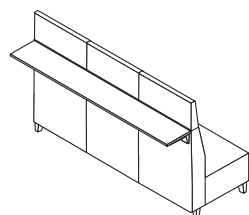

Armless - Upholstered Back

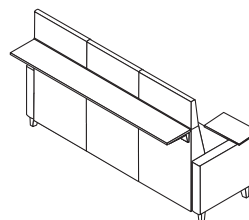

Tablet Right Arm - Upholstered Back

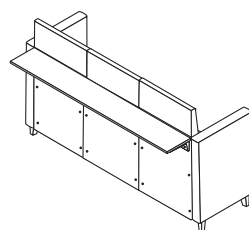

Mid Arms - Veneer or Laminate Back

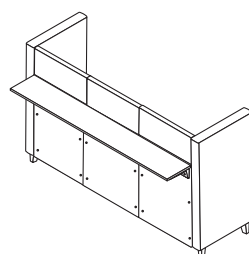

High Arms - Veneer or Laminate Back

UPHOLSTERED BACK

		A	B	C	D	E	F	G	H	I
		J	K	L	M	N	O	P	Q	R
N93HTU3M	Armless, Upholstered Back	\$ 5957	6148	6297	6461	6638	6830	6979	7171	7369
		7554	7859	8470	8846	9045	9251	9443	9641	9826
N93HTU3B	Arms, Upholstered Back	6587	6854	7062	7289	7537	7804	8012	8279	8557
		8814	9240	10091	10616	10893	11180	11447	11725	11982
N93HTU3BR	Tablet Right Arm, Upholstered Back	6840	7107	7315	7542	7790	8057	8265	8532	8810
		9067	9493	10344	10869	11146	11433	11700	11978	12235
N93HTU3BL	Tablet Left Arm, Upholstered Back	6840	7107	7315	7542	7790	8057	8265	8532	8810
		9067	9493	10344	10869	11146	11433	11700	11978	12235
N93HTU3BB	Tablet Both Arms, Upholstered Back	7094	7361	7569	7796	8044	8311	8519	8786	9064
		9321	9747	10598	11123	11400	11687	11954	12232	12489
N93HTU3BM	Mid Arms, Upholstered Back	6986	7296	7538	7802	8090	8400	8642	8952	9274
		9573	10068	11057	11666	11988	12322	12632	12954	13253
N93HTU3BH	High Arms, Upholstered Back	7105	7453	7724	8020	8343	8691	8962	9310	9672
		10007	10562	11671	12355	12716	13090	13438	13800	14135

DIMENSIONS

Width	70¾	Seat Height	18½	Arm Height	27½	Weight	300
Width with Arms	78¾	Seat Depth	20½	Mid Arm Height	40¾	Weight with Arms	338
Depth	39	Seat Width	70¾	High Arm Height	53¾	Weight with Tablet	345
Height	53¾			Back Height	35¾	Weight with 2 Tablets	350
				Back Width	70¾	Weight with Mid Arms	354
						Weight with High Arms	370
						Cubic Ft.	74.3
						Cubic Ft. with Arms	81.4
						Cubic Ft. with Tablet	88.9
						Cubic Ft. with 2 Tablets	91.1

- Power grommet only available on arm models (factory installed); specify grommet option
- Power unavailable on front on bistro model seats due to built-in counterweight that ensures the stability of the unit
- Contrasting fabric option – specify X (i.e., N93HTU3MX); see page 231. For list pricing, use your electronic specification tool or contact customer service
- Add 43 lbs. for laminate and veneer back models
- Some assembly required
- Accepts laminate and veneer divider panels (page 226)
- Laminate and veneer divider panels can be added to an armless unit, onto the arm of a unit, or replace an existing arm
- Laminate and veneer divider panels cannot be added onto a tablet arm due to interference
- Accepts laminate and veneer back panels (page 227) which will be the height and width of a high back armless model

FRINGE

TO ORDER, SPECIFY:

1. Model Number
2. Fabric Grade / Cover Number
3. Power Grommet - Front of Arm
4. Power Grommet - Back of Arm
5. Bistro Table Finish
6. Tablet and Finish (when applicable)
7. Finish/Laminate
8. Metal Bracket Color
9. Leg Color
10. Glides

- See pages 229-230 for Fringe options
- See pages 264-278 for COM fabric yardage

BISTRO TABLE HIGH BACK 3 SEAT LOUNGE (CONTINUED)

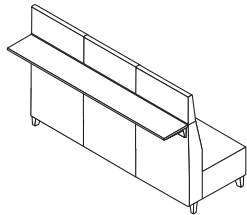

Armless - Upholstered Back

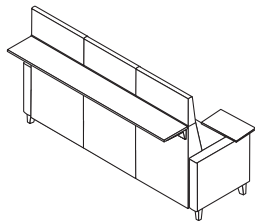

Tablet Right Arm - Upholstered Back

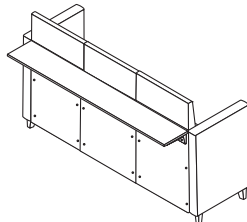

Mid Arms - Veneer or Laminate Back

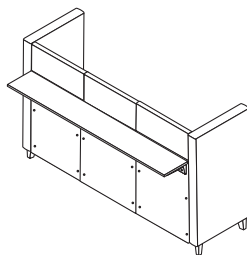

High Arms - Veneer or Laminate Back

MODEL NO.

ALLIANCE PROGRAM PRICE GRADES

			A	B	C	D	E	F	G	H	I
			J	K	L	M	N	O	P	Q	R
LAMINATE BACK											
N93HTL3M	Armless, Laminate Back	\$	7245	7402	7523	7657	7802	7958	8080	8237	8399
			8550	8799	9298	9606	9768	9936	10093	10255	10406
N93HTL3B	Arms, Laminate Back		7876	8108	8289	8487	8702	8934	9114	9347	9587
			9811	10181	10920	11376	11617	11866	12099	12339	12563
N93HTL3BR	Tablet Right Arm, Laminate Back		8128	8360	8541	8739	8954	9186	9366	9599	9839
			10063	10433	11172	11628	11869	12118	12351	12591	12815
N93HTL3BL	Tablet Left Arm, Laminate Back		8128	8360	8541	8739	8954	9186	9366	9599	9839
			10063	10433	11172	11628	11869	12118	12351	12591	12815
N93HTL3BB	Tablet Both Arms, Laminate Back		8383	8615	8796	8994	9209	9441	9621	9854	10094
			10318	10688	11427	11883	12124	12373	12606	12846	13070
N93HTL3BM	Mid Arms, Laminate Back		8276	8551	8766	9000	9255	9531	9745	10020	10306
			10571	11010	11887	12427	12713	13009	13284	13570	13835
N93HTL3BH	High Arms, Laminate Back		8393	8706	8950	9217	9507	9820	10063	10377	10701
			11003	11502	12499	13114	13439	13775	14089	14413	14715

VENEER BACK

N93HTW3M	Armless, Veneer Back	\$	7245	7402	7523	7657	7802	7958	8080	8237	8399
			8550	8799	9298	9606	9768	9936	10093	10255	10406
N93HTW3B	Arms, Veneer Back		7876	8108	8289	8487	8702	8934	9114	9347	9587
			9811	10181	10920	11376	11617	11866	12099	12339	12563
N93HTW3BR	Tablet Right Arm, Veneer Back		8128	8360	8541	8739	8954	9186	9366	9599	9839
			10063	10433	11172	11628	11869	12118	12351	12591	12815
N93HTW3BL	Tablet Left Arm, Veneer Back		8128	8360	8541	8739	8954	9186	9366	9599	9839
			10063	10433	11172	11628	11869	12118	12351	12591	12815
N93HTW3BB	Tablet Both Arms, Veneer Back		8383	8615	8796	8994	9209	9441	9621	9854	10094
			10318	10688	11427	11883	12124	12373	12606	12846	13070
N93HTW3BM	Mid Arms, Veneer Back		8276	8551	8766	9000	9255	9531	9745	10020	10306
			10571	11010	11887	12427	12713	13009	13284	13570	13835
N93HTW3BH	High Arms, Veneer Back		8393	8706	8950	9217	9507	9820	10063	10377	10701
			11003	11502	12499	13114	13439	13775	14089	14413	14715

DIMENSIONS

Width	70%	Seat Height	18%	Arm Height	27%	Weight	300
Width with Arms	78%	Seat Depth	20%	Mid Arm Height	40%	Weight with Arms	338
Depth	39	Seat Width	70%	High Arm Height	53%	Weight with Tablet	345
Height	53%			Back Height	35%	Weight with 2 Tablets	350
				Back Width	70%	Weight with Mid Arms	354
						Weight with High Arms	370
						Cubic Ft.	74.3
						Cubic Ft. with Arms	81.4
						Cubic Ft. with Tablet	88.9
						Cubic Ft. with 2 Tablets	91.1

- Power grommet only available on arm models (factory installed); specify grommet option
- Power unavailable on front on bistro model seats due to built-in counterweight that ensures the stability of the unit
- Contrasting fabric option – specify X (i.e., N93HTU3MX); see page 231. For list pricing, use your electronic specification tool or contact customer service
- Add 43 lbs. for laminate and veneer back models
- Some assembly required
- Accepts laminate and veneer divider panels (page 226)
- Laminate and veneer divider panels can be added to an armless unit, onto the arm of a unit, or replace an existing arm
- Laminate and veneer divider panels cannot be added onto a tablet arm due to interference
- Accepts laminate and veneer back panels (page 227) which will be the height and width of a high back armless model

TO ORDER, SPECIFY:

- 1. Model Number
- 2. Fabric Grade / Cover Number
- 3. Power Grommet - Front of Arm
- 4. Power Grommet - Back of Arm
- 5. Bistro Table Finish
- 6. Tablet and Finish (when applicable)
- 7. Finish/Laminate
- 8. Metal Bracket Color
- 9. Leg Color
- 10. Glides

- See pages 229-230 for Fringe options
- See pages 264-278 for COM fabric yardage

**BISTRO TABLE
HIGH BACK
3 SEAT LOUNGE
SINGLE ARM**

**MODEL
NO.**

ALLIANCE PROGRAM PRICE GRADES

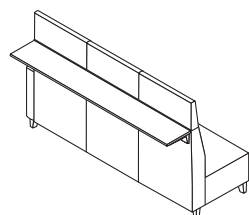

Left Arm - Upholstered Back

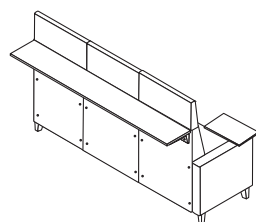

Tablet Right Arm -
Veneer or Laminate Back

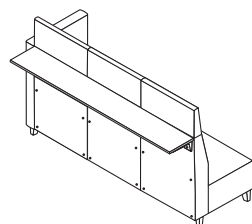

Left Mid Arm -
Veneer or Laminate Back

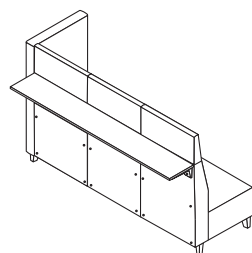

Left High Arm -
Veneer or Laminate Back

UPHOLSTERED BACK

			A	B	C	D	E	F	G	H	I
			J	K	L	M	N	O	P	Q	R
N93HTU3R	Right Arm, Upholstered Back	\$	6280	6514	6697	6897	7115	7350	7532	7767	8011
			8237	8611	9359	9820	10064	10316	10551	10795	11021
N93HTU3RR	Tablet Right Arm, Upholstered Back		6533	6767	6950	7150	7368	7603	7785	8020	8264
			8490	8864	9612	10073	10317	10569	10804	11048	11274
N93HTU3RM	Right Mid Arms, Upholstered Back		6476	6730	6927	7143	7378	7632	7830	8083	8347
			8591	8995	9804	10302	10565	10838	11091	11355	11599
N93HTU3RH	Right High Arms, Upholstered Back		6534	6806	7018	7251	7503	7776	7988	8261	8543
			8806	9240	10109	10644	10927	11220	11493	11775	12038
N93HTU3L	Left Arm, Upholstered Back		6280	6514	6697	6897	7115	7350	7532	7767	8011
			8237	8611	9359	9820	10064	10316	10551	10795	11021
N93HTU3LL	Tablet Left Arm, Upholstered Back		6533	6767	6950	7150	7368	7603	7785	8020	8264
			8490	8864	9612	10073	10317	10569	10804	11048	11274
N93HTU3LM	Left Mid Arms, Upholstered Back		6476	6730	6927	7143	7378	7632	7830	8083	8347
			8591	8995	9804	10302	10565	10838	11091	11355	11599
N93HTU3LH	Left High Arms, Upholstered Back		6534	6806	7018	7251	7503	7776	7988	8261	8543
			8806	9240	10109	10644	10927	11220	11493	11775	12038

DIMENSIONS

Width	74¾	Seat Height	18½	Arm Height	27½	Weight	319
Depth	39	Seat Depth	20½	Mid Arm Height	40%	Weight with Tablet	326
Height	53¾	Seat Width	70%	High Arm Height	53¾	Weight with Mid Arms	327
				Back Height	35%	Weight with High Arms	335
				Back Width	70%	Cubic Ft.	77.8
						Cubic Ft. with Tablet	85.2

- Power grommet only available on arm models (factory installed); specify grommet option
- Power unavailable on front on bistro model seats due to built-in counterweight that ensures the stability of the unit
- Contrasting fabric option – specify X (i.e., N93HTU3RX); see page 231. For list pricing, use your electronic specification tool or contact customer service
- Add 43 lbs. for laminate and veneer back models
- Some assembly required
- Accepts laminate and veneer divider panels (page 226)
- Laminate and veneer divider panels can be added to an armless unit, onto the arm of a unit, or replace an existing arm
- Laminate and veneer divider panels cannot be added onto a tablet arm due to interference
- Accepts laminate and veneer back panels (page 227) which will be the height and width of a high back armless model

FRINGE

TO ORDER, SPECIFY:

1. Model Number
2. Fabric Grade / Cover Number
3. Power Grommet - Front of Arm
4. Power Grommet - Back of Arm
5. Bistro Table Finish
6. Tablet and Finish (when applicable)
7. Finish/Laminate
8. Metal Bracket Color
9. Leg Color
10. Glides

- See pages 229-230 for Fringe options
- See pages 264-278 for COM fabric yardage

BISTRO TABLE HIGH BACK 3 SEAT LOUNGE SINGLE ARM (CONTINUED)

MODEL NO.

ALLIANCE PROGRAM PRICE GRADES

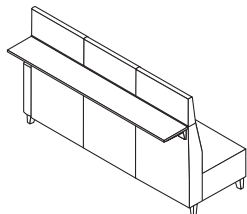

Left Arm - Upholstered Back

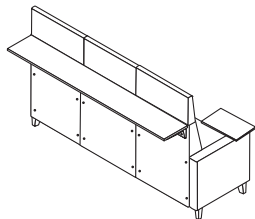

Tablet Right Arm - Veneer or Laminate Back

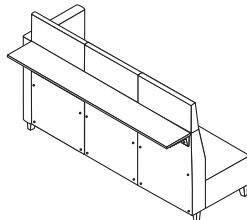

Left Mid Arm - Veneer or Laminate Back

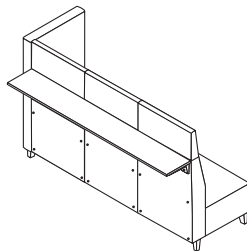

Left High Arm - Veneer or Laminate Back

	A	B	C	D	E	F	G	H	I
	J	K	L	M	N	O	P	Q	R

LAMINATE BACK

N93HTL3R	Right Arm, Laminate Back	\$ 7569	7769	7924	8094	8279	8479	8635	8834	9042
		9234	9552	10189	10581	10788	11003	11202	11410	11602
N93HTL3RR	Tablet Right Arm, Laminate Back	7822	8022	8177	8347	8532	8732	8888	9087	9295
		9487	9805	10442	10834	11041	11256	11455	11663	11855
N93HTL3RM	Right Mid Arms, Laminate Back	7761	7977	8145	8329	8529	8745	8913	9129	9353
		9561	9905	10593	11017	11241	11473	11689	11913	12121
N93HTL3RH	Right High Arms, Laminate Back	7824	8062	8246	8449	8669	8906	9091	9329	9575
		9804	10182	10939	11406	11652	11907	12145	12391	12620
N93HTL3L	Left Arm, Laminate Back	7569	7769	7924	8094	8279	8479	8635	8834	9042
		9234	9552	10189	10581	10788	11003	11202	11410	11602
N93HTL3LL	Tablet Left Arm, Laminate Back	7822	8022	8177	8347	8532	8732	8888	9087	9295
		9487	9805	10442	10834	11041	11256	11455	11663	11855
N93HTL3LM	Left Mid Arms, Laminate Back	7761	7977	8145	8329	8529	8745	8913	9129	9353
		9561	9905	10593	11017	11241	11473	11689	11913	12121
N93HTL3LH	Left High Arms, Laminate Back	7824	8062	8246	8449	8669	8906	9091	9329	9575
		9804	10182	10939	11406	11652	11907	12145	12391	12620

VENEER BACK

N93HTW3R	Right Arm, Veneer Back	\$ 7569	7769	7924	8094	8279	8479	8635	8834	9042
		9234	9552	10189	10581	10788	11003	11202	11410	11602
N93HTW3RR	Tablet Right Arm, Veneer Back	7822	8022	8177	8347	8532	8732	8888	9087	9295
		9487	9805	10442	10834	11041	11256	11455	11663	11855
N93HTW3RM	Right Mid Arms, Veneer Back	7761	7977	8145	8329	8529	8745	8913	9129	9353
		9561	9905	10593	11017	11241	11473	11689	11913	12121
N93HTW3RH	Right High Arms, Veneer Back	7824	8062	8246	8449	8669	8906	9091	9329	9575
		9804	10182	10939	11406	11652	11907	12145	12391	12620
N93HTW3L	Left Arm, Veneer Back	7569	7769	7924	8094	8279	8479	8635	8834	9042
		9234	9552	10189	10581	10788	11003	11202	11410	11602
N93HTW3LL	Tablet Left Arm, Veneer Back	7822	8022	8177	8347	8532	8732	8888	9087	9295
		9487	9805	10442	10834	11041	11256	11455	11663	11855
N93HTW3LM	Left Mid Arms, Veneer Back	7761	7977	8145	8329	8529	8745	8913	9129	9353
		9561	9905	10593	11017	11241	11473	11689	11913	12121
N93HTW3LH	Left High Arms, Veneer Back	7824	8062	8246	8449	8669	8906	9091	9329	9575
		9804	10182	10939	11406	11652	11907	12145	12391	12620

DIMENSIONS

Width	74%	Seat Height	18½	Arm Height	27½	Weight	319
Depth	39	Seat Depth	20½	Mid Arm Height	40%	Weight with Tablet	326
Height	53%	Seat Width	70%	High Arm Height	53%	Weight with Mid Arms	327
				Back Height	35%	Weight with High Arms	335
				Back Width	70%	Cubic Ft.	77.8
						Cubic Ft. with Tablet	85.2

- Power grommet only available on arm models (factory installed); specify grommet option
- Power unavailable on front on bistro model seats due to built-in counterweight that ensures the stability of the unit
- Contrasting fabric option – specify X (i.e., N93HTU3RX); see page 231. For list pricing, use your electronic specification tool or contact customer service
- Add 43 lbs. for laminate and veneer back models
- Some assembly required
- Accepts laminate and veneer divider panels (page 226)
- Laminate and veneer divider panels can be added to an armless unit, onto the arm of a unit, or replace an existing arm
- Laminate and veneer divider panels cannot be added onto a tablet arm due to interference
- Accepts laminate and veneer back panels (page 227) which will be the height and width of a high back armless model

TO ORDER, SPECIFY:

1. Model Number
2. Fabric Grade / Cover Number
3. Bistro Table Finish
4. Finish/Laminate (when applicable)
5. Metal Bracket Color
6. Leg Color
7. Glides

- See pages 229-230 for Fringe options
- See pages 264-278 for COM fabric yardage

**BISTRO TABLE
MID BACK
2 SEAT COVE**

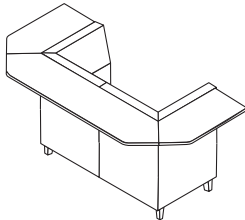

Upholstered Back

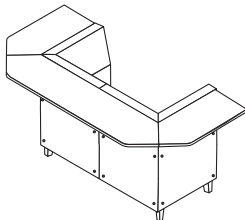

Veneer or Laminate Back

**MODEL
NO.**

ALLIANCE PROGRAM PRICE GRADES

			A	B	C	D	E	F	G	H	I
			J	K	L	M	N	O	P	Q	R
N93MTUC2	Upholstered Back	\$	5553	5747	5899	6064	6244	6439	6590	6784	6986
			7173	7483	8102	8483	8685	8894	9088	9290	9477
N93MTLC2	Laminate Back		6413	6572	6696	6831	6979	7138	7262	7421	7587
			7740	7994	8501	8814	8979	9150	9309	9475	9628
N93MTWC2	Veneer Back		6413	6572	6696	6831	6979	7138	7262	7421	7587
			7740	7994	8501	8814	8979	9150	9309	9475	9628

DIMENSIONS

Width	53¼	Seat Height	18½	Back Height	22½	Weight	184
Depth	27	Seat Depth	20½	Back Width	53½	Cubic Ft.	45.0
Height	40¼	Seat Width	53½				

- Contrasting fabric option – specify X (i.e., N93MTUC2X); see page 231. For list pricing, use your electronic specification tool or contact customer service
- Power grommet option not available

**BISTRO TABLE
HIGH BACK
2 SEAT COVE**

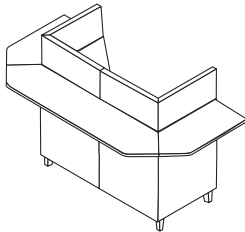

Upholstered Back

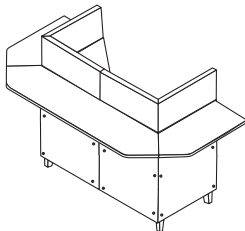

Veneer or Laminate Back

			A	B	C	D	E	F	G	H	I
			J	K	L	M	N	O	P	Q	R
N93HTUC2	Upholstered Back	\$	7346	7605	7807	8028	8268	8527	8728	8988	9256
			9506	9919	10744	11253	11522	11800	12060	12328	12578
N93HTLC2	Laminate Back		8179	8386	8548	8725	8918	9126	9287	9495	9711
			9911	10242	10904	11312	11528	11751	11959	12175	12375
N93HTWC2	Veneer Back		8179	8386	8548	8725	8918	9126	9287	9495	9711
			9911	10242	10904	11312	11528	11751	11959	12175	12375

DIMENSIONS

Width	53¼	Seat Height	18½	Back Height	35¼	Weight	238
Depth	27	Seat Depth	20½	Back Width	53½	Cubic Ft.	57.3
Height	53¼	Seat Width	53½				

- Contrasting fabric option – specify X (i.e., N93HTUC2X); see page 231. For list pricing, use your electronic specification tool or contact customer service
- Power grommet option not available

FRINGE

TO ORDER, SPECIFY:

1. Model Number
2. Fabric Grade / Cover Number
3. Bistro Table Finish
4. Finish/Laminate (when applicable)
5. Metal Bracket Color
6. Leg Color
7. Glides

- See pages 229-230 for Fringe options
- See pages 264-278 for COM fabric yardage

BISTRO TABLE MID BACK 3 SEAT COVE

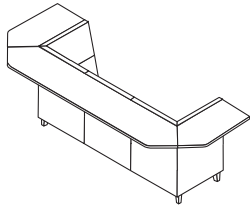

Upholstered Back

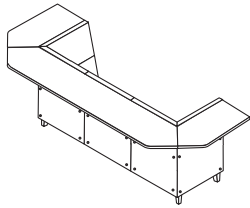

Veneer or Laminate Back

MODEL NO.

ALLIANCE PROGRAM PRICE GRADES

			A	B	C	D	E	F	G	H	I
			J	K	L	M	N	O	P	Q	R
N93MTUC3	Upholstered Back	\$	7018	7306	7531	7777	8045	8334	8558	8847	9147
			9425	9885	10805	11372	11672	11982	12271	12571	12849
N93MTLC3	Laminate Back		8231	8463	8644	8842	9057	9289	9469	9702	9942
			10166	10536	11275	11731	11972	12221	12454	12694	12918
N93MTWC3	Veneer Back		8231	8463	8644	8842	9057	9289	9469	9702	9942
			10166	10536	11275	11731	11972	12221	12454	12694	12918

DIMENSIONS

Width	77¼	Seat Height	18½	Back Height	22½	Weight	253
Depth	27	Seat Depth	20½	Back Width	76¼	Cubic Ft.	63.0
Height	40¼	Seat Depth	76¼				

- Contrasting fabric option – specify X (i.e., N93MTUC3X); see page 231. For list pricing, use your electronic specification tool or contact customer service
- Power grommet option not available

BISTRO TABLE HIGH BACK 3 SEAT COVE

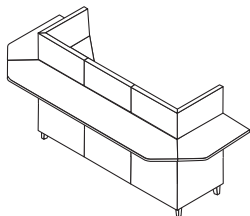

Upholstered Back

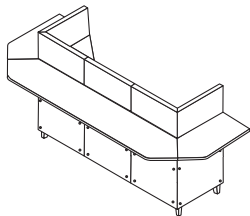

Veneer or Laminate Back

			A	B	C	D	E	F	G	H	I
			J	K	L	M	N	O	P	Q	R
N93HTUC3	Upholstered Back	\$	9291	9664	9953	10271	10616	10988	11278	11651	12037
			12396	12989	14176	14908	15294	15694	16067	16453	16812
N93HTLC3	Laminate Back		10482	10784	11020	11277	11557	11860	12095	12397	12711
			13002	13484	14447	15040	15354	15679	15981	16295	16586
N93HTWC3	Veneer Back		10482	10784	11020	11277	11557	11860	12095	12397	12711
			13002	13484	14447	15040	15354	15679	15981	16295	16586

DIMENSIONS

Width	77¼	Seat Height	18½	Back Height	35¼	Weight	321
Depth	27	Seat Depth	20½	Back Width	76¼	Cubic Ft.	80.4
Height	53¼	Seat Width	76¼				

- Contrasting fabric option – specify X (i.e., N93HTUC3X); see page 231. For list pricing, use your electronic specification tool or contact customer service
- Power grommet option not available

TO ORDER, SPECIFY:

1. Model Number
2. Fabric Grade / Cover Number
3. Bistro Table Finish
4. Finish/Laminate (when applicable)
5. Metal Bracket Color
6. Leg Color
7. Glides

- See pages 229-230 for Fringe options
- See pages 264-278 for COM fabric yardage

**BISTRO TABLE
MID BACK
SQUARE 90°
CORNER**

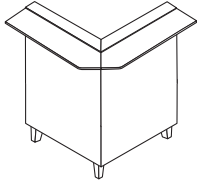

Upholstered Back

MODEL NO.

ALLIANCE PROGRAM PRICE GRADES

		A	B	C	D	E	F	G	H	I
		J	K	L	M	N	O	P	Q	R
UPHOLSTERED BACK										
N93MTUSQ9R	Square 90°, Upholstered Back, Right	\$ 3377	3490	3579	3675	3780	3894	3982	4095	4213
		4322	4503	4864	5086	5204	5326	5439	5557	5666
N93MTUSQ9L	Square 90°, Upholstered Back, Left	3377	3490	3579	3675	3780	3894	3982	4095	4213
		4322	4503	4864	5086	5204	5326	5439	5557	5666
N93MTUSQ9D	Square 90°, Upholstered Back, Diagonal	3377	3490	3579	3675	3780	3894	3982	4095	4213
		4322	4503	4864	5086	5204	5326	5439	5557	5666
LAMINATE BACK										
N93MTLSQ9R	Square 90°, Laminate Back, Right	\$ 4268	4365	4441	4524	4614	4711	4786	4884	4984
		5078	5233	5542	5733	5834	5938	6036	6136	6230
N93MTLSQ9L	Square 90°, Laminate Back, Left	4268	4365	4441	4524	4614	4711	4786	4884	4984
		5078	5233	5542	5733	5834	5938	6036	6136	6230
N93MTLSQ9D	Square 90°, Laminate Back, Diagonal	4268	4365	4441	4524	4614	4711	4786	4884	4984
		5078	5233	5542	5733	5834	5938	6036	6136	6230
VENEER BACK										
N93MTWSQ9R	Square 90°, Veneer Back, Right	\$ 4268	4365	4441	4524	4614	4711	4786	4884	4984
		5078	5233	5542	5733	5834	5938	6036	6136	6230
N93MTWSQ9L	Square 90°, Veneer Back, Left	4268	4365	4441	4524	4614	4711	4786	4884	4984
		5078	5233	5542	5733	5834	5938	6036	6136	6230
N93MTWSQ9D	Square 90°, Veneer Back, Diagonal	4268	4365	4441	4524	4614	4711	4786	4884	4984
		5078	5233	5542	5733	5834	5938	6036	6136	6230

DIMENSIONS

Width	27	Seat Height	18½	Back Height	22½	Weight	92
Depth	27	Seat Depth	20½	Back Width	20½	Cubic Ft.	23.7
Height	40¼	Seat Width	20½				

- Contrasting fabric option – specify X (i.e., N93MTUSQ9RX); see page 231. For list pricing, use your electronic specification tool or contact customer service
- Diagonal model is recommended for directional fabrics
- Power grommet option not available
- Accepts laminate or veneer corner back panels (page 227). The bistro table must be removed for the life of the back panel

FRINGE

TO ORDER, SPECIFY:

1. Model Number
2. Fabric Grade / Cover Number
3. Bistro Table Finish
4. Finish/Laminate (when applicable)
5. Metal Bracket Color
6. Leg Color
7. Glides

- See pages 229-230 for Fringe options
- See pages 264-278 for COM fabric yardage

BISTRO TABLE HIGH BACK SQUARE 90° CORNER

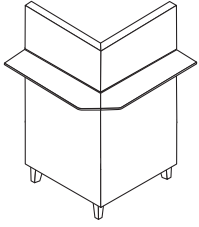

Upholstered Back

MODEL NO.

ALLIANCE PROGRAM PRICE GRADES

		A	B	C	D	E	F	G	H	I
		J	K	L	M	N	O	P	Q	R
UPHOLSTERED BACK										
N93HTUSQ9R	Square 90°, Upholstered Back, Right	\$ 4318	4464	4577	4701	4836	4982	5096	5241	5393
		5533	5765	6230	6516	6667	6824	6969	7121	7261
N93HTUSQ9L	Square 90°, Upholstered Back, Left	4318	4464	4577	4701	4836	4982	5096	5241	5393
		5533	5765	6230	6516	6667	6824	6969	7121	7261
N93HTUSQ9D	Square 90°, Upholstered Back, Diagonal	4318	4464	4577	4701	4836	4982	5096	5241	5393
		5533	5765	6230	6516	6667	6824	6969	7121	7261
LAMINATE BACK										
N93HTLSQ9R	Square 90°, Laminate Back, Right	\$ 5204	5330	5429	5537	5655	5782	5880	6007	6139
		6261	6463	6867	7116	7248	7384	7511	7643	7765
N93HTLSQ9L	Square 90°, Laminate Back, Left	5204	5330	5429	5537	5655	5782	5880	6007	6139
		6261	6463	6867	7116	7248	7384	7511	7643	7765
N93HTLSQ9D	Square 90°, Laminate Back, Diagonal	5204	5330	5429	5537	5655	5782	5880	6007	6139
		6261	6463	6867	7116	7248	7384	7511	7643	7765
VENEER BACK										
N93HTWSQ9R	Square 90°, Veneer Back, Right	\$ 5204	5330	5429	5537	5655	5782	5880	6007	6139
		6261	6463	6867	7116	7248	7384	7511	7643	7765
N93HTWSQ9L	Square 90°, Veneer Back, Left	5204	5330	5429	5537	5655	5782	5880	6007	6139
		6261	6463	6867	7116	7248	7384	7511	7643	7765
N93HTWSQ9D	Square 90°, Veneer Back, Diagonal	5204	5330	5429	5537	5655	5782	5880	6007	6139
		6261	6463	6867	7116	7248	7384	7511	7643	7765

DIMENSIONS

Width	27	Seat Height	18½	Back Height	22½	Weight	119
Depth	27	Seat Depth	20½	Back Width	20½	Cubic Ft.	30.3
Height	53¼	Seat Width	20½				

- Contrasting fabric option – specify X (i.e., N93HTUSQ9RX); see page 231. For list pricing, use your electronic specification tool or contact customer service
- Diagonal model is recommended for directional fabrics
- Power grommet option not available
- Accepts laminate or veneer corner back panels (page 227). The bistro table must be removed for the life of the back panel

TO ORDER, SPECIFY:

1. Model Number
2. Fabric Grade / Cover Number
3. Bistro Table Finish
4. Finish/Laminate (when applicable)
5. Metal Bracket Color
6. Leg Color
7. Glides

- See pages 229-230 for Fringe options
- See pages 264-278 for COM fabric yardage

**BISTRO TABLE
MID BACK
INSIDE 90°
WEDGE**

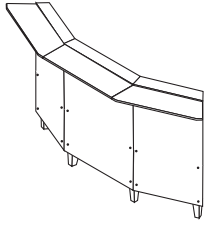

Veneer or Laminate Back

**MODEL
NO.**

ALLIANCE PROGRAM PRICE GRADES

		A	B	C	D	E	F	G	H	I
		J	K	L	M	N	O	P	Q	R
N93MTUIN9	Inside 90°, Upholstered Back	\$ 3692	3835	3946	4068	4200	4343	4455	4598	4746
		4884	5112	5568	5849	5997	6151	6294	6442	6580
N93MTLIN9	Inside 90°, Laminate Back	4073	4170	4246	4329	4419	4516	4591	4689	4789
		4883	5038	5347	5538	5639	5743	5841	5941	6035
N93MTWIN9	Inside 90°, Veneer Back	4073	4170	4246	4329	4419	4516	4591	4689	4789
		4883	5038	5347	5538	5639	5743	5841	5941	6035

DIMENSIONS

Width	63½	Seat Height	18½	Back Height	22½	Weight	166
Depth	27	Seat Depth	20½	Back Width	60	Cubic Ft.	57.9
Height	40¼	Seat Width	55				

- Contrasting fabric option – specify X (i.e., N93MTUIN9X); see page 231. For list pricing, use your electronic specification tool or contact customer service
- Power grommet option not available
- Accepts laminate and veneer divider panels (page 226)

**BISTRO TABLE
MID BACK
INSIDE 90°
ROUND**

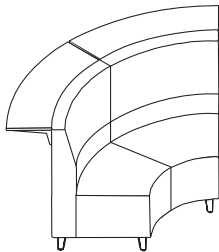

		A	B	C	D	E	F	G	H	I
		J	K	L	M	N	O	P	Q	R
N93MTUINR9	Inside 90°, Upholstered Back	\$ 3935	4094	4218	4353	4501	4660	4784	4943	5109
		5262	5516	6023	6336	6501	6672	6831	6997	7150

DIMENSIONS

Width	63½	Seat Height	18½	Back Height	22½	Weight	196
Depth	32	Seat Depth	20½	Back Width	60	Cubic Ft.	60.2
Height	40¼	Seat Width	55				

- Contrasting fabric option – specify X (i.e., N93MTUINR9X); see page 231. For list pricing, use your electronic specification tool or contact customer service
- Power grommet option not available
- Fabrics with distinct pattern do not lend themselves to the curved design of the round models and are not recommended for use on these units
- Accepts laminate and veneer divider panels (page 226)

**WORKSURFACE
MID BACK
INSIDE 90°
ROUND**

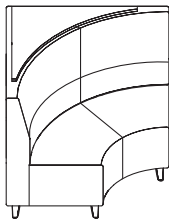

		A	B	C	D	E	F	G	H	I
		J	K	L	M	N	O	P	Q	R
N93MINR9SL	Inside 90°, Laminate Worksurface	\$ 3975	4159	4301	4458	4628	4811	4954	5138	5328
		5505	5797	6382	6743	6933	7130	7314	7504	7681
N93MINR9SW	Inside 90°, Veneer Worksurface	4114	4298	4440	4597	4767	4950	5093	5277	5467
		5644	5936	6521	6882	7072	7269	7453	7643	7820

DIMENSIONS

Width	63½	Seat Height	18½	Back Height	22½	Weight	191
Depth	50¼	Seat Depth	20½	Back Width	60	Cubic Ft.	55.0
Height	40¼	Seat Width	55				

- Contrasting fabric option – specify X (i.e., N93MINR9SWX); see page 231. For list pricing, use your electronic specification tool or contact customer service
- Power grommet option not available on upholstered unit
- G1C Round Grommet, Center option available on worksurface
- Fabrics with distinct pattern do not lend themselves to the curved design of the round models and are not recommended for use on these units
- Accepts laminate and veneer divider panels (page 226)

FRINGE

TO ORDER, SPECIFY:

1. Model Number
2. Fabric Grade / Cover Number
3. Bistro Table Finish
4. Finish/Laminate (when applicable)
5. Metal Bracket Color
6. Leg Color
7. Glides

- See pages 229-230 for Fringe options
- See pages 264-278 for COM fabric yardage

BISTRO TABLE HIGH BACK INSIDE 90° WEDGE

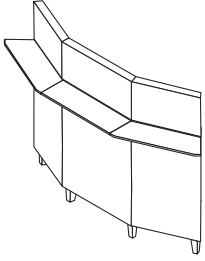

Upholstered Back

MODEL NO.

ALLIANCE PROGRAM PRICE GRADES

			A	B	C	D	E	F	G	H	I
			J	K	L	M	N	O	P	Q	R
N93HTUIN9	Inside 90°, Upholstered Back	\$	4632	4807	4944	5093	5256	5431	5568	5743	5925
			6094	6374	6933	7277	7459	7648	7823	8005	8174
N93HTLIN9	Inside 90°, Laminate Back		5482	5617	5722	5837	5962	6097	6202	6337	6477
			6607	6822	7252	7517	7657	7802	7937	8077	8207
N93HTWIN9	Inside 90°, Veneer Back		5482	5617	5722	5837	5962	6097	6202	6337	6477
			6607	6822	7252	7517	7657	7802	7937	8077	8207

DIMENSIONS

Width	63½	Seat Height	18½	Back Height	35¼	Weight	187
Depth	27	Seat Depth	20½	Back Width	60	Cubic Ft.	73.8
Height	53¼	Seat Width	55				

- Contrasting fabric option – specify X (i.e., N93HTUIN9X); see page 231. For list pricing, use your electronic specification tool or contact customer service
- Power grommet option not available
- Accepts laminate and veneer divider panels (page 226)

BISTRO TABLE HIGH BACK INSIDE 90° ROUND

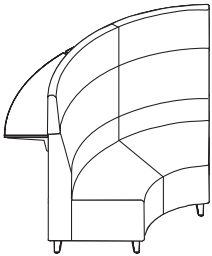

			A	B	C	D	E	F	G	H	I
			J	K	L	M	N	O	P	Q	R
N93HTUINR9	Inside 90°, Upholstered Back	\$	4879	5073	5225	5390	5570	5765	5916	6110	6312
			6499	6809	7428	7809	8011	8220	8414	8616	8803

DIMENSIONS

Width	63½	Seat Height	18½	Back Height	35¼	Weight	217
Depth	32	Seat Depth	20½	Back Width	60	Cubic Ft.	76.7
Height	53¼	Seat Width	55				

- Contrasting fabric option – specify X (i.e., N93HTUINR9X); see page 231. For list pricing, use your electronic specification tool or contact customer service
- Power grommet option not available
- Fabrics with distinct pattern do not lend themselves to the curved design of the round models and are not recommended for use on these units
- Accepts laminate and veneer divider panels (page 226)

FRINGE TABLES PRODUCT SPECIFICATIONS

FRAME CONSTRUCTION

- Grade A slipmatched maple (Brighton, Caramel, Honey, Natural), or cherry veneer (Amber, Autumn, Cordovan, Judicial, Mocha, Truffle) or laminate with mitered corners
- Veneer features a semi-open pore matte sheen
- Wood legs finished with catalyzed top coat which resists denting, peeling and reactions to chemicals
- Can be cleaned with a damp cloth
- When specifying Brighton, Natural, and Sonoma finish, variation in color is acceptable due to the nature of wood characteristics

POWER GROMMET

- 3 power grommets available; specify cutout option and order electrical grommet model separately. See page 797 for details and pricing
- Round black plastic grommet available

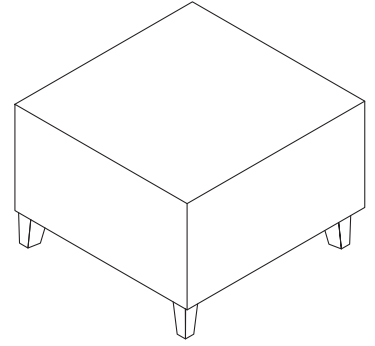

FINISHES

AC Autumn	PB Portobello*
AD Almond*	PT Portico
CL Caramel	SK Skyline*
CW Cordovan	SM Sonoma*
DW Judicial	TF Truffle
HN Honey	405 Designer White*
IM Brighton	462 Cinder*
MC Amber	792 Sable*
MH Mocha	793 Acorn*†
NM Natural	

*Not available on wood inline, corner or end tables
 †Acorn is the finish and laminate complement to Clear Walnut finish

TABLES SURFACE GROMMETS/CUTOUTS

(\$25 list upcharge per location)

G1L Round Grommet, Left
G1R Round Grommet, Right
CUT-G17 G17 Cutout
CUT-G23 G23 Cutout
CUT-G17G1L G17 Cutout & Left Round Grommet
CUT-G17G1R G17 Cutout & Right Round Grommet
CUT-G23G1L G23 Cutout & Left Grommet
CUT-G23G1R G23 Cutout & Right Round Grommet
X No Grommet

INLINE TABLE WITH GROMMETS/CUTOUTS

*End table has same cutout locations

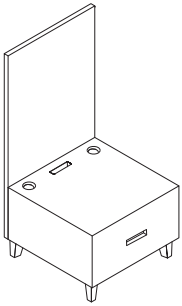

INLINE CORNER TABLE WITH GROMMETS/CUTOUTS

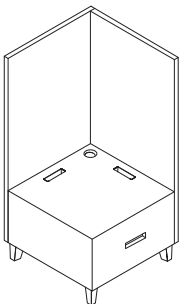

LAMINATE

AC2 Autumn 2	PB Portobello
AD Almond	PT Portico
CL Caramel	SK Skyline
CW Cordovan	SM Sonoma
DW Judicial	TF Truffle
HN2 Honey 2	405 Designer White
IM Brighton	462 Cinder
MC Amber	792 Sable
MH Mocha	793 Acorn†
NM Natural	

TABLES SIDE GROMMETS/CUTOUTS

(\$25 list upcharge per location)

CUT-G23C G23 Cutout
X No Grommet

If specifying cutout, reference page 797 for pricing and details to order power grommet.

DOUBLE INLINE TABLE WITH GROMMETS/CUTOUTS

*Half round table has same cutout locations on the surface

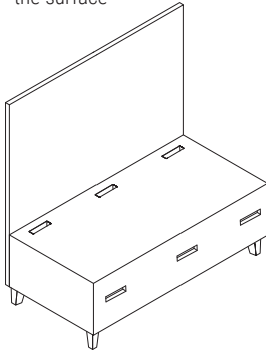

DOUBLE INLINE TABLE WITH SHELF AND WITH GROMMETS/CUTOUTS

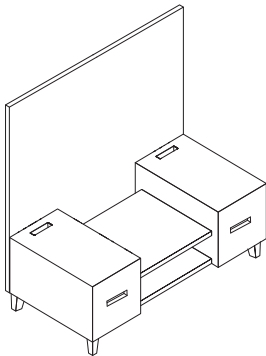

Center surface grommet not available on Media Table

GALLERY LAMINATE

Grade 1 – 5% upcharge		
G1001 Citadel	G1011	Pepperdust
Grade 2 – 6% upcharge		
G1002 Planked Raw Oak	G1007	Serotina
G1003 Evening Notte	G1008	Timeless
G1004 Kirsche	G1009	White Nebbia
G1005 Midnight Run	G1012	Phantom Ecru
G1006 Sepia Walnut		

See page 20 for Gallery program details and upcharges

GLIDES

STD Standard
C10 Soft (add \$30 list)

METAL LEG/BASE COLORS

423 Concrete
462 Cinder
463 Iron
497 Polished Aluminum
501 Platinum Metallic
503 Satin Nickel Metallic

¼ ROUND AND ½ ROUND TABLES SURFACE GROMMETS/CUTOUTS

(\$25 list upcharge per location)

X No Grommet
CUT-G17A G17 Cutout, All
CUT-G17C G17 Cutout, Center
*CUT-G17L G17 Cutout, Left
*CUT-G17LR G17 Cutout, Left & Right
*CUT-G17R G17 Cutout, Right
CUT-G23A G23 Cutout, All
CUT-G23C G23 Cutout, Center
*CUT-G23L G23 Cutout, Left
*CUT-G23LR G23 Cutout, Left & Right
*CUT-G23R G23 Cutout, Right
G1A Round Grommet, All
G1C Round Grommet, Center
*G1L Round Grommet, Left
*G1LR Round Grommet, Left & Right
*G1R Round Grommet, Right

*¼ Round options

SOLID SURFACE COLORS

7101 Bisque (Grade A)
7201 Glacier White (Grade A)
7202 Canyon (Grade B)
7203 Designer White (Grade B)
7204 Silt (Grade B)
7301 Concrete (Grade C)
7302 Deep Night Sky (Grade C)
7303 Deep Nocturne (Grade C)

SOLID SURFACE RIM PROFILE



TO ORDER, SPECIFY:

1. Model Number
2. Surface Grommet
3. Side Grommet
4. Wood/Laminate Finish
5. Leg Color
6. Glides

• See page 250 for Fringe options

END TABLE

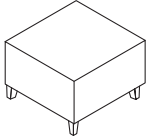

MODEL NO. LIST PRICE

N93TEN2724W	Wood, Metal Legs - 24"	\$ 1545
N93TEN2724WW	Wood, Wood Legs - 24"	1681
N93TEN2724L	Laminate, Metal Legs - 24"	1405
N93TEN2724LW	Laminate, Wood Legs - 24"	1540

DIMENSIONS - 24"

Width	23½	Weight	55
Depth	26½	Cubic Ft.	13.5
Height	19½		

- To be used when aligning with 24" width

N93TEN2727W	Wood, Metal Legs - 27"	\$ 1627
N93TEN2727WW	Wood, Wood Legs - 27"	1769
N93TEN2727L	Laminate, Metal Legs - 27"	1479
N93TEN2727LW	Laminate, Wood Legs - 27"	1621

DIMENSIONS - 27"

Width	26½	Weight	61
Depth	26½	Cubic Ft.	13.5
Height	19½		

- Power grommet is sold separately; reference page 797 for pricing and details
- Power grommet cutout is always center
- To be used when aligning with 27" depth

QUARTER TABLE

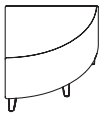

N93TQRW	Wood, Metal Legs	\$ 2065
N93TQRWW	Wood, Wood Legs	2247
N93TQRL	Laminate, Metal Legs	1877
N93TQRLW	Laminate, Wood Legs	2059

DIMENSIONS

Width	26½	Weight	40
Depth	26½	Cubic Ft.	10.7
Height	19½		

- Power grommet is sold separately; reference page 797 for pricing and details
- No side grommet option

FRINGE

TO ORDER, SPECIFY:

1. Model Number
2. Surface Grommet
3. Side Grommet
4. Wood/Laminate Finish
5. Leg Color
6. Glides

• See page 250 for Fringe options

HALF ROUND TABLE

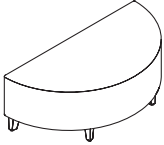

MODEL NO.		LIST PRICE
-----------	--	------------

N93THRW	Wood, Metal Legs	\$ 2570
N93THRWW	Wood, Wood Legs	2796
N93THRLL	Laminate, Metal Legs	2336
N93THRLW	Laminate, Wood Legs	2562

DIMENSIONS

Width	53	Weight	77
Depth	26½	Cubic Ft.	20.5
Height	19½		

- Power grommet is sold separately; reference page for pricing and details
- No side grommet option

MID BACK INLINE TABLE

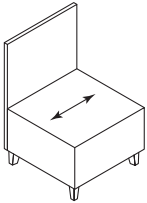

N93TMIBW	Ganging Wood, Metal Legs	\$ 1881
N93TMIBWW	Ganging Wood, Wood Legs	2018
N93TMIBL	Ganging Laminate, Metal Legs	1684
N93TMIBLW	Ganging Laminate, Wood Legs	1820

DIMENSIONS

Width	23½	Weight	97
Depth	26½	Cubic Ft.	7.4
Height	40		

- Power grommet is sold separately; reference page 797 for pricing and details
- Power grommet cutout is always center

HIGH BACK INLINE TABLE

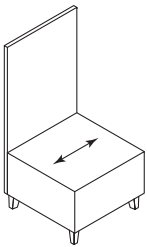

N93THIBW	Ganging Wood, Metal Legs	\$ 1938
N93THIBWW	Ganging Wood, Wood Legs	2074
N93THIBL	Ganging Laminate, Metal Legs	1740
N93THIBLW	Ganging Laminate, Wood Legs	1877

DIMENSIONS

Width	23½	Weight	109
Depth	26½	Cubic Ft.	7.7
Height	53		

- Power grommet is sold separately; reference page 797 for pricing and details
- Power grommet cutout is always center

TO ORDER, SPECIFY:

1. Model Number
2. Surface Grommet
3. Side Grommet
4. Wood/Laminate Finish
5. Leg Color
6. Glides

• See page 250 for Fringe options

**MID BACK
INLINE CORNER TABLE**

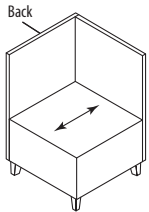

Left

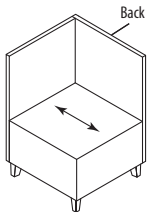

Right



Mid Back Corner Table
Back View - Right

**MODEL
NO.**

LIST PRICE

N93TMCLW	Left Corner Wood, Metal Legs	\$ 2334
N93TMCLWW	Left Corner Wood, Wood Legs	2478
N93TMCLL	Left Corner Laminate, Metal Legs	2070
N93TMCLLW	Left Corner Laminate, Wood Legs	2213
N93TMCRW	Right Corner Wood, Metal Legs	2334
N93TMCRWW	Right Corner Wood, Wood Legs	2478
N93TMCRCL	Right Corner Laminate, Metal Legs	2070
N93TMCRCLW	Right Corner Laminate, Wood Legs	2213

DIMENSIONS

Width	26½
Depth	26½
Height	40

Weight	130
Cubic Ft.	7.5

- Power grommet is sold separately; reference page 797 for pricing and details
- Power grommet cutout is always center
- When specifying Cinder as the leg color, decorative fasteners will be black
- When specifying Concrete, Iron, Polished Aluminum, Platinum Metallic, or Satin Nickel Metallic as the leg color, decorative fasteners will be Polished Aluminum

FRINGE

TO ORDER, SPECIFY:

1. Model Number
2. Surface Grommet
3. Side Grommet
4. Wood/Laminate Finish
5. Leg Color
6. Glides

• See page 250 for Fringe options

HIGH BACK INLINE CORNER TABLE

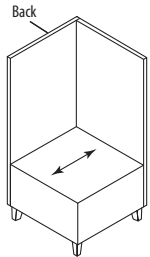

Left

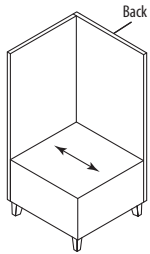

Right

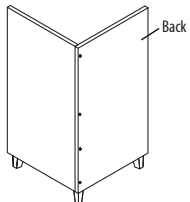

High Back Corner Table
Back View - Left

MODEL NO.

LIST PRICE

N93THCLW	Left Corner Wood, Metal Legs	\$ 2452
N93THCLWW	Left Corner Wood, Wood Legs	2596
N93THCLL	Left Corner Laminate, Metal Legs	2187
N93THCLLW	Left Corner Laminate, Wood Legs	2331
N93THCRW	Right Corner Wood, Metal Legs	2452
N93THCRWW	Right Corner Wood, Wood Legs	2596
N93THCRL	Right Corner Laminate, Metal Legs	2187
N93THCRLW	Right Corner Laminate, Wood Legs	2331

DIMENSIONS

Width	26½
Depth	26½
Height	53

Weight	152
Cubic Ft.	7.9

- Power grommet is sold separately; reference page 797 for pricing and details
- Power grommet cutout is always center
- When specifying Cinder as the leg color, decorative fasteners will be black
- When specifying Concrete, Iron, Polished Aluminum, Platinum Metallic, or Satin Nickel Metallic as the leg color, decorative fasteners will be Polished Aluminum

TO ORDER, SPECIFY:

1. Model Number
2. Surface Grommet
3. Side Grommet
4. Wood/Laminate Finish
5. Leg Color
6. Glides

• See page 250 for Fringe options

**MID BACK
DOUBLE INLINE TABLE**

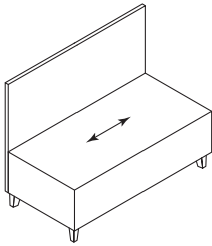

MODEL NO. LIST PRICE

LAMINATE

N93TMIB18L	18" Depth, Metal Legs	\$ 3144
N93TMIB18LW	18" Depth, Wood Legs	3279
N93TMIB27L	27" Depth, Metal Legs	3369
N93TMIB27LW	27" Depth, Wood Legs	3505

VENEER

N93TMIB18W	18" Depth, Metal Legs	\$ 3537
N93TMIB18WW	18" Depth, Wood Legs	3673
N93TMIB27W	27" Depth, Metal Legs	3763
N93TMIB27WW	27" Depth, Wood Legs	3897

DIMENSIONS

Width	47	18" Weight	142
Depth	18 or 27	18" Cubic Ft.	8.5
Height	40	27" Weight	161
		27" Cubic Ft.	11.8

- Power grommet is sold separately; reference page 797 for pricing and details
- Power grommet cutout is always center

**HIGH BACK
DOUBLE INLINE TABLE**

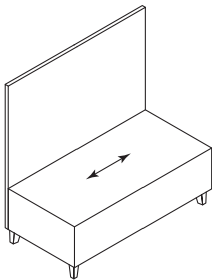

LAMINATE

N93THIB18L	18" Depth, Metal Legs	\$ 3256
N93THIB18LW	18" Depth, Wood Legs	3391
N93THIB27L	27" Depth, Metal Legs	3482
N93THIB27LW	27" Depth, Wood Legs	3618

VENEER

N93THIB18W	18" Depth, Metal Legs	\$ 3537
N93THIB18WW	18" Depth, Wood Legs	3673
N93THIB27W	27" Depth, Metal Legs	3763
N93THIB27WW	27" Depth, Wood Legs	3897

DIMENSIONS

Width	47	18" Weight	168
Depth	18 or 27	18" Cubic Ft.	8.5
Height	53	27" Weight	185
		27" Cubic Ft.	11.8

- Power grommet is sold separately; reference page 797 for pricing and details
- Power grommet cutout is always center

FRINGE

TO ORDER, SPECIFY:

1. Model Number
2. Surface Grommet
3. Side Grommet
4. Wood/Laminate Finish
5. Leg Color
6. Glides

• See page 250 for Fringe options

MID BACK DOUBLE INLINE TABLE WITH SHELF

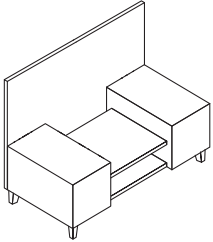

MODEL NO.		LIST PRICE
-----------	--	------------

LAMINATE

N93TMIBS18L	18" Depth, Metal Legs	\$ 3361
N93TMIBS18LW	18" Depth, Wood Legs	3498
N93TMIBS27L	27" Depth, Metal Legs	3587
N93TMIBS27LW	27" Depth, Wood Legs	3723

VENEER

N93TMIBS18W	18" Depth, Metal Legs	\$ 3754
N93TMIBS18WW	18" Depth, Wood Legs	3892
N93TMIBS27W	27" Depth, Metal Legs	3980
N93TMIBS27WW	27" Depth, Wood Legs	4116

DIMENSIONS

Width	47	18" Weight	168
Depth	18 or 27	18" Cubic Ft.	8.5
Height	40	27" Weight	185
		27" Cubic Ft.	11.8

- Power grommet is sold separately; reference page 797 for pricing and details
- Power grommet cutout is always center

HIGH BACK DOUBLE INLINE TABLE WITH SHELF

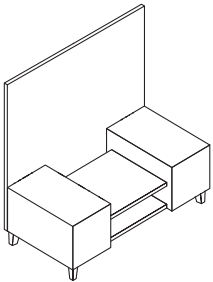

LAMINATE

N93THIBS18L	18" Depth, Metal Legs	\$ 3474
N93THIBS18LW	18" Depth, Wood Legs	3609
N93THIBS27L	27" Depth, Metal Legs	3699
N93THIBS27LW	27" Depth, Wood Legs	3836

VENEER

N93THIBS18W	18" Depth, Metal Legs	\$ 3754
N93THIBS18WW	18" Depth, Wood Legs	3892
N93THIBS27W	27" Depth, Metal Legs	3980
N93THIBS27WW	27" Depth, Wood Legs	4116

DIMENSIONS

Width	47	18" Weight	200
Depth	18 or 27	18" Cubic Ft.	8.5
Height	53	27" Weight	218
		27" Cubic Ft.	11.8

- Power grommet is sold separately; reference page 797 for pricing and details
- Power grommet cutout is always center

TO ORDER, SPECIFY:

1. Model Number
2. Surface Grommet
3. Side Grommet
4. Wood/Laminate Finish
5. Leg Color
6. Glides

• See page 250 for Fringe options

**HIGH BACK
DOUBLE INLINE
MEDIA TABLE**

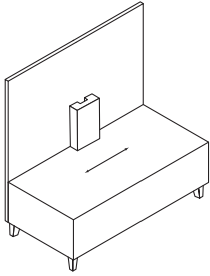

MODEL NO. LIST PRICE

LAMINATE

N93THIBV18L	18" Depth, Metal Legs	\$ 3585
N93THIBV18LW	18" Depth, Wood Legs	3719
N93THIBV27L	27" Depth, Metal Legs	3808
N93THIBV27LW	27" Depth, Wood Legs	3945

VENEER

N93THIBV18W	18" Depth, Metal Legs	\$ 3977
N93THIBV18WW	18" Depth, Wood Legs	4113
N93THIBV27W	27" Depth, Metal Legs	4202
N93THIBV27WW	27" Depth, Wood Legs	4337

DIMENSIONS

Width	47	18" Weight	168
Depth	18 or 27	18" Cubic Ft.	8.5
Height	53	27" Weight	185
		27" Cubic Ft.	11.8

- Includes TV mounting kit
- Center surface grommet not available
- Power grommet is sold separately; reference page 797 for pricing and details

**HIGH BACK
DOUBLE INLINE
MEDIA TABLE WITH SHELF**

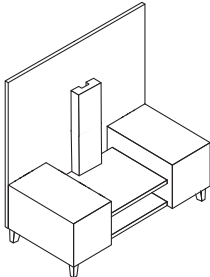

LAMINATE

N93THIBVS18L	18" Depth, Metal Legs	\$ 4129
N93THIBVS18LW	18" Depth, Wood Legs	4265
N93THIBVS27L	27" Depth, Metal Legs	4352
N93THIBVS27LW	27" Depth, Wood Legs	4490

VENEER

N93THIBVS18W	18" Depth, Metal Legs	\$ 4521
N93THIBVS18WW	18" Depth, Wood Legs	4657
N93THIBVS27W	27" Depth, Metal Legs	4748
N93THIBVS27WW	27" Depth, Wood Legs	4882

DIMENSIONS

Width	47	18" Weight	200
Depth	18 or 27	18" Cubic Ft.	8.5
Height	53	27" Weight	218
		27" Cubic Ft.	11.8

- Includes TV mounting kit
- Power grommet is sold separately; reference page 797 for pricing and details
- Power grommet cutout is always center

FRINGE

TO ORDER, SPECIFY:

1. Model Number
2. Wood/Laminate Finish (when applicable)

• See page 250 for Fringe options

FLAT PANEL WALL MOUNT KIT

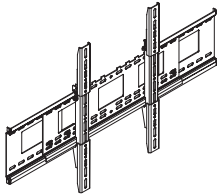

MODEL NO.	GRADE / LIST PRICE	CARTONED WEIGHT	CUBIC FEET
15NTVMAS	Black \$ 358		

DIMENSIONS

Depth	15¼-47¼	Weight	25
Height	15¼-31¼	Cubic Ft.	2.0

- Adjustable Universal Wall Mount adjusts to allow installation of most 32" to 80" flat panel
- Must mount onto an architectural wall
- Black powder coat
- VESA mounting compliant

SET-ON RECTANGLE WORKSURFACE

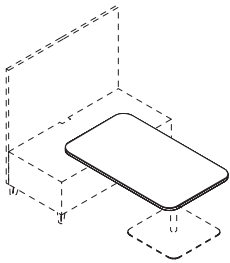

SOFTENED EDGE

30" x 60"

N93TRT3060W	Wood	\$ 1446	62 lbs	3.6
N93TRT3060L	Laminate	964	62 lbs	3.6

30" x 84"

N93TRT3084W	Wood	\$ 1639	90 lbs	5.2
N93TRT3084L	Laminate	1156	90 lbs	5.2

KNIFE EDGE

30" x 60"

N93TRT3060WK	Wood	\$ 1790	76 lbs	5.2
N93TRT3060LK	Laminate	1307	76 lbs	4.4

30" x 84"

N93TRT3084WK	Wood	\$ 2120	104 lbs	5.8
N93TRT3084LK	Laminate	1446	104 lbs	5.8

SOLID SURFACE

30" x 60"

		GRADE A	GRADE B	GRADE C		
N93TRT3060S	Solid Surface	\$ 3281	3466	3703	65 lbs	6.6

30" x 84"

N93TRT3084S	Solid Surface	\$ 4255	4510	4837	88 lbs	9.1
-------------	---------------	---------	------	------	--------	-----

- Recommended for use with Fringe double inline or double inline media tables
- Attachment hardware included with collaborative height bases
- Requires 1 leveling disk base
- Inline table surface will be defaced when worksurface is attached
- 60" table works with 2 seat lounge
- 84" table works with 3 seat lounge

TO ORDER, SPECIFY:

• See page 250 for Fringe options

1. Model Number

**ROUND LEVELING
DISC BASE
COLLABORATIVE HEIGHT**

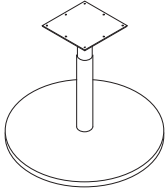

MODEL NO.		LIST PRICE	CARTONED WEIGHT	CUBIC FEET
CBV2219DLC	Concrete	\$ 783	50 lbs	2.6
CBV2219DLB	Cinder	783	50 lbs	2.6
CBV2219DLI	Iron	783	50 lbs	2.6
CBV2219DLS	Platinum Metallic	783	50 lbs	2.6
CBV2219DLN	Satin Nickel Metallic	783	50 lbs	2.6

DIMENSIONS

Width 22
Diameter 3
Height 19-20½

- Not to be used in freestanding table application
- Attachment hardware for set-on worksurfaces included

**SQUARE LEVELING
DISC BASE
COLLABORATIVE HEIGHT**

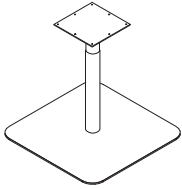

CBV2219SQDLC	Concrete	\$ 902	50 lbs	2.6
CBV2219SQDLB	Cinder	902	50 lbs	2.6
CBV2219SQDLI	Iron	902	50 lbs	2.6
CBV2219SQDLS	Platinum Metallic	902	50 lbs	2.6
CBV2219SQDLN	Satin Nickel Metallic	902	50 lbs	2.6

DIMENSIONS

Width 22
Diameter 3
Height 19-20½

- Not to be used in freestanding table application
- Attachment hardware for set-on worksurfaces included

FRINGE

TO ORDER, SPECIFY:

• See page 250 for Fringe options

1. Model Number

FREESTANDING RECTANGLE WORKSURFACE



MODEL NO.		GRADE / LIST PRICE			CARTONED WEIGHT	CUBIC FEET
		GRADE A	GRADE B	GRADE C		
SOFTENED EDGE						
30" x 48"						
N93TRT3048W	Wood	\$	1256		67 lbs	2.8
N93TRT3048L	Laminate		838		67 lbs	2.8
30" x 72"						
N93TRT3072W	Wood	\$	1569		95 lbs	4.0
N93TRT3072L	Laminate		1046		95 lbs	4.0
KNIFE EDGE						
30" x 48"						
N93TRT3048WK	Wood	\$	1532		67 lbs	2.8
N93TRT3048LK	Laminate		1022		67 lbs	2.8
30" x 72"						
N93TRT3072WK	Wood	\$	1942		95 lbs	4.0
N93TRT3072LK	Laminate		1295		95 lbs	4.0
SOLID SURFACE						
30" x 48"						
N93TRT3048S	Solid Surface	\$	2812	2963	3158	52 lbs
30" x 72"						
N93TRT3072S	Solid Surface	\$	3781	4002	4287	78 lbs

- Requires 2 bases
- 48" table works with 2 seat lounge
- 72" table works with 3 seat lounge

TO ORDER, SPECIFY:

• See page 250 for Fringe options

1. Model Number

ROUND DISC BASE

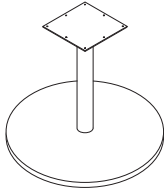

MODEL NO.		LIST PRICE	CARTONED WEIGHT	CUBIC FEET
CBV2219DC	Concrete	\$ 745	45 lbs	2.3
CBV2219DB	Cinder	745	45 lbs	2.3
CBV2219DI	Iron	745	45 lbs	2.3
CBV2219DS	Platinum Metallic	745	45 lbs	2.3
CBV2219DN	Satin Nickel Metallic	745	45 lbs	2.3

DIMENSIONS

Width 22
 Diameter 3
 Height 19½

• Not to be used in set-on table application

SQUARE DISC BASE

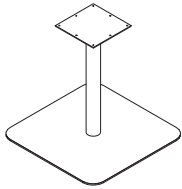

CBV2219SQDC	Concrete	\$ 864	45 lbs	2.3
CBV2219SQDB	Cinder	864	45 lbs	2.3
CBV2219SQDI	Iron	864	45 lbs	2.3
CBV2219SQDS	Platinum Metallic	864	45 lbs	2.3
CBV2219SQDN	Satin Nickel Metallic	864	45 lbs	2.3

DIMENSIONS

Width 22
 Diameter 3
 Height 19½

• Not to be used in set-on table application

FRINGE

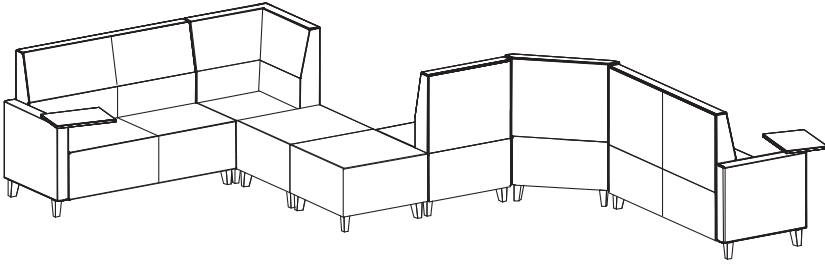

MODEL NO.	QUANTITY	DESCRIPTION	GRADE A LIST PRICE
N93B1S27	(2)	Single Seat Bench	\$ 1504 ea
N93M2RR	(2)	Mid Back 2 Seat Right Arm With Tablet	3184 ea
N93M1M	(1)	Mid Back Single Seat Armless	1790
N93MSQ9D	(1)	Mid Back Square 90° Corner	2458
N93MOU9	(1)	Mid Back Outside 90° Wedge	2737
N93GB2	(5)	Ganging Bracket Kit	74 ea
Total			\$ 16,731

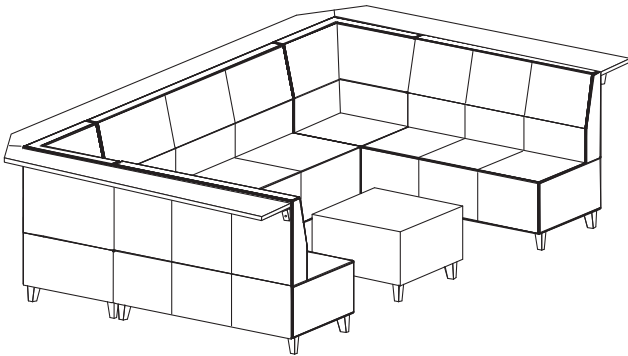

MODEL NO.	QUANTITY	DESCRIPTION	GRADE A LIST PRICE
N93MTU3M	(3)	Bistro Table Mid Back 3 Seat upholstered Back	\$ 4784 ea
N93MTUSQ9R	(1)	Bistro Table Mid Back Square 90° Corner, right	3377
N93MTUSQ9L	(1)	Bistro Table Mid Back Square 90° Corner, left	3377
N93TEN2727L	(1)	End Table Laminate	1621
N93GB2	(8)	Ganging Bracket Kit	74 ea
Total			\$ 23,177

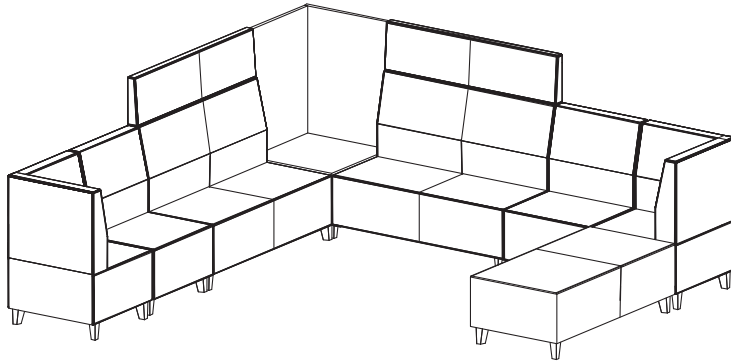

MODEL NO.	QUANTITY	DESCRIPTION	GRADE A LIST PRICE
N93MSQ9D	(2)	Mid Back Square 90° Corner	\$ 2458 ea
N93M1M	(2)	Mid Back Single Seat Armless	1790 ea
N93H2M	(2)	High Back 2 Seat Armless	3761 ea
N93THCLL	(1)	High Back Inline Corner Table Laminate (Right Or Left)	2331
N93B2S48	(1)	2 Seat Bench	1843
N93GB2	(7)	Ganging Bracket Kit	74 ea
Total			\$ 20,710

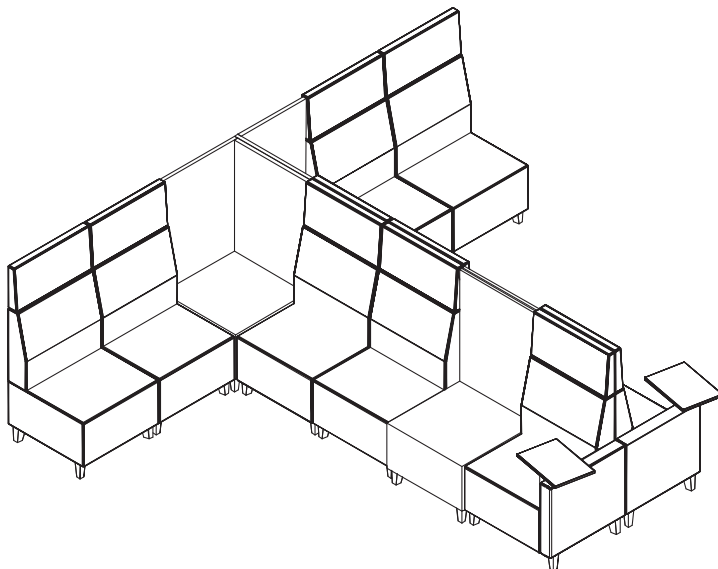

MODEL NO.	QUANTITY	DESCRIPTION	GRADE A LIST PRICE
N93H2M	(4)	High Back 2 Seat Armless	\$ 3761 ea
N93H1RR	(1)	High Back Single Seat Right Arm with Tablet	2940
N93H1LL	(1)	High Back Single Seat Left Arm With Tablet	2940
N93THCRL	(1)	High Back Inline Corner Table Right Laminate	2331
N93THCLL	(1)	High Back Inline Corner Table Left Laminate	2331
N93THIBL	(2)	High Back Inline Table Laminate	1877 ea
N93GB2	(8)	Ganging Bracket Kit	74 ea
Total			\$ 29,932

COM YARDAGE REQUIREMENTS

COM YARDAGE REQUIREMENTS (54" WIDTH – CUT UP THE ROLL)

MODEL	RAILROADED Contact customer service 800-634-9510 for ydg requirements	NON DIRECTIONAL OR SOLID	1"-4" REPEAT	5"-11" REPEAT	12"-18" REPEAT	COL SQUARE FEET
			4" VERTICAL X 4" HORIZONTAL	11" VERTICAL X 11" HORIZONTAL	18" VERTICAL X 18" HORIZONTAL	
N93B1S24		1.53	3.25	4.00	4.75	30.5
N93B1S27		2.69	3.25	4.00	4.00	53.7
N93B2S48		2.31	5.25	6.00	7.50	46
N93B2S54		4.39	5.50	6.00	6.00	87.4
N93B3S71		3.22	7.50	8.50	10.00	64.2
N93B3S80		6.08	7.50	8.25	8.25	121.2
N93BCR64		2.64	3.68	5.12	5.23	50.89
N93BHR54		2.57	3.79	3.90	4.52	49.63
N93BQR27		2.07	2.68	2.98	3.00	39.5
N93BWD64		2.69	4.00	5.00	5.00	53.7
N93CSA, N93CSAC, N93CSAL, N93CSALC, N93CSAR, N93CSARC		3.40	4.30	6.50	6.50	67
N93CSACX, N93CSALCX, N93CSALX, N93CSARCX, N93CSARX, N93CSAX	Back Seat Arm	1.70 1.20 1.80	2.00 1.30 2.00	2.30 3.00 3.30	3.00 3.00 3.30	33 23 35
N93CSLL, N93CSLLC, N93CSR, N93CSRRC		2.80	3.50	5.50	5.50	55
N93CSLLCX, N93CSLLX, N93CSRRCX, N93CSRXX	Back Seat Arm	1.70 1.20 1.00	2.00 1.30 1.50	2.30 3.00 1.80	3.00 3.00 2.00	33 23 19
N93CSM, N93CSMC		2.20	3.00	4.50	4.50	43
N93CSMCX, N93CSMX	Back	1.70	2.00	2.30	3.00	33
N93H10RH, N93H1LH, N93H1OLH, N93H1RH		6.30	8.80	11.50	12.00	126
N93H10RHX, N93H1LHX, N93H1OLHX, N93H1RHX	Back Seat Lumbar Extreme Accent Arm	1.20 1.60 0.90 1.20 0.70 3.00	1.50 2.00 1.00 2.00 0.80 3.30	2.00 3.50 1.30 2.00 1.00 4.50	2.00 4.00 1.50 2.50 1.30 4.50	24 31 17 24 13 60
N93H1B, N93H1BL, N93H1BR, N93H1OB		6.10	8.90	11.60	12.80	122
N93H1BH, N93H1OBH		9.10	11.50	14.50	15.00	182
N93H1BHX, N93H1OBH	Back Seat Lumbar Extreme Accent Arm	1.20 1.60 0.90 1.20 0.70 5.80	1.50 2.00 1.00 2.00 0.80 6.00	2.00 3.50 1.30 2.00 1.00 7.50	2.00 4.00 1.50 2.50 1.30 7.50	24 31 17 24 13 116
N93H1BLX, N93H1BRX, N93H1BX, N93H1OBX	Back Seat Lumbar Extreme Accent Arm	1.20 1.60 0.90 1.20 0.70 2.90	1.50 2.00 1.00 2.00 0.80 3.40	2.00 3.50 1.30 2.00 1.00 4.60	2.00 4.00 1.50 2.50 1.30 5.00	24 31 17 24 13 56
N93H1BM, N93H1OBM		7.70	10.30	13.00	14.50	153
N93H1BMX, N93H1OBMX	Back Seat Lumbar Extreme Accent Arm	1.20 1.60 0.90 1.20 0.70 4.40	1.50 2.00 1.00 2.00 0.80 4.80	2.00 3.50 1.30 2.00 1.00 6.00	2.00 4.00 1.50 2.50 1.30 7.00	24 31 17 24 13 87
N93H1L, N93H1LL, N93H1OL, N93H1OR, N93H1R, N93H1RR		4.90	7.30	9.80	10.50	97

COM YARDAGE REQUIREMENTS

COM YARDAGE REQUIREMENTS (54" WIDTH – CUT UP THE ROLL)

MODEL	RAILOADED Contact customer service 800-634-9510 for ydg requirements	NON DIRECTIONAL OR SOLID	1"-4" REPEAT	5"-11" REPEAT	12"-18" REPEAT	COL SQUARE FEET
			4" VERTICAL X 4" HORIZONTAL	11" VERTICAL X 11" HORIZONTAL	18" VERTICAL X 18" HORIZONTAL	
N93H1LLX, N93H1LX, N93H1OLX, N93H1ORX, N93H1RRX, N93H1RX	Back	1.20	1.50	2.00	2.00	24
	Seat	1.60	2.00	3.50	4.00	31
	Lumbar	0.90	1.00	1.30	1.50	17
	Extreme	1.20	2.00	2.00	2.50	24
	Accent	0.70	0.80	1.00	1.30	13
	Arm	1.60	1.80	2.80	3.00	31
N93H1M, N93H1OM		3.30	5.50	7.00	7.50	66
N93H1MX, N93H1OMX	Back	1.20	1.50	2.00	2.00	24
	Seat	1.60	2.00	3.50	4.00	31
	Lumbar	0.90	1.00	1.30	1.50	17
	Extreme	1.20	2.00	2.00	2.50	24
	Accent	0.70	0.80	1.00	1.30	13
	Arm	1.60	1.80	2.80	3.00	31
N93H1OLM, N93H1ORM, N93H1RM		5.60	8.00	11.00	11.80	111
N93H1OLMX, N93H1ORMX, N93H1RMX	Back	1.20	1.50	2.00	2.00	24
	Seat	1.60	2.00	3.50	4.00	31
	Lumbar	0.90	1.00	1.30	1.50	17
	Extreme	1.20	2.00	2.00	2.50	24
	Accent	0.70	0.80	1.00	1.30	13
	Arm	2.30	2.50	4.00	4.30	45
N93H20BH, N93H2BH		10.90	15.00	19.00	19.00	218
N93H20BHX, N93H2BHX	Back	1.20	1.30	2.50	2.50	24
	Seat	1.90	3.50	4.60	5.50	38
	Lumbar	0.90	1.50	2.00	2.00	17
	Extreme	1.60	3.50	4.00	4.30	31
	Accent	1.00	1.30	1.50	2.00	19
	Arm	5.80	6.00	7.50	7.50	116
N93H20BM, N93H2BM		9.50	13.80	17.50	18.50	189
N93H20BMX, N93H2BMX	Back	1.20	1.30	2.50	2.50	24
	Seat	1.90	3.50	4.60	5.50	38
	Lumbar	0.90	1.50	2.00	2.00	17
	Extreme	1.60	3.50	4.00	4.30	31
	Accent	1.00	1.30	1.50	2.00	19
	Arm	4.40	4.80	6.00	7.00	87
N93H2B, N93H2BB, N93H2BL, N93H2BR, N93H2OB		7.90	12.40	16.10	16.50	158
N93H2BBX, N93H2BLX, N93H2BRX, N93H2BX, N93H2OBX	Back	1.20	1.30	2.50	2.50	24
	Seat	1.90	3.50	4.60	5.50	38
	Lumbar	0.90	1.50	2.00	2.00	17
	Extreme	1.60	3.50	4.00	4.30	31
	Accent	1.00	1.30	1.50	2.00	19
	Arm	2.90	3.40	4.60	5.00	56
N93H2L, N93H2LL, N93H2OL, N93H2OR, N93H2R, N93H2RR		6.70	10.80	14.30	14.50	133
N93H2LH, N93H2OLH, N93H2ORH, N93H2RH		8.10	12.30	16.00	16.00	162
N93H2LHX, N93H2OLHX, N93H2ORHX, N93H2RHX	Back	1.20	1.30	2.50	2.50	24
	Seat	1.90	3.50	4.60	5.50	38
	Lumbar	0.90	1.50	2.00	2.00	17
	Extreme	1.60	3.50	4.00	4.30	31
	Accent	1.00	1.30	1.50	2.00	19
	Arm	3.00	3.30	4.50	4.50	60
N93H2LLX, N93H2LX, N93H2OLX, N93H2ORX, N93H2RRX, N93H2RX	Back	1.20	1.30	2.50	2.50	24
	Seat	1.90	3.50	4.60	5.50	38
	Lumbar	0.90	1.50	2.00	2.00	17
	Extreme	1.60	3.50	4.00	4.30	31
	Accent	1.00	1.30	1.50	2.00	19
	Arm	1.60	1.80	2.80	3.00	31
N93H2LM, N93H2OLM, N93H2ORM, N93H2RM		7.40	11.50	15.50	15.80	147

COM YARDAGE REQUIREMENTS

COM YARDAGE REQUIREMENTS (54" WIDTH – CUT UP THE ROLL)

MODEL	RAILROADED Contact customer service 800-634-9510 for ydg requirements	NON DIRECTIONAL OR SOLID	1"-4" REPEAT	5"-11" REPEAT	12"-18" REPEAT	COL SQUARE FEET
			4" VERTICAL X 4" HORIZONTAL	11" VERTICAL X 11" HORIZONTAL	18" VERTICAL X 18" HORIZONTAL	
N93H2LMX, N93H2OLMX, N93H2ORMX, N93H2RMX	Back	1.20	1.30	2.50	2.50	24
	Seat	1.90	3.50	4.60	5.50	38
	Lumbar	0.90	1.50	2.00	2.00	17
	Extreme	1.60	3.50	4.00	4.30	31
	Accent	1.00	1.30	1.50	2.00	19
	Arm	2.30	2.50	4.00	4.30	45
N93H2M, N93H2OM		5.10	9.00	11.50	11.50	102
N93H2MX, N93H2OMX	Back	1.20	1.30	2.50	2.50	24
	Seat	1.90	3.50	4.60	5.50	38
	Lumbar	0.90	1.50	2.00	2.00	17
	Extreme	1.60	3.50	4.00	4.30	31
	Accent	1.00	1.30	1.50	2.00	19
	N93H3B, N93H3BB, N93H3BL, N93H3BR, N93H3OB		9.90	16.90	21.10	22.00
N93H3BBX, N93H3BLX, N93H3BRX, N93H3BX, N93H3OBX	Back	1.70	2.00	2.80	4.30	33
	Seat	2.50	4.50	6.30	7.50	50
	Lumbar	1.10	2.00	2.30	3.00	22
	Extreme	2.30	3.80	1.30	4.80	43
	Accent	1.10	2.00	2.30	3.00	22
	Arm	2.90	3.40	4.60	5.00	56
N93H3BH, N93H3OBH		12.90	19.50	24.00	24.50	257
N93H3BHX, N93H3OBHX	Back	1.70	2.00	2.80	4.30	33
	Seat	2.50	4.50	6.30	7.50	50
	Lumbar	1.10	2.00	2.30	3.00	22
	Extreme	2.30	3.80	1.30	4.80	43
	Accent	1.10	2.00	2.30	3.00	22
	Arm	5.80	6.00	7.50	7.50	116
N93H3BM, N93H3OBM		11.50	18.30	22.50	24.00	228
N93H3BMX, N93H3OBMX	Back	1.70	2.00	2.80	4.30	33
	Seat	2.50	4.50	6.30	7.50	50
	Lumbar	1.10	2.00	2.30	3.00	22
	Extreme	2.30	3.80	1.30	4.80	43
	Accent	1.10	2.00	2.30	3.00	22
	Arm	4.40	4.80	6.00	7.00	87
N93H3L, N93H3LL, N93H3OL, N93H3OR, N93H3R, N93H3RR		8.70	15.30	19.30	20.00	172
N93H3LH, N93H3OLH, N93H3ORH, N93H3RH		10.10	16.80	21.00	21.50	201
N93H3LHX, N93H3OLHX, N93H3ORHX, N93H3RHX	Back	1.70	2.00	2.80	4.30	33
	Seat	2.50	4.50	6.30	7.50	50
	Lumbar	1.10	2.00	2.30	3.00	22
	Extreme	2.30	3.80	1.30	4.80	43
	Accent	1.10	2.00	2.30	3.00	22
	Arm	3.00	3.30	4.50	4.50	60
N93H3LLX, N93H3LX, N93H3OLX, N93H3ORX, N93H3RRX, N93H3RX	Back	1.70	2.00	2.80	4.30	33
	Seat	2.50	4.50	6.30	7.50	50
	Lumbar	1.10	2.00	2.30	3.00	22
	Extreme	2.30	3.80	1.30	4.80	43
	Accent	1.10	2.00	2.30	3.00	22
	Arm	1.60	1.80	2.80	3.00	31
N93H3LM, N93H3OLM, N93H3ORM, N93H3RM		9.40	16.00	20.50	21.30	186
N93H3LMX, N93H3OLMX, N93H3ORMX, N93H3RMX	Back	1.70	2.00	2.80	4.30	33
	Seat	2.50	4.50	6.30	7.50	50
	Lumbar	1.10	2.00	2.30	3.00	22
	Extreme	2.30	3.80	1.30	4.80	43
	Accent	1.10	2.00	2.30	3.00	22
	Arm	2.30	2.50	4.00	4.30	45
N93H3M, N93H3OM		7.10	13.50	16.50	17.00	141

COM YARDAGE REQUIREMENTS

COM YARDAGE REQUIREMENTS (54" WIDTH – CUT UP THE ROLL)

MODEL	RAILOADED Contact customer service 800-634-9510 for ydg requirements	NON DIRECTIONAL OR SOLID	1"-4" REPEAT	5"-11" REPEAT	12"-18" REPEAT	COL SQUARE FEET
			4" VERTICAL X 4" HORIZONTAL	11" VERTICAL X 11" HORIZONTAL	18" VERTICAL X 18" HORIZONTAL	
N93H3MX, N93H3OMX	Back	1.70	2.00	2.80	4.30	33
	Seat	2.50	4.50	6.30	7.50	50
	Lumbar	1.10	2.00	2.30	3.00	22
	Extreme	2.30	5.00	6.00	6.50	45
	Accent	1.10	2.00	2.30	3.00	22
N93HALU, N93HARU		3.00	3.30	4.50	4.50	60
N93HBH1MD, N93HBH1MDP, N93HBH1OMD		4.70	7.00	10.00	12.00	93
N93HBH1MDPX, N93HBH1MDX, N93HBH1OMDX	Back	1.20	2.00	2.50	3.50	24
	Seat	2.70	3.80	6.50	8.00	52
	Lumbar	0.90	2.00	2.50	2.50	17
	Accent	1.00	1.30	1.50	2.00	20
N93HBH1MSP		3.30	5.50	7.00	7.50	66
N93HBH1MSPX	Back	1.20	1.50	2.00	2.00	24
	Seat	1.60	2.00	3.50	4.00	31
	Lumbar	0.90	1.00	1.30	1.50	17
	Extreme	1.20	2.00	2.00	2.50	24
	Accent	0.70	0.80	1.00	1.30	13
N93HBH2MD, N93HBH2MDP, N93HBH2OMD		6.90	11.50	15.00	18.00	138
N93HBH2MDPX, N93HBH2MDX, N93HBH2OMDX	Back	1.70	2.50	3.00	5.00	34
	Seat	3.60	6.00	9.00	12.50	72
	Lumbar	1.50	2.80	3.30	4.50	30
	Accent	1.50	2.50	3.00	4.30	29
N93HBH2MSP		5.10	9.00	11.50	11.50	102
N93HBH2MSPX	Back	1.20	1.30	2.50	2.50	24
	Seat	1.90	3.50	4.60	5.50	38
	Lumbar	0.90	1.50	2.00	2.00	17
	Extreme	1.60	3.50	4.00	4.30	31
	Accent	1.00	1.30	1.50	2.00	2.3
N93HC2	Complete	7.86	11.00	18.00	18.50	156.6
N93HC2X	Back	1.39	2.00	3.00	4.00	27.7
	Seat	1.97	2.50	4.50	5.50	39.3
	Lumbar	1.03	1.50	2.50	3.00	20.5
	Extreme	5.75	6.50	7.50	8.50	114.6
	Accent	1.39	2.20	3.00	3.00	27.7
N93HC3	Complete	9.53	13.50	23.00	23.00	189.8
N93HC3X	Back	1.64	2.00	3.50	4.25	32.7
	Seat	2.72	3.25	6.75	7.00	54.2
	Lumbar	1.50	2.00	3.00	3.50	29.9
	Extreme	5.75	7.75	9.50	10.25	114.6
	Accent	1.50	2.50	3.50	3.50	29.9
N93HIN9	Complete	5.78	8.00	10.50	12.00	115.1
N93HIN9X	Back	1.17	1.75	2.00	2.50	23.2
	Seat	1.78	2.50	3.75	5.00	35.4
	Lumbar	1.03	1.50	1.75	2.50	20.5
	Extreme	2.28	3.50	4.00	4.50	45.4
	Accent	1.00	1.50	2.00	2.00	19.9
N93HINR9	Complete	7.11	8.50	11.50	12.75	141.7
N93HINR9X	Back	1.28	1.50	2.75	3.25	25.5
	Seat	2.25	3.00	4.50	6.50	44.8
	Lumbar	1.28	1.75	2.00	2.50	25.5
	Extreme	2.97	3.50	4.00	4.50	59.2
	Accent	1.11	1.50	2.00	2.75	22.1
N93HOU9	Complete	4.11	6.00	8.00	9.00	81.9
N93HOU9X	Back	1.14	1.50	2.00	2.75	22.7
	Seat	2.22	3.00	4.50	5.80	44.3
	Lumbar	0.75	1.00	1.40	1.25	14.9
	Extreme	1.50	1.75	2.10	2.50	29.9
	Accent	0.56	1.00	1.25	1.75	11.1

COM YARDAGE REQUIREMENTS

COM YARDAGE REQUIREMENTS (54" WIDTH – CUT UP THE ROLL)

MODEL	RAILROADED Contact customer service 800-634-9510 for ydg requirements	NON DIRECTIONAL OR SOLID	1"-4" REPEAT	5"-11" REPEAT	12"-18" REPEAT	COL SQUARE FEET
			4" VERTICAL X 4" HORIZONTAL	11" VERTICAL X 11" HORIZONTAL	18" VERTICAL X 18" HORIZONTAL	
N93HOUR9	Complete	4.67	6.00	8.50	9.00	93
N93HOUR9X	Back	1.17	1.50	2.20	3.00	23.2
	Seat	2.78	3.80	4.50	5.50	55.3
	Lumbar	0.81	1.00	1.00	1.80	16
	Extreme	1.22	1.50	2.00	2.50	24.4
	Accent	0.67	0.75	1.50	1.75	13.3
N93HSQ9D	Complete	4.39	6.00	9.00	12.00	87.4
N93HSQ9DX	Back	1.14	1.50	2.00	3.25	22.7
	Seat	1.22	1.75	3.25	3.50	24.4
	Lumbar	0.78	1.00	2.00	2.50	15.5
	Extreme	2.94	3.00	4.00	4.50	58.7
	Accent	0.94	1.25	1.50	2.25	18.8
N93HSQ9L, N93HSQ9R	Complete	4.22	6.00	9.00	12.00	84.1
N93HSQ9LX, N93HSQ9RX	Back	1.14	1.50	2.00	3.25	22.7
	Seat	1.17	1.50	3.00	4.00	23.2
	Lumbar	0.78	1.00	2.00	2.50	15.5
	Extreme	2.94	3.00	4.00	4.50	58.7
	Accent	0.94	1.25	1.50	2.25	18.8
N93HTL2B, N93HTL2BB, N93HTL2BL, N93HTL2BR, N93HTW2B, N93HTW2BB, N93HTW2BL, N93HTW2BR		7.10	10.70	14.10	15.00	141
N93HTL2BBX, N93HTL2BLX, N93HTL2BRX, N93HTL2BX, N93HTW2BBX, N93HTW2BLX, N93HTW2BRX, N93HTW2BX	Back	1.20	1.30	2.50	2.50	24
	Seat	1.90	3.50	4.60	5.50	38
	Lumbar	0.90	1.50	2.00	2.00	17
	Extreme	1.20	1.80	2.80	3.00	24
	Accent	1.00	1.30	1.50	2.00	19
Arm	2.90	3.40	4.60	5.00	56	
N93HTL2BH, N93HTW2BH		10.10	13.30	17.00	17.50	201
N93HTL2BHX, N93HTW2BHX	Back	1.20	1.30	2.50	2.50	24
	Seat	1.90	3.50	4.60	5.50	38
	Lumbar	0.90	1.50	2.00	2.00	17
	Extreme	1.20	1.80	2.80	3.00	24
	Accent	1.00	1.30	1.50	2.00	19
Arm	5.80	6.00	7.50	7.50	116	
N93HTL2BM, N93HTW2BM		9.70	12.00	15.50	17.00	172
N93HTL2BMX, N93HTW2BMX	Back	1.20	1.30	2.50	2.50	24
	Seat	1.90	3.50	4.60	5.50	38
	Lumbar	0.90	1.50	2.00	2.00	17
	Extreme	1.20	1.80	2.80	3.00	24
	Accent	1.00	1.30	1.50	2.00	19
Arm	4.40	4.80	6.00	7.00	87	
N93HTL2L, N93HTL2LL, N93HTL2R, N93HTL2RR, N93HTW2L, N93HTW2LL, N93HTW2R, N93HTW2RR		5.90	9.00	12.30	13.00	116
N93HTL2LH, N93HTL2RH, N93HTW2LH, N93HTW2RH		7.30	10.50	14.00	14.50	145
N93HTL2LHX, N93HTL2RHX, N93HTW2LHX, N93HTW2RHX	Back	1.20	1.30	2.50	2.50	24
	Seat	1.90	3.50	4.60	5.50	38
	Lumbar	0.90	1.50	2.00	2.00	17
	Extreme	1.20	1.80	2.80	3.00	24
	Accent	1.00	1.30	1.50	2.00	19
Arm	3.00	3.30	4.50	4.50	60	
N93HTL2LLX, N93HTL2LX, N93HTL2RRX, N93HTL2RX, N93HTW2LLX, N93HTW2LX, N93HTW2RRX, N93HTW2RX	Back	1.20	1.30	2.50	2.50	24
	Seat	1.90	3.50	4.60	5.50	38
	Lumbar	0.90	1.50	2.00	2.00	17
	Extreme	1.20	1.80	2.80	3.00	24
	Accent	1.00	1.30	1.50	2.00	19
Arm	1.60	1.80	2.80	3.00	31	

COM YARDAGE REQUIREMENTS

COM YARDAGE REQUIREMENTS (54" WIDTH – CUT UP THE ROLL)

MODEL	RAILOADED Contact customer service 800-634-9510 for ydg requirements	NON DIRECTIONAL OR SOLID	1"-4" REPEAT	5"-11" REPEAT	12"-18" REPEAT	COL SQUARE FEET	
			4" VERTICAL X 4" HORIZONTAL	11" VERTICAL X 11" HORIZONTAL	18" VERTICAL X 18" HORIZONTAL		
N93HTL2LM, N93HTL2RM, N93HTW2LM, N93HTW2RM			6.50	9.80	13.50	14.30	130
N93HTL2LMX, N93HTL2RMX, N93HTW2LMX, N93HTW2RMX	Back		1.20	1.30	2.50	2.50	24
	Seat		1.90	3.50	4.60	5.50	38
	Lumbar		0.90	1.50	2.00	2.00	17
	Extreme		1.20	1.80	2.80	3.00	24
	Accent		1.00	1.30	1.50	2.00	19
	Arm		2.30	2.50	4.00	4.30	45
N93HTL2M, N93HTW2M			4.30	7.30	9.50	10.00	85
N93HTL2MX, N93HTW2MX	Back		1.20	1.30	2.50	2.50	24
	Seat		1.90	3.50	4.60	5.50	38
	Lumbar		0.90	1.50	2.00	2.00	17
	Extreme		1.20	1.80	2.80	3.00	24
	Accent		1.00	1.30	1.50	2.00	19
N93HTL3B, N93HTL3BB, N93HTL3BL, N93HTL3BR, N93HTW3B, N93HTW3BB, N93HTW3BL, N93HTW3BR			8.60	14.40	18.60	21.00	171
N93HTL3BBX, N93HTL3BLX, N93HTL3BRX, N93HTL3BX, N93HTW3BBX, N93HTW3BLX, N93HTW3BRX, N93HTW3BX	Back		1.70	2.00	2.80	4.30	33
	Seat		2.50	4.50	6.30	7.50	50
	Lumbar		1.10	2.00	2.30	3.00	22
	Extreme		1.60	2.30	3.00	4.50	31
	Accent		1.10	2.00	2.30	3.00	22
	Arm		2.90	3.40	4.60	5.00	56
N93HTL3BH, N93HTW3BH			11.60	17.00	21.50	23.50	231
N93HTL3BHX, N93HTW3BHX	Back		1.70	2.00	2.80	4.30	33
	Seat		2.50	4.50	6.30	7.50	50
	Lumbar		1.10	2.00	2.30	3.00	22
	Extreme		1.60	2.30	3.00	4.50	31
	Accent		1.10	2.00	2.30	3.00	22
	Arm		5.80	6.00	7.50	7.50	116
N93HTL3BM, N93HTW3BM			10.20	15.80	20.00	23.00	202
N93HTL3BMX, N93HTW3BMX	Back		1.70	2.00	2.80	4.30	33
	Seat		2.50	4.50	6.30	7.50	50
	Lumbar		1.10	2.00	2.30	3.00	22
	Extreme		1.60	2.30	3.00	4.50	31
	Accent		1.10	2.00	2.30	3.00	22
	Arm		4.40	4.80	6.00	7.00	87
N93HTL3L, N93HTL3LL, N93HTL3R, N93HTL3RR, N93HTW3L, N93HTW3LL, N93HTW3R, N93HTW3RR			7.40	12.80	16.80	19.00	146
N93HTL3LH, N93HTL3RH, N93HTW3LH, N93HTW3RH			8.80	14.30	18.50	20.50	175
N93HTL3LHX, N93HTL3RHX, N93HTW3LHX, N93HTW3RHX	Back		1.70	2.00	2.80	4.30	33
	Seat		2.50	4.50	6.30	7.50	50
	Lumbar		1.10	2.00	2.30	3.00	22
	Extreme		1.60	2.30	3.00	4.50	31
	Accent		1.10	2.00	2.30	3.00	22
	Arm		3.00	3.30	4.50	4.50	60
N93HTL3LLX, N93HTL3LX, N93HTL3RRX, N93HTL3RX, N93HTW3LLX, N93HTW3LX, N93HTW3RRX, N93HTW3RX	Back		1.70	2.00	2.80	4.30	33
	Seat		2.50	4.50	6.30	7.50	50
	Lumbar		1.10	2.00	2.30	3.00	22
	Extreme		1.60	2.30	3.00	4.50	31
	Accent		1.10	2.00	2.30	3.00	22
	Arm		1.60	1.80	2.80	3.00	31
N93HTL3LM, N93HTL3RM, N93HTW3LM, N93HTW3RM			8.00	13.50	18.00	20.30	160

FRINGE

COM YARDAGE REQUIREMENTS

COM YARDAGE REQUIREMENTS (54" WIDTH – CUT UP THE ROLL)

MODEL	RAILROADED Contact customer service 800-634-9510 for ydg requirements	NON DIRECTIONAL OR SOLID	1"-4" REPEAT	5"-11" REPEAT	12"-18" REPEAT	COL SQUARE FEET
			4" VERTICAL X 4" HORIZONTAL	11" VERTICAL X 11" HORIZONTAL	18" VERTICAL X 18" HORIZONTAL	
N93HTL3LMX, N93HTL3RMX, N93HTW3LMX, N93HTW3RMX	Back	1.70	2.00	2.80	4.30	33
	Seat	2.50	4.50	6.30	7.50	50
	Lumbar	1.10	2.00	2.30	3.00	22
	Extreme	1.60	2.30	3.00	4.50	31
	Accent	1.10	2.00	2.30	3.00	22
	Arm	2.30	2.50	4.00	4.30	45
N93HTL3M, N93HTW3M		5.80	11.00	14.00	16.00	115
N93HTL3MX, N93HTW3MX	Back	1.70	2.00	2.80	4.30	33
	Seat	2.50	4.50	6.30	7.50	50
	Lumbar	1.10	2.00	2.30	3.00	22
	Extreme	1.60	2.30	3.00	4.50	31
	Accent	1.10	2.00	2.30	3.00	22
	Complete		5.97	8.00	14.00	15.00
N93HTLC2, N93HTWC2	Back	1.39	2.00	2.50	3.75	27.7
	Seat	1.97	2.50	4.50	5.50	39.3
	Lumbar	1.03	1.50	2.25	2.75	20.5
	Extreme	2.19	2.75	4.00	6.00	43.7
	Accent	1.39	2.50	2.75	3.00	27.7
	Complete		7.42	10.50	18.50	18.50
N93HTLC3, N93HTWC3	Back	1.64	2.00	3.50	4.25	32.7
	Seat	2.72	3.25	6.75	7.00	54.2
	Lumbar	1.50	2.00	3.00	3.50	29.9
	Extreme	2.19	3.25	5.00	5.75	43.7
	Accent	1.50	2.50	3.50	3.50	29.9
	Complete		4.69	7.00	9.50	10.50
N93HTLIN9, N93HTWIN9	Back	1.17	1.75	2.00	2.50	23.2
	Seat	1.78	2.50	3.75	5.00	35.4
	Lumbar	1.03	1.50	1.75	2.50	20.5
	Extreme	1.17	2.00	2.75	3.75	23.2
	Accent	1.00	1.50	2.00	2.00	19.9
	Complete		3.53	5.00	7.00	12.00
N93HTLSQ9D, N93HTWSQ9D	Back	1.14	1.50	2.00	3.25	22.7
	Seat	1.22	1.75	3.25	3.50	24.4
	Lumbar	0.78	1.00	2.00	2.50	15.5
	Extreme	1.25	1.50	2.25	2.50	24.9
	Accent	0.94	1.25	1.50	2.25	18.8
	Complete		3.47	5.00	7.00	12.00
N93HTLSQ9L, N93HTLSQ9R, N93HTWSQ9L, N93HTWSQ9R	Back	1.14	1.50	2.00	3.25	22.7
	Seat	1.17	1.50	3.00	4.00	23.2
	Lumbar	0.78	1.00	2.00	2.50	15.5
	Extreme	1.25	1.50	2.25	2.50	24.9
	Accent	0.94	1.25	1.50	2.25	18.8
	Complete		7.90	12.40	16.10	16.50
N93HTU2B, N93HTU2BB, N93HTU2BL, N93HTU2BR	Back	1.20	1.30	2.50	2.50	24
	Seat	1.90	3.50	4.60	5.50	38
	Lumbar	0.90	1.50	2.00	2.00	17
	Extreme	1.60	3.50	4.00	4.30	31
	Accent	1.00	1.30	1.50	2.00	19
	Arm	2.90	3.40	4.60	5.00	56
N93HTU2BH		10.90	15.00	19.00	19.00	218
N93HTU2BHX	Back	1.20	1.30	2.50	2.50	24
	Seat	1.90	3.50	4.60	5.50	38
	Lumbar	0.90	1.50	2.00	2.00	17
	Extreme	1.60	3.50	4.00	4.30	31
	Accent	1.00	1.30	1.50	2.00	19
	Arm	5.80	6.00	7.50	7.50	116
N93HTU2BM		9.50	13.80	17.50	18.50	189

COM YARDAGE REQUIREMENTS

COM YARDAGE REQUIREMENTS (54" WIDTH – CUT UP THE ROLL)

MODEL	RAILOADED Contact customer service 800-634-9510 for ydg requirements	NON DIRECTIONAL OR SOLID	1"-4" REPEAT	5"-11" REPEAT	12"-18" REPEAT	COL SQUARE FEET
			4" VERTICAL X 4" HORIZONTAL	11" VERTICAL X 11" HORIZONTAL	18" VERTICAL X 18" HORIZONTAL	
N93HTU2BMX	Back	1.20	1.30	2.50	2.50	24
	Seat	1.90	3.50	4.60	5.50	38
	Lumbar	0.90	1.50	2.00	2.00	17
	Extreme	1.60	3.50	4.00	4.30	31
	Accent	1.00	1.30	1.50	2.00	19
	Arm	4.40	4.80	6.00	7.00	87
N93HTU2L, N93HTU2LL, N93HTU2R, N93HTU2RR		6.70	10.80	14.30	14.50	133
N93HTU2LH, N93HTU2RH		8.10	12.30	16.00	16.00	162
N93HTU2LHX, N93HTU2RHX	Back	1.20	1.30	2.50	2.50	24
	Seat	1.90	3.50	4.60	5.50	38
	Lumbar	0.90	1.50	2.00	2.00	17
	Extreme	1.60	3.50	4.00	4.30	31
	Accent	1.00	1.30	1.50	2.00	19
	Arm	3.00	3.30	4.50	4.50	60
N93HTU2LLX, N93HTU2LX, N93HTU2RRX, N93HTU2RX	Back	1.20	1.30	2.50	2.50	24
	Seat	1.90	3.50	4.60	5.50	38
	Lumbar	0.90	1.50	2.00	2.00	17
	Extreme	1.60	3.50	4.00	4.30	31
	Accent	1.00	1.30	1.50	2.00	19
	Arm	1.60	1.80	2.80	3.00	31
N93HTU2LM, N93HTU2RM		7.40	11.50	15.50	15.80	147
N93HTU2LMX, N93HTU2RMX	Back	1.20	1.30	2.50	2.50	24
	Seat	1.90	3.50	4.60	5.50	38
	Lumbar	0.90	1.50	2.00	2.00	17
	Extreme	1.60	3.50	4.00	4.30	31
	Accent	1.00	1.30	1.50	2.00	19
	Arm	2.30	2.50	4.00	4.30	45
N93HTU2M		5.10	9.00	11.50	11.50	102
N93HTU2MX	Back	1.20	1.30	2.50	2.50	24
	Seat	1.90	3.50	4.60	5.50	38
	Lumbar	0.90	1.50	2.00	2.00	17
	Extreme	1.60	3.50	4.00	4.30	31
	Accent	1.00	1.30	1.50	2.00	19
N93HTU3B, N93HTU3BB, N93HTU3BL, N93HTU3BR		9.90	16.90	21.10	22.00	197
N93HTU3BBX, N93HTU3BLX, N93HTU3BRX, N93HTU3BX	Back	1.70	2.00	2.80	4.30	33
	Seat	2.50	4.50	6.30	7.50	50
	Lumbar	1.10	2.00	2.30	3.00	22
	Extreme	2.30	3.80	1.30	4.80	43
	Accent	1.10	2.00	2.30	3.00	22
	Arm	2.90	3.40	4.60	5.00	56
N93HTU3BH		12.90	19.50	24.00	24.50	257
N93HTU3BHX	Back	1.70	2.00	2.80	4.30	33
	Seat	2.50	4.50	6.30	7.50	50
	Lumbar	1.10	2.00	2.30	3.00	22
	Extreme	2.30	3.80	1.30	4.80	43
	Accent	1.10	2.00	2.30	3.00	22
	Arm	5.80	6.00	7.50	7.50	116
N93HTU3BM		11.50	18.30	22.50	24.00	228
N93HTU3BMX	Back	1.70	2.00	2.80	4.30	33
	Seat	2.50	4.50	6.30	7.50	50
	Lumbar	1.10	2.00	2.30	3.00	22
	Extreme	2.30	3.80	1.30	4.80	43
	Accent	1.10	2.00	2.30	3.00	22
	Arm	4.40	4.80	6.00	7.00	87
N93HTU3L, N93HTU3LL, N93HTU3R, N93HTU3RR		8.70	15.30	19.30	20.00	172
N93HTU3LH, N93HTU3RH		10.10	16.80	21.00	21.50	201

FRINGE

COM YARDAGE REQUIREMENTS

COM YARDAGE REQUIREMENTS (54" WIDTH – CUT UP THE ROLL)

MODEL	RAILROADED Contact customer service 800-634-9510 for ydg requirements	NON DIRECTIONAL OR SOLID	1"-4" REPEAT	5"-11" REPEAT	12"-18" REPEAT	COL SQUARE FEET
			4" VERTICAL X 4" HORIZONTAL	11" VERTICAL X 11" HORIZONTAL	18" VERTICAL X 18" HORIZONTAL	
N93HTU3LHX, N93HTU3RHX	Back	1.70	2.00	2.80	4.30	33
	Seat	2.50	4.50	6.30	7.50	50
	Lumbar	1.10	2.00	2.30	3.00	22
	Extreme	2.30	3.80	1.30	4.80	43
	Accent	1.10	2.00	2.30	3.00	22
	Arm	3.00	3.30	4.50	4.50	60
N93HTU3LLX, N93HTU3LX, N93HTU3RRX, N93HTU3RX	Back	1.70	2.00	2.80	4.30	33
	Seat	2.50	4.50	6.30	7.50	50
	Lumbar	1.10	2.00	2.30	3.00	22
	Extreme	2.30	3.80	1.30	4.80	43
	Accent	1.10	2.00	2.30	3.00	22
	Arm	1.60	1.80	2.80	3.00	31
N93HTU3LM, N93HTU3RM		9.40	16.00	20.50	21.30	186
N93HTU3LMX, N93HTU3RMX	Back	1.70	2.00	2.80	4.30	33
	Seat	2.50	4.50	6.30	7.50	50
	Lumbar	1.10	2.00	2.30	3.00	22
	Extreme	2.30	3.80	1.30	4.80	43
	Accent	1.10	2.00	2.30	3.00	22
	Arm	2.30	2.50	4.00	4.30	45
N93HTU3M		7.10	13.50	16.50	17.00	141
N93HTU3MX	Back	1.70	2.00	2.80	4.30	33
	Seat	2.50	4.50	6.30	7.50	50
	Lumbar	1.10	2.00	2.30	3.00	22
	Extreme	2.30	3.80	1.30	4.80	43
	Accent	1.10	2.00	2.30	3.00	22
	Complete	7.86	11.00	18.00	18.50	156.6
N93HTUC2X	Back	1.39	2.00	3.00	4.00	27.7
	Seat	1.97	2.50	4.50	5.50	39.3
	Lumbar	1.03	1.50	2.50	3.00	20.5
	Extreme	5.75	6.50	7.50	8.50	114.6
	Accent	1.39	2.20	3.00	3.00	27.7
	Complete	9.53	13.50	23.00	23.00	189.8
N93HTUC3X	Back	1.64	2.00	3.50	4.25	32.7
	Seat	2.72	3.25	6.75	7.00	54.2
	Lumbar	1.50	2.00	3.00	3.50	29.9
	Extreme	5.75	7.75	9.50	10.25	114.6
	Accent	1.50	2.50	3.50	3.50	29.9
	Complete	5.78	8.00	10.50	12.00	115.1
N93HTUIN9X	Back	1.17	1.75	2.00	2.50	23.2
	Seat	1.78	2.50	3.75	5.00	35.4
	Lumbar	1.03	1.50	1.75	2.50	20.5
	Extreme	2.28	3.50	4.00	4.50	45.4
	Accent	1.00	1.50	2.00	2.00	19.9
	Complete	7.11	8.50	11.50	12.75	141.7
N93HTUINR9X	Back	1.28	1.50	2.75	3.25	25.5
	Seat	2.25	3.00	4.50	6.50	44.8
	Lumbar	1.28	1.75	2.00	2.50	25.5
	Extreme	2.97	3.50	4.00	4.50	59.2
	Accent	1.11	1.50	2.00	2.75	22.1
	Complete	4.39	6.00	9.00	12.00	87.4
N93HTUSQ9DX	Back	1.14	1.50	2.00	3.25	22.7
	Seat	1.22	1.75	3.25	3.50	24.4
	Lumbar	0.78	1.00	2.00	2.50	15.5
	Extreme	2.94	3.00	4.00	4.50	58.7
	Accent	0.94	1.25	1.50	2.25	18.8
	Complete	4.22	6.00	9.00	12.00	84.1
N93HTUSQ9LX, N93HTUSQ9RX	Back	1.14	1.50	2.00	3.25	22.7
	Seat	1.17	1.50	3.00	4.00	23.2
	Lumbar	0.78	1.00	2.00	2.50	15.5
	Extreme	2.94	3.00	4.00	4.50	58.7
	Accent	0.94	1.25	1.50	2.25	18.8
	Complete					

COM YARDAGE REQUIREMENTS

COM YARDAGE REQUIREMENTS (54" WIDTH – CUT UP THE ROLL)

MODEL	RAILOADED Contact customer service 800-634-9510 for ydg requirements	NON DIRECTIONAL OR SOLID	1"-4" REPEAT	5"-11" REPEAT	12"-18" REPEAT	COL SQUARE FEET	
			4" VERTICAL X 4" HORIZONTAL	11" VERTICAL X 11" HORIZONTAL	18" VERTICAL X 18" HORIZONTAL		
N93M1B, N93M1BL, N93M1BR, N93M1OB			5.90	7.90	10.60	11.50	117
N93M1BLX, N93M1BRX, N93M1BX, N93M1OBX	Back		1.20	1.50	2.00	2.00	24
	Seat		1.60	2.00	3.50	4.00	31
	Lumbar		0.90	1.00	1.30	1.50	17
	Extreme		1.20	1.50	1.80	2.00	24
	Arm		2.90	3.40	4.60	5.00	56
N93M1BM, N93M1OBM			7.40	9.30	12.00	13.50	148
N93M1BMX, N93M1OBMX	Back		1.20	1.50	2.00	2.00	24
	Seat		1.60	2.00	3.50	4.00	31
	Lumbar		0.90	1.00	1.30	1.50	17
	Extreme		1.20	1.50	1.80	2.00	24
	Arm		4.40	4.80	6.00	7.00	87
N93M1L, N93M1LL, N93M1OL, N93M1OR, N93M1R, N93M1RR			4.70	6.30	8.80	9.50	92
N93M1LM, N93M1OLM, N93M1ORM, N93M1RM			5.40	7.00	10.00	10.80	106
N93M1LMX, N93M1OLMX, N93M1ORMX, N93M1RMX	Back		1.20	1.50	2.00	2.00	24
	Seat		1.60	2.00	3.50	4.00	31
	Lumbar		0.90	1.00	1.30	1.50	17
	Extreme		1.20	1.50	1.80	2.00	24
	Arm		2.30	2.50	4.00	4.30	45
N93M1M, N93M1OM			3.10	4.50	6.00	6.50	61
N93M1MX, N93M1OMX	Back		1.20	1.50	2.00	2.00	24
	Seat		1.60	2.00	3.50	4.00	31
	Lumbar		0.90	1.00	1.30	1.50	17
	Extreme		1.20	1.50	1.80	2.00	24
N93M1RX	Back		1.20	1.50	2.00	2.00	24
	Seat		1.60	2.00	3.50	4.00	31
	Lumbar		0.90	1.00	1.30	1.50	17
	Extreme		1.20	1.50	1.80	2.00	24
	Arm		1.60	1.80	2.80	3.00	31
N93M2B, N93M2BB, N93M2BL, N93M2BR, N93M2OB			7.20	10.80	14.10	15.50	143
N93M2BBX, N93M2BLX, N93M2BRX, N93M2BX, N93M2OBX	Back		1.20	1.30	2.50	2.50	24
	Seat		1.90	3.50	4.60	5.50	38
	Lumbar		0.90	1.50	2.00	2.00	17
	Extreme		1.20	2.50	2.90	3.30	24
	Arm		2.90	3.40	4.60	5.00	56
N93M2BM, N93M2OBM			8.80	12.20	17.00	18.00	174
N93M2BMX, N93M2OBMX	Back		1.20	1.30	2.50	2.50	24
	Seat		1.90	3.50	4.60	5.50	38
	Lumbar		0.90	1.50	2.00	2.00	17
	Extreme		1.20	2.50	2.90	3.30	24
	Arm		4.40	4.80	6.00	7.00	87
N93M2L, N93M2LL, N93M2OL, N93M2OR, N93M2R, N93M2RR			6.00	9.20	12.30	13.50	118
N93M2LLX, N93M2LX, N93M2OLX, N93M2ORX, N93M2RRX, N93M2RX	Back		1.20	1.30	2.50	2.50	24
	Seat		1.90	3.50	4.60	5.50	38
	Lumbar		0.90	1.50	2.00	2.00	17
	Extreme		1.20	2.50	2.90	3.30	24
	Arm		1.60	1.80	2.80	3.00	31
N93M2LM, N93M2OLM, N93M2ORM, N93M2RM			6.70	9.90	13.50	14.80	132
N93M2LMX, N93M2OLMX, N93M2ORMX, N93M2RMX	Back		1.20	1.30	2.50	2.50	24
	Seat		1.90	3.50	4.60	5.50	38
	Lumbar		0.90	1.50	2.00	2.00	17
	Extreme		1.20	2.50	2.90	3.30	24
	Arm		2.30	2.50	4.00	4.30	45
N93M2M, N93M2OM			4.40	7.40	9.50	10.50	87

COM YARDAGE REQUIREMENTS

COM YARDAGE REQUIREMENTS (54" WIDTH – CUT UP THE ROLL)

MODEL	RAILROADED Contact customer service 800-634-9510 for ydg requirements	NON DIRECTIONAL OR SOLID	1"-4" REPEAT	5"-11" REPEAT	12"-18" REPEAT	COL SQUARE FEET
			4" VERTICAL X 4" HORIZONTAL	11" VERTICAL X 11" HORIZONTAL	18" VERTICAL X 18" HORIZONTAL	
N93M2MX, N93M2OMX	Back	1.20	1.30	2.50	2.50	24
	Seat	1.90	3.50	4.60	5.50	38
	Lumbar	0.90	1.50	2.00	2.00	17
	Extreme	1.20	2.50	2.90	3.30	24
N93M3B, N93M3BB, N93M3BL, N93M3BR, N93M3OB		8.90	14.40	18.10	20.00	176
N93M3BBX, N93M3BLX, N93M3BRX, N93M3BX, N93M3OBX	Back	1.70	2.00	2.80	4.30	33
	Seat	2.50	4.50	6.30	7.50	50
	Lumbar	1.10	2.00	2.30	3.00	22
	Extreme	2.30	3.80	1.30	4.80	43
	Arm	2.90	3.40	4.60	5.00	56
N93M3BM, N93M3OBM		10.40	15.80	19.50	22.00	207
N93M3BMX, N93M3OBMX	Back	1.70	2.00	2.80	4.30	33
	Seat	2.50	4.50	6.30	7.50	50
	Lumbar	1.10	2.00	2.30	3.00	22
	Extreme	2.30	3.80	1.30	4.80	43
	Arm	4.40	4.80	6.00	7.00	87
N93M3L, N93M3LL, N93M3OL, N93M3OR, N93M3R, N93M3RR		7.60	12.80	16.30	18.00	151
N93M3LLX, N93M3LX, N93M3OLX, N93M3ORX, N93M3RRX, N93M3RX	Back	1.70	2.00	2.80	4.30	33
	Seat	2.50	4.50	6.30	7.50	50
	Lumbar	1.10	2.00	2.30	3.00	22
	Extreme	2.30	3.80	1.30	4.80	43
	Arm	1.60	1.80	2.80	3.00	31
N93M3LM, N93M3OLM, N93M3ORM, N93M3RM		8.30	13.50	17.50	19.30	165
N93M3LMX, N93M3OLMX, N93M3ORMX, N93M3RMX	Back	1.70	2.00	2.80	4.30	33
	Seat	2.50	4.50	6.30	7.50	50
	Lumbar	1.10	2.00	2.30	3.00	22
	Extreme	2.30	3.80	1.30	4.80	43
	Arm	2.30	2.50	4.00	4.30	45
N93M3M, N93M3OM		6.00	11.00	13.50	15.00	120
N93M3MX, N93M3OMX	Back	1.70	2.00	2.80	4.30	33
	Seat	2.50	4.50	6.30	7.50	50
	Lumbar	1.10	2.00	2.30	3.00	22
	Extreme	2.30	3.80	4.30	4.80	45
N93MALU, N93MARU		2.30	2.50	4.00	4.30	45
N93MBH1MD, N93MBH1MDP, N93MBH1OMD		4.30	6.50	9.50	12.00	85
N93MBH1MDPX, N93MBH1MDX, N93MBH1OMDX	Back	1.20	2.00	2.50	3.50	24
	Seat	2.70	3.80	6.50	8.00	52
	Lumbar	0.90	2.00	2.50	2.50	17
N93MBH1MSP		3.10	4.50	6.00	6.50	61
N93MBH1MSPX	Back	1.20	1.50	2.00	2.00	24
	Seat	1.60	2.00	3.50	4.00	31
	Lumbar	0.90	1.00	1.30	1.50	17
	Extreme	1.20	1.50	1.80	2.00	24
N93MBH2MD, N93MBH2MDP, N93MBH2OMD		6.00	10.30	14.00	20.50	120
N93MBH2MDPX, N93MBH2MDX, N93MBH2OMDX	Back	1.70	2.50	3.00	5.00	34
	Seat	3.60	6.00	9.00	12.50	72
	Lumbar	1.50	2.80	3.30	4.50	30
N93MBH2MSP		4.40	7.40	9.50	10.50	87
N93MBH2MSPX	Back	1.20	1.30	2.50	2.50	24
	Seat	1.90	3.50	4.60	5.50	38
	Lumbar	0.90	1.50	2.00	2.00	17
	Extreme	1.20	2.50	2.90	3.30	24
N93MC2		6.00	8.00	12.75	14.50	119.5

COM YARDAGE REQUIREMENTS

COM YARDAGE REQUIREMENTS (54" WIDTH – CUT UP THE ROLL)

MODEL	RAILROADED Contact customer service 800-634-9510 for ydg requirements	NON DIRECTIONAL OR SOLID	1"-4" REPEAT	5"-11" REPEAT	12"-18" REPEAT	COL SQUARE FEET
			4" VERTICAL X 4" HORIZONTAL	11" VERTICAL X 11" HORIZONTAL	18" VERTICAL X 18" HORIZONTAL	
N93MC2X	Back	1.67	2.25	3.00	5.25	33.2
	Seat	1.97	2.50	4.50	5.50	39.3
	Lumbar	1.03	1.50	2.25	2.75	20.5
	Extreme	4.25	4.75	5.00	6.00	84.7
N93MC3	Complete	7.69	10.00	17.25	17.25	153.3
N93MC3X	Back	2.08	2.50	3.50	5.50	41.5
	Seat	2.72	3.25	6.75	7.00	54.2
	Lumbar	1.50	2.00	3.00	3.50	29.9
	Extreme	4.25	6.00	6.50	7.75	84.7
N93MIN9	Complete	4.83	6.50	8.50	10.00	96.3
N93MIN9X	Back	1.17	2.00	2.75	2.75	23.2
	Seat	1.78	2.50	3.75	5.00	35.4
	Lumbar	1.03	1.50	1.75	2.50	20.5
	Extreme	2.17	2.50	2.75	3.25	43.2
N93MINR9	Complete	5.72	7.00	9.25	11.25	114
N93MINR9SL, N93MINR9SW	Complete	6.25	8.00	10.00	12.00	124.5
N93MINR9SLX, N93MINR9SWX	Back	1.94	3.00	3.50	3.50	38.7
	Seat	2.22	3.00	4.50	5.50	44.3
	Lumbar	1.25	1.75	2.00	2.50	24.9
	Extreme	2.19	2.50	3.00	3.50	43.7
N93MINR9X	Back	1.28	2.00	2.75	3.00	25.5
	Seat	2.25	3.00	4.50	6.50	44.8
	Lumbar	1.28	1.75	2.00	2.50	25.5
	Extreme	2.25	2.50	2.75	3.50	44.8
N93MOU9	Complete	3.72	5.50	7.00	8.50	74.2
N93MOU9X	Back	1.14	1.50	2.00	2.50	22.7
	Seat	2.22	3.00	4.50	5.80	44.3
	Lumbar	0.75	1.00	1.00	1.25	14.9
	Extreme	1.14	1.50	1.70	2.00	22.7
N93MOUR9	Complete	4.36	5.50	7.50	8.30	86.9
N93MOUR9X	Back	1.17	1.50	2.20	3.00	23.2
	Seat	2.78	3.80	4.50	5.50	55.3
	Lumbar	0.81	1.00	1.00	1.80	16
	Extreme	1.22	1.50	1.75	1.75	24.4
N93MSQ9D	Complete	3.61	5.00	7.00	10.50	71.9
N93MSQ9DX	Back	1.17	1.50	2.00	3.25	23.2
	Seat	1.22	1.75	3.25	3.50	24.4
	Lumbar	0.78	1.00	2.00	2.50	15.5
	Extreme	2.17	2.50	2.75	3.25	43.2
N93MSQ9L, N93MSQ9R	Complete	3.61	4.50	7.00	10.50	71.9
N93MSQ9LX	Back	1.17	1.50	2.00	3.50	23.2
	Seat	1.17	1.50	3.00	4.00	23.2
	Lumbar	0.78	1.00	2.00	2.50	15.5
	Extreme	2.17	2.50	3.00	3.25	43.2
N93MTL2B, N93MTL2BB, N93MTL2BL, N93MTL2BR, N93MTW2B, N93MTW2BB, N93MTW2BL, N93MTW2BR		6.30	9.20	12.20	13.50	126
N93MTL2BBX, N93MTL2BLX, N93MTL2BRX, N93MTL2BX, N93MTW2BBX, N93MTW2BLX, N93MTW2BRX, N93MTW2BX	Back	1.20	1.30	2.50	2.50	24
	Seat	1.90	3.50	4.60	5.50	38
	Lumbar	0.90	1.50	2.00	2.00	17
	Extreme	1.20	2.50	2.90	3.30	24
	Arm	2.90	3.40	4.60	5.00	56
N93MTL2BM, N93MTW2BM		7.90	10.50	13.60	15.50	157
N93MTL2BMX, N93MTW2BMX	Back	1.20	1.30	2.50	2.50	24
	Seat	1.90	3.50	4.60	5.50	38
	Lumbar	0.90	1.50	2.00	2.00	17
	Extreme	1.20	2.50	2.90	3.30	24
	Arm	4.40	4.80	6.00	7.00	87

COM YARDAGE REQUIREMENTS

COM YARDAGE REQUIREMENTS (54" WIDTH – CUT UP THE ROLL)

MODEL	RAILROADED Contact customer service 800-634-9510 for ydg requirements	NON DIRECTIONAL OR SOLID	1"-4" REPEAT	5"-11" REPEAT	12"-18" REPEAT	COL SQUARE FEET
			4" VERTICAL X 4" HORIZONTAL	11" VERTICAL X 11" HORIZONTAL	18" VERTICAL X 18" HORIZONTAL	
N93MTL2L, N93MTL2LL, N93MTL2R, N93MTL2RR, N93MTW2L, N93MTW2LL, N93MTW2R, N93MTW2RR		5.10	7.50	10.40	11.50	101
N93MTL2LLX, N93MTL2LX, N93MTL2RRX, N93MTL2RX, N93MTW2LLX, N93MTW2LX, N93MTW2RRX, N93MTW2RX	Back Seat Lumbar Extreme Arm	1.20 1.90 0.90 1.20 1.60	1.30 3.50 1.50 2.50 1.80	2.50 4.60 2.00 2.90 2.80	2.50 5.50 2.00 3.30 3.00	24 38 17 24 31
N93MTL2LM, N93MTL2RM, N93MTW2LM, N93MTW2RM		5.80	8.30	11.60	12.80	115
N93MTL2LMX, N93MTL2RMX, N93MTW2LMX, N93MTW2RMX	Back Seat Lumbar Extreme Arm	1.20 1.90 0.90 1.20 2.30	1.30 3.50 1.50 2.50 2.50	2.50 4.60 2.00 2.90 4.00	2.50 5.50 2.00 3.30 4.30	24 38 17 24 45
N93MTL2M, N93MTW2M		3.50	5.80	7.60	8.50	70
N93MTL2MX, N93MTW2MX	Back Seat Lumbar Extreme	1.20 1.90 0.90 1.20	1.30 3.50 1.50 1.80	2.50 4.60 2.00 2.00	2.50 5.50 2.00 2.30	24 38 17 24
N93MTL3B, N93MTL3BB, N93MTL3BL, N93MTL3BR, N93MTW3B, N93MTW3BB, N93MTW3BL, N93MTW3BR		7.50	11.90	15.60	18.00	149
N93MTL3BBX, N93MTL3BLX, N93MTL3BRX, N93MTL3BX, N93MTW3BBX, N93MTW3BLX, N93MTW3BRX, N93MTW3BX	Back Seat Lumbar Extreme Arm	1.70 2.50 1.10 1.20 2.90	2.00 4.50 2.00 1.80 3.40	2.80 6.30 2.30 2.00 4.60	4.30 7.50 3.00 3.00 5.00	33 50 22 24 56
N93MTL3BM, N93MTW3BM		9.00	13.30	17.00	20.00	180
N93MTL3BMX, N93MTW3BMX	Back Seat Lumbar Extreme Arm	1.70 2.50 1.10 1.20 4.40	2.00 4.50 2.00 1.80 4.80	2.80 6.30 2.30 2.00 6.00	4.30 7.50 3.00 3.00 7.00	33 50 22 24 87
N93MTL3L, N93MTL3LL, N93MTL3R, N93MTL3RR, N93MTW3L, N93MTW3LL, N93MTW3R, N93MTW3RR		6.20	10.30	13.80	16.00	124
N93MTL3LLX, N93MTL3LX, N93MTL3RRX, N93MTL3RX, N93MTW3LLX, N93MTW3LX, N93MTW3RRX, N93MTW3RX	Back Seat Lumbar Extreme Arm	1.70 2.50 1.10 1.20 1.60	2.00 4.50 2.00 1.80 1.80	2.80 6.30 2.30 2.00 2.80	4.30 7.50 3.00 3.00 3.00	33 50 22 24 31
N93MTL3LM, N93MTL3RM, N93MTW3LM, N93MTW3RM		6.90	11.00	15.00	17.30	138
N93MTL3LMX, N93MTL3RMX, N93MTW3LMX, N93MTW3RMX	Back Seat Lumbar Extreme Arm	1.70 2.50 1.10 1.20 2.30	2.00 4.50 2.00 1.80 2.50	2.80 6.30 2.30 2.00 4.00	4.30 7.50 3.00 3.00 4.30	33 50 22 24 45
N93MTL3M, N93MTW3M		4.70	8.50	11.00	13.00	93
N93MTL3MX, N93MTW3MX	Back Seat Lumbar Extreme	1.70 2.50 1.10 1.20	2.00 4.50 2.00 1.80	2.80 6.30 2.30 2.00	4.30 7.50 3.00 3.00	33 50 22 24
N93MTLC2, N93MTWC2	Complete	4.47	6.00	9.00	11.25	89.1

COM YARDAGE REQUIREMENTS

COM YARDAGE REQUIREMENTS (54" WIDTH – CUT UP THE ROLL)

MODEL	RAILROADED Contact customer service 800-634-9510 for ydg requirements	NON DIRECTIONAL OR SOLID	1"-4" REPEAT	5"-11" REPEAT	12"-18" REPEAT	COL SQUARE FEET
			4" VERTICAL X 4" HORIZONTAL	11" VERTICAL X 11" HORIZONTAL	18" VERTICAL X 18" HORIZONTAL	
N93MTLC2X, N93MTWC2X	Back	1.67	2.25	3.00	5.25	33.2
	Seat	1.97	2.50	4.50	5.50	39.3
	Lumbar	1.03	1.50	2.50	3.00	20.5
	Extreme	1.28	1.75	2.00	4.00	25.5
N93MTLC3, N93MTWC3	Complete	5.47	7.50	12.50	13.50	109
N93MTLC3X, N93MTWC3X	Back	2.08	2.50	3.50	5.50	41.5
	Seat	2.72	3.25	6.75	7.00	54.2
	Lumbar	1.50	2.00	3.00	3.50	29.9
	Extreme	1.28	2.00	2.50	4.00	25.5
N93MTLIN9, N93MTWIN9	Complete	3.72	5.25	7.00	8.50	74.2
N93MTLIN9X, N93MTWIN9X	Back	1.17	2.00	2.75	2.75	23.2
	Seat	1.78	2.50	3.75	5.00	35.4
	Lumbar	1.03	1.50	1.75	2.50	20.5
	Extreme	1.17	1.75	2.00	3.00	23.2
N93MTLSQ9D, N93MTWSQ9D	Complete	2.86	4.00	5.50	10.25	57
N93MTLSQ9DX, N93MTWSQ9DX	Back	1.17	1.50	2.00	3.25	23.2
	Seat	1.22	1.75	3.25	3.50	24.4
	Lumbar	0.78	1.00	2.00	2.50	15.5
	Extreme	1.28	1.50	1.75	3.25	25.5
N93MTLSQ9L, N93MTLSQ9R, N93MTWSQ9L, N93MTWSQ9R	Complete	2.69	4.00	5.25	10.25	53.7
N93MTLSQ9LX, N93MTLSQ9RX, N93MTWSQ9LX, N93MTWSQ9RX	Back	1.17	1.50	2.00	3.50	23.2
	Seat	1.17	1.50	3.00	4.00	23.2
	Lumbar	0.78	1.00	2.00	2.50	15.5
	Extreme	1.28	1.50	1.75	3.25	25.5
N93MTU2B, N93MTU2BB, N93MTU2BL, N93MTU2BR		7.20	10.80	14.10	15.50	143
N93MTU2BBX, N93MTU2BLX, N93MTU2BRX, N93MTU2BX	Back	1.20	1.30	2.50	2.50	24
	Seat	1.90	3.50	4.60	5.50	38
	Lumbar	0.90	1.50	2.00	2.00	17
	Extreme	1.20	2.50	2.90	3.30	24
	Arm	2.90	3.40	4.60	5.00	56
N93MTU2BM		8.80	12.20	17.00	18.00	174
N93MTU2BMX	Back	1.20	1.30	2.50	2.50	24
	Seat	1.90	3.50	4.60	5.50	38
	Lumbar	0.90	1.50	2.00	2.00	17
	Extreme	1.20	2.50	2.90	3.30	24
	Arm	4.40	4.80	6.00	7.00	87
N93MTU2L, N93MTU2LL, N93MTU2R, N93MTU2RR		6.00	9.20	12.30	13.50	118
N93MTU2LLX, N93MTU2LX, N93MTU2RRX, N93MTU2RX	Back	1.20	1.30	2.50	2.50	24
	Seat	1.90	3.50	4.60	5.50	38
	Lumbar	0.90	1.50	2.00	2.00	17
	Extreme	1.20	2.50	2.90	3.30	24
	Arm	1.60	1.80	2.80	3.00	31
N93MTU2LM, N93MTU2RM		6.70	9.90	13.50	14.80	132
N93MTU2LMX, N93MTU2RMX	Back	1.20	1.30	2.50	2.50	24
	Seat	1.90	3.50	4.60	5.50	38
	Lumbar	0.90	1.50	2.00	2.00	17
	Extreme	1.20	2.50	2.90	3.30	24
	Arm	2.30	2.50	4.00	4.30	45
N93MTU2M		4.40	7.40	9.50	10.50	87
N93MTU2MX	Back	1.20	1.30	2.50	2.50	24
	Seat	1.90	3.50	4.60	5.50	38
	Lumbar	0.90	1.50	2.00	2.00	17
	Extreme	1.20	2.50	2.90	3.30	24
N93MTU3B, N93MTU3BB, N93MTU3BL, N93MTU3BR		8.90	14.40	18.10	20.00	176

COM YARDAGE REQUIREMENTS

COM YARDAGE REQUIREMENTS (54" WIDTH – CUT UP THE ROLL)

MODEL	RAILROADED Contact customer service 800-634-9510 for ydg requirements	NON DIRECTIONAL OR SOLID	1"-4" REPEAT	5"-11" REPEAT	12"-18" REPEAT	COL SQUARE FEET
			4" VERTICAL X 4" HORIZONTAL	11" VERTICAL X 11" HORIZONTAL	18" VERTICAL X 18" HORIZONTAL	
N93MTU3BBX, N93MTU3BLX, N93MTU3BRX, N93MTU3BX	Back	1.70	2.00	2.80	4.30	33
	Seat	2.50	4.50	6.30	7.50	50
	Lumbar	1.10	2.00	2.30	3.00	22
	Extreme	2.30	3.80	1.30	4.80	43
	Arm	2.90	3.40	4.60	5.00	56
N93MTU3BM		10.40	15.80	19.50	22.00	207
N93MTU3BMX	Back	1.70	2.00	2.80	4.30	33
	Seat	2.50	4.50	6.30	7.50	50
	Lumbar	1.10	2.00	2.30	3.00	22
	Extreme	2.30	3.80	1.30	4.80	43
	Arm	4.40	4.80	6.00	7.00	87
N93MTU3L, N93MTU3LL, N93MTU3R, N93MTU3RR		7.60	12.80	16.30	18.00	151
N93MTU3LLX, N93MTU3LX, N93MTU3RRX, N93MTU3RX	Back	1.70	2.00	2.80	4.30	33
	Seat	2.50	4.50	6.30	7.50	50
	Lumbar	1.10	2.00	2.30	3.00	22
	Extreme	2.30	3.80	1.30	4.80	43
	Arm	1.60	1.80	2.80	3.00	31
N93MTU3LM, N93MTU3RM		8.30	13.50	17.50	19.30	165
N93MTU3LMX, N93MTU3RMX	Back	1.70	2.00	2.80	4.30	33
	Seat	2.50	4.50	6.30	7.50	50
	Lumbar	1.10	2.00	2.30	3.00	22
	Extreme	2.30	3.80	1.30	4.80	43
	Arm	2.30	2.50	4.00	4.30	45
N93MTU3M		6.00	11.00	13.50	15.00	120
N93MTU3MX	Back	1.70	2.00	2.80	4.30	33
	Seat	2.50	4.50	6.30	7.50	50
	Lumbar	1.10	2.00	2.30	3.00	22
	Extreme	2.30	3.80	1.30	4.80	43
N93MTUC2	Complete	6.00	8.00	12.75	14.50	119.5
N93MTUC2X	Back	1.67	2.25	3.00	5.25	33.2
	Seat	1.97	2.50	4.50	5.50	39.3
	Lumbar	1.03	1.50	2.25	2.75	20.5
	Extreme	4.25	4.75	5.00	6.00	84.7
N93MTUC3	Complete	7.69	10.00	17.25	17.25	153.3
N93MTUC3X	Back	2.08	2.50	3.50	5.50	41.5
	Seat	2.72	3.25	6.75	7.00	54.2
	Lumbar	1.50	2.00	3.00	3.50	29.9
	Extreme	4.25	6.00	6.50	7.75	84.7
N93MTUIN9	Complete	4.83	6.50	8.50	10.00	96.3
N93MTUIN9X	Back	1.17	2.00	2.75	2.75	23.2
	Seat	1.78	2.50	3.75	5.00	35.4
	Lumbar	1.03	1.50	1.75	2.50	20.5
	Extreme	2.17	2.50	2.75	3.25	43.2
N93MTUINR9	Complete	5.72	7.00	9.25	11.25	114
N93MTUINR9X	Back	1.28	2.00	2.75	3.00	25.5
	Seat	2.25	3.00	4.50	6.50	44.8
	Lumbar	1.28	1.75	2.00	2.50	25.5
	Extreme	2.25	2.50	2.75	3.50	44.8
N93MTUSQ9D	Complete	3.61	5.00	7.00	10.50	71.9
N93MTUSQ9DX	Back	1.17	1.50	2.00	3.25	23.2
	Seat	1.22	1.75	3.25	3.50	24.4
	Lumbar	0.78	1.00	2.00	2.50	15.5
	Extreme	2.17	2.50	2.75	3.25	43.2
N93MTUSQ9L, N93MTUSQ9R	Complete	3.61	4.50	7.00	10.50	71.9
N93MTUSQ9LX, N93MTUSQ9RX	Back	1.17	1.50	2.00	3.50	23.2
	Seat	1.17	1.50	3.00	4.00	23.2
	Lumbar	0.78	1.00	2.00	2.50	15.5
	Extreme	2.17	2.50	3.00	3.25	43.2