Collette

Product Specifications	82
Fabrics and Options	83
Contrasting Fabrics Specifications	84
Product Pages	85
COM Yardage Requirements	91

COLLETTE PRODUCT SPECIFICATIONS

FRAME CONSTRUCTION

- Interior frame is constructed of oriented strand board with tenon joints that are glued and screwed for maximum joint stability
- Frames and table platforms are wrapped in high grade polyurethane foam, custom shaped, fabricated, and slip-covered

SEAT CONSTRUCTION

- Seat cushions are attached to frame and feature an 8½" cushion constructed of an inner steel springcoil pack enveloped by high grade polyurethane foam

BACK CONSTRUCTION

- Back pillows are attached to back frame and feature a recycled polyester filled insert
- Back and seat cushions are attached but replaceable

ARM CONSTRUCTION

- Arms are wrapped in high grade polyurethane foam, custom shaped, fabricated and slip-covered
- Arms are connected to frame using 4 bolts per arm

UPHOLSTERY DETAILS

- Top stitch is a French seam and is offered in matching or contrasting thread colors, except on tables
- Comfort wrinkles on the seat and back cushions are an inherent part of the design
- Contrasting fabric available on all models, except tables

TABLE TOP

- Laminate surfaces are 1¾" thick HPL (high pressure laminate) and feature standard 3mm PVC edge
- Solid surfaces are 1¾" thick and feature a flat rim profile

LEGS

- Extruded aluminum square legs offered in Concrete, Cinder, Iron, Polished Aluminum, Platinum Metallic, and Satin Nickel Metallic
- Wood square legs offered in all Living by Kimball Hospitality seating finishes
- When specifying Brighton, Sonoma, and Natural finish, variation in color is acceptable due to the nature of wood characteristics
- U-Legs offered in Cinder, Polished, Platinum Metallic, and Satin Nickel Metallic

GLIDES

- Features 1" adjustable nylon leveling glides
- Soft/non-skid 1" adjustable glides are available for an additional upcharge

POWER AND USB GROMMET

- UL Listed
- 4-Trac® non-sequential daisy chain, hardwire, or plug solutions available
- Features 1 power outlet and 1 USB A+C combo ports
- Grommet available in black, silver, and white
- Up to 20 4-Trac grommets can be linked together
- Field installable when CUT-G35 is specified
- 4-Trac grommet must be used with 4-Trac power entry and electrical kits
- Tamper resistant and spill proof

POWER AND USB GROMMET - UNDERMOUNT

- UL Listed
- Features 1 power outlet and 2 USB (A) ports
- Only available in black
- Field installable, unit can be placed on the underside of any flat surface

TOSS PILLOWS

- Please refer to pages 651-656 under the Toss Accent Pillows section to review complementary pillow options that work well with the Collette series

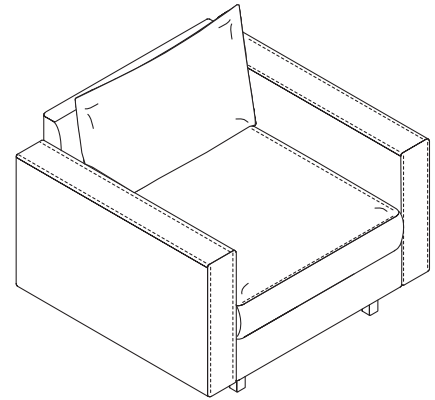

Dashed lines represent areas where matching or contrasting thread color is available

SURFACE MATERIALS

See the Kimball Hospitality Surface Materials Reference Guide at kimballhospitality.com for a complete overview of our materials program, including:

- Characteristics of wood
- Special wood finishes
- Customer-specified laminate (CSL)
- Customer-specified paint (CSP)
- Fabric application and colorways
- Customer's own material (COM) process overview
- Alliance program

ALLIANCE FABRIC PROGRAM

Kimball Hospitality has analyzed each model to most accurately reflect the COM/COL yardage requirements shown on page 91.

The yardage requirement for each model is based on 54" W fabric and cutting the fabric up the roll.

If repeat is larger than 18", contact Customer Service to confirm the correct amount of yardage required. When ordering 10 or more chairs in the same COM, yardage requirements may be reduced.

Contact Customer Service.

PRICE GRADES A-R

See Surface Materials at www.kimballhospitality.com for a wide variety of graded-in fabrics from Arc-Com, CF Stinson, Designtex, Maharam, Momentum, and Ultrafabrics.

FABRIC SAMPLES

If you need samples for presentation(s), contact our alliance partners directly at:

Arc-Com	800.223.5466	arc-com.com
Designtex	800.221.1540	designtex.com
CF Stinson	800.841.6279	cfstinson.com
Maharam	800.645.3943	maharam.com
Momentum	800.366.6839	memosamples.com
Ultrafabrics	877.309.6648	ultrafabricsllc.com

SQUARE LEG COLORS

METAL

S-423	Concrete
S-462	Cinder
S-463	Iron
S-497	Polished Aluminum
S-501	Platinum Metallic
S-503	Satin Nickel Metallic

WOOD

S-WAC	Autumn
S-WAD	Almond
S-WCL	Caramel
S-WCW	Cordovan
S-WDW	Judicial
S-WHN	Honey
S-WIM	Brighton
S-WMC	Amber
S-WMH	Mocha
S-WNM	Natural
S-WPB	Portobello
S-WPT	Portico
S-WSK	Skyline
S-WSM	Sonoma
S-WTF	Truffle
S-W405	Designer White
S-W462	Cinder
S-W792	Sable
S-W793	Acorn*

U-LEG COLORS

U-265	Polished
U-423	Concrete
U-462	Cinder
U-463	Iron
U-501	Platinum Metallic
U-503	Satin Nickel Metallic

GLIDES

STD	Standard
C66	Soft (add \$30 list)

THREAD COLORS

AA	Matching Thread
AB	White
AC	Beige
AD	Saddle
AG	Wine
AN	Black
AP	Buttercream
AQ	Tan
AR	Taupe
AS	Brown
AT	Rust
AU	Nickel
AV	Grey
AW	Cool Grey
AX	Scarlet
AY	Orange
AZ	Yellow
BA	Hunter
BB	Lime
BC	Turquoise
BD	Light Blue
BE	Royal
BF	Indigo
BG	Purple
BH	Pink

LAMINATE COLORS

WOODGRAIN LAMINATE

AC2	Autumn 2
AD	Almond
CL	Caramel
CW	Cordovan
DW	Judicial
HN2	Honey 2
IM	Brighton
MC	Amber
MH	Mocha
NM	Natural
PB	Portobello
PT	Portico
SK	Skyline
SM	Sonoma
TF	Truffle
792	Sable
793	Acorn*

SOLID LAMINATE

405	Designer White
419	Wallaby
425	Shadow
440	Cloud
461	Graphite
462	Cinder
478	Platinum Grey
488	Frosty White
491	Designer White Linear
492	Cinder Linear

*Acorn is the finish and laminate complement to Clear Walnut finish

POWER/USB GROMMET CUTOUT OPTIONS

If no grommet cutout is desired, specify an X (No Grommet)

\$25 list upcharge per cutout

CUT-G35L	Left
CUT-G35R	Right
CUT-G35LR	Left & Right
CUT-G35C	Center
CUT-G35LC	Left & Center
CUT-G35RC	Right & Center
CUT-G35A	Left, Right, & Center

Grommets sold separately; reference page 90 for model numbers and pricing.

SOLID SURFACE COLORS

7101	Bisque (Grade A)
7201	Glacier White (Grade A)
7202	Canyon (Grade B)
7203	Designer White (Grade B)
7204	Silt (Grade B)
7301	Concrete (Grade C)
7302	Deep Night Sky (Grade C)
7303	Deep Nocturne (Grade C)

GALLERY LAMINATE

Grade 1 – 5% upcharge	
G1001	Citadel
G1011	Pepperdust
Grade 2 – 6% upcharge	
G1002	Planked Raw Oak
G1003	Evening Notte
G1004	Kirsche
G1005	Midnight Run
G1006	Sepia Walnut
G1007	Serotina
G1008	Timeless
G1009	White Nebbia
G1012	Phantom Ecru

See page 20 for Gallery program details and upcharges

TO ORDER CONTRASTING FABRIC, SPECIFY

COLLETTE

1 Seat Lounge Square Leg page 85

2 Seat Lounge Square Leg page 85

3 Seat Lounge Square Leg page 86

90° Inside Corner Square Leg page 86

Ottoman Square Leg page 87

1 Seat Lounge U-Leg page 88

2 Seat Lounge U-Leg page 88

3 Seat Lounge U-Leg page 88

Ottoman U-Leg page 88

1. Model Number plus "X"
2. Back Fabric Grade Number/Cover Number
3. Seat Fabric Grade Number/Cover Number
4. Arm Fabric Grade Number/Cover Number (when applicable)
5. Upholstery Fabric Grade Number/Cover Number
6. Thread Color
7. Grommet
8. Leg Color
9. Glides

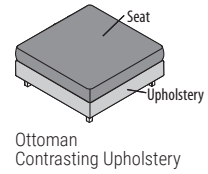
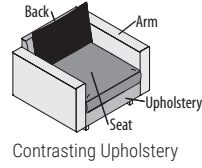

TO ORDER, SPECIFY:

1. Model Number
2. Fabric Grade / Cover Number
3. Thread Color
4. Grommet
5. Leg Color
6. Glides

- See page 83 for Collette options
- See pages 91-92 for COM fabric yardage

1 SEAT LOUNGE SQUARE LEG

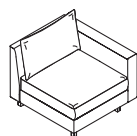

Left Arm, Square Leg

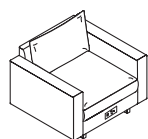

Arms, Square Leg, Grommet

MODEL NO.

ALLIANCE PROGRAM PRICE GRADES

			A	B	C	D	E	F	G	H	I
			J	K	L	M	N	O	P	Q	R
N84L1M	Armless, Square Leg	\$	2312	2465	2585	2716	2859	3013	3132	3286	3446
			3594	3839	4329	4631	4791	4956	5110	5270	5418
N84L1R	Right Arm, Square Leg		2559	2748	2895	3056	3231	3420	3567	3756	3952
			4134	4435	5037	5408	5604	5807	5996	6192	6374
N84L1L	Left Arm, Square Leg		2559	2748	2895	3056	3231	3420	3567	3756	3952
			4134	4435	5037	5408	5604	5807	5996	6192	6374
N84L1A	Arms, Square Leg		2808	3032	3206	3397	3604	3828	4003	4227	4459
			4675	5032	5746	6186	6418	6659	6883	7115	7331

DIMENSIONS

Armless Width	30	Seat Height	18½	Arm Width	5%	Armless Weight	66
Single Arm Width	35	Seat Depth	22	Arm Height	25¼	Single Arm Weight	84
Double Arm Width	40	Seat Width	30	Back Height	29	Double Arm Weight	104
Depth	35¼					Armless Cubic Ft.	32.0
Height	34½					Single Arm Cubic Ft.	32.0
						Arm Cubic Ft.	33.8

- Contrasting fabric option – specify X (i.e., N84L1MX); see page 84. For list pricing, use your electronic specification tool or contact customer service
- Grommet cutout option CUT-G35C is available

2 SEAT LOUNGE SQUARE LEG

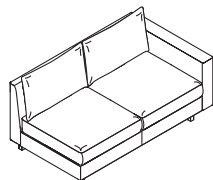

Left Arm, Square Leg

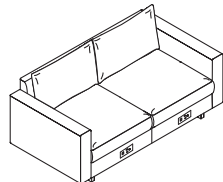

Arms, Square Leg, Grommets

			A	B	C	D	E	F	G	H	I
			J	K	L	M	N	O	P	Q	R
N84L2M	Armless, Square Leg	\$	3781	4069	4294	4540	4808	5097	5321	5610	5910
			6188	6648	7568	8135	8435	8745	9034	9334	9612
N84L2R	Right Arm, Square Leg		4028	4352	4604	4880	5180	5504	5756	6080	6416
			6728	7244	8276	8912	9248	9596	9920	10256	10568
N84L2L	Left Arm, Square Leg		4028	4352	4604	4880	5180	5504	5756	6080	6416
			6728	7244	8276	8912	9248	9596	9920	10256	10568
N84L2A	Arms, Square Leg		4276	4635	4914	5220	5552	5911	6191	6550	6922
			7268	7840	8984	9689	10061	10447	10806	11178	11524

DIMENSIONS

Armless Width	60	Seat Height	18½	Arm Width	5%	Armless Weight	137
Single Arm Width	65	Seat Depth	22	Arm Height	25¼	Single Arm Weight	155
Double Arm Width	70	Seat Width	60	Back Height	29	Double Arm Weight	165
Depth	35¼					Armless Cubic Ft.	56.6
Height	34½					Single Arm Cubic Ft.	56.6
						Arm Cubic Ft.	50.9

- Contrasting fabric option – specify X (i.e., N84L2MX); see page 84. For list pricing, use your electronic specification tool or contact customer service
- Grommet cutout options CUT-G35L, CUT-G35R, CUT-G35LR are available

COLLETTE

COLLETTE

TO ORDER, SPECIFY:

1. Model Number
2. Fabric Grade / Cover Number
3. Thread Color
4. Grommet
5. Leg Color
6. Glides

- See page 83 for Collette options
- See pages 91-92 for COM fabric yardage

3 SEAT LOUNGE SQUARE LEG

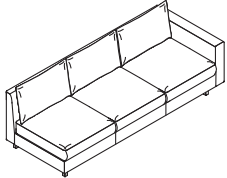

Left Arm, Square Leg

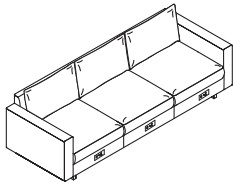

Arms, Square Leg, Grommets

MODEL NO.

ALLIANCE PROGRAM PRICE GRADES

			A	B	C	D	E	F	G	H	I
			J	K	L	M	N	O	P	Q	R
N84L3M	Armless, Square Leg	\$	5196	5619	5949	6310	6703	7127	7456	7880	8320
			8728	9403	10753	11585	12025	12480	12904	13344	13752
N84L3R	Right Arm, Square Leg		5443	5902	6259	6650	7075	7534	7891	8350	8826
			9268	9999	11461	12362	12838	13331	13790	14266	14708
N84L3L	Left Arm, Square Leg		5443	5902	6259	6650	7075	7534	7891	8350	8826
			9268	9999	11461	12362	12838	13331	13790	14266	14708
N84L3A	Arms, Square Leg		5691	6185	6569	6990	7447	7941	8326	8820	9332
			9808	10595	12169	13139	13651	14182	14676	15188	15664

DIMENSIONS

Armless Width	90	Seat Height	18½	Arm Width	5½	Armless Weight	188
Single Arm Width	95	Seat Depth	22	Arm Height	25¼	Single Arm Weight	206
Double Arm Width	100	Seat Width	90	Back Height	29	Double Arm Weight	225
Depth	35¼					Armless Cubic Ft.	68.5
Height	34½					Single Arm Cubic Ft.	68.5
						Arm Cubic Ft.	72.0

- Contrasting fabric option – specify X (i.e., N84L3MX); see page 84. For list pricing, use your electronic specification tool or contact customer service
- All grommet cutout options are available

90° INSIDE CORNER SQUARE LEG



Left, Grommet

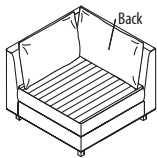

Right

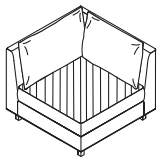

Diagonal

			A	B	C	D	E	F	G	H	I
			J	K	L	M	N	O	P	Q	R
N84IN9L	90° Inside Corner Left, Square Leg	\$	2740	2956	3124	3308	3508	3724	3892	4108	4332
			4540	4884	5572	5996	6220	6452	6668	6892	7100
N84IN9R	90° Inside Corner Right, Square Leg		2740	2956	3124	3308	3508	3724	3892	4108	4332
			4540	4884	5572	5996	6220	6452	6668	6892	7100
N84IN9D	90° Inside Corner Diagonal, Square Leg		2758	2985	3161	3354	3564	3791	3968	4194	4430
			4648	5009	5732	6177	6412	6656	6882	7118	7336

DIMENSIONS

Width	35¼	Seat Height	18½	Back Height	29	Weight	86
Depth	35¼	Seat Depth	22			Cubic Ft.	32.0
Height	34½	Seat Width	22				

- Contrasting fabric option – specify X (i.e., N84IN9LX); see page 84. For list pricing, use your electronic specification tool or contact customer service
- Grommet cutout options CUT-G35L and CUT-G35R are available

TO ORDER, SPECIFY:

1. Model Number
2. Laminate (when applicable)
3. Solid Surface Grade/Color (when applicable)
4. Fabric Grade / Cover Number
5. Thread Color (when applicable)
6. Leg Color
7. Grommet
8. Glides

- See page 83 for Collette options
- See pages 91-92 for COM fabric yardage

OTTOMAN SQUARE LEG

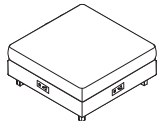

Square Leg, Grommets

MODEL NO.

ALLIANCE PROGRAM PRICE GRADES

			A	B	C	D	E	F	G	H	I
			J	K	L	M	N	O	P	Q	R
N84D1	Ottoman, 30", Square Leg	\$	1501	1590	1659	1735	1817	1906	1976	2065	2157
			2243	2385	2669	2844	2936	3032	3121	3213	3299
N84D2	Ottoman, 36", Square Leg		1845	1939	2013	2093	2181	2275	2349	2443	2541
			2632	2783	3084	3269	3367	3469	3563	3661	3752

30" DIMENSIONS

Width	30
Depth	30
Height	18½
Weight	52
Cubic Ft.	12.2

36" DIMENSIONS

Width	35¼
Depth	35¼
Height	18½
Weight	78
Cubic Ft.	17.3

- Contrasting fabric option – specify X (i.e., N84D1X); see page 84. For list pricing, use your electronic specification tool or contact customer service
- All grommet cutout options are available

END TABLE SQUARE LEG

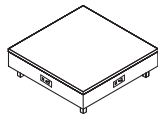

Square Leg, Grommets

			A	B	C	D	E	F	G	H	I
			J	K	L	M	N	O	P	Q	R
N84T36ENL	Laminate Top, Square Leg	\$	1114	1149	1176	1206	1238	1273	1301	1336	1372
			1406	1462	1574	1643	1679	1717	1752	1788	1822
N84T36ENS	Solid Surface Top, Grade A, Square Leg		2601	2636	2663	2693	2725	2760	2788	2823	2859
			2893	2949	3061	3130	3166	3204	3239	3275	3309

DIMENSIONS

Width	35¼
Depth	35¼
Height	11½

Weight	94
Weight - Solid Surface	125
Cubic Ft.	17.3

- Solid Surface Grades B and C list pricing – use your electronic specification tool or contact customer service
- All grommet cutout options are available

MAGAZINE TABLE SQUARE LEG

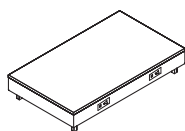

Square Leg, Grommets

			A	B	C	D	E	F	G	H	I
			J	K	L	M	N	O	P	Q	R
N84T60MGL	Laminate Top, Square Leg	\$	2033	2084	2124	2167	2215	2266	2306	2357	2411
			2460	2542	2705	2806	2859	2914	2965	3019	3068
N84T60MGS	Solid Surface Top, Grade A, Square Leg		4737	4788	4828	4871	4919	4970	5010	5061	5115
			5164	5246	5409	5510	5563	5618	5669	5723	5772

DIMENSIONS

Width	60
Depth	35¼
Height	11½

Weight	151
Weight - Solid Surface	202
Cubic Ft.	26.0

- Solid Surface Grades B and C list pricing – use your electronic specification tool or contact customer service
- Grommet cutout options CUT-G35L, CUT-G35R, CUT-G35LR are available

COLLETTE

COLLETTE

TO ORDER, SPECIFY:

1. Model Number
2. Fabric Grade / Cover Number
3. Thread Color
4. Grommet
5. Leg Color
6. Glides

- See page 83 for Collette options
- See pages 91-92 for COM fabric yardage

1 SEAT LOUNGE U-LEG

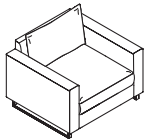

Arms, U-Leg

MODEL NO.

ALLIANCE PROGRAM PRICE GRADES

			A	B	C	D	E	F	G	H	I
			J	K	L	M	N	O	P	Q	R
N84L1UA	Arms, U-Leg	\$	3078	3302	3476	3667	3874	4098	4273	4497	4729
			4945	5302	6016	6456	6688	6929	7153	7385	7601

DIMENSIONS

Width	40	Seat Height	18½	Arm Width	5½	Weight	110
Depth	35¼	Seat Depth	22	Arm Height	25¼	Cubic Ft.	33.8
Height	34½	Seat Width	30	Back Height	29		

- Contrasting fabric option – specify X (i.e., N84L1UAX); see page 84. For list pricing, use your electronic specification tool or contact customer service
- Grommet cutout option CUT-G35C is available

2 SEAT LOUNGE U-LEG

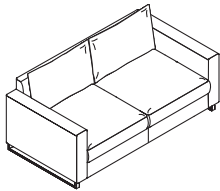

Arms, U-Leg

			A	B	C	D	E	F	G	H	I
			J	K	L	M	N	O	P	Q	R
N84L2UA	Arms, U-Leg	\$	4547	4906	5185	5491	5823	6182	6462	6821	7193
			7539	8111	9255	9960	10332	10718	11077	11449	11795

DIMENSIONS

Width	70	Seat Height	18½	Arm Width	5½	Weight	171
Depth	35¼	Seat Depth	22	Arm Height	25¼	Cubic Ft.	50.9
Height	34½	Seat Width	60	Back Height	29		

- Contrasting fabric option – specify X (i.e., N84L2UAX); see page 84. For list pricing, use your electronic specification tool or contact customer service
- Grommet cutout options CUT-G35L, CUT-G35R, CUT-G35LR are available

3 SEAT LOUNGE U-LEG

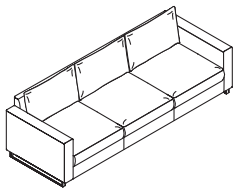

Arms, U-Leg

			A	B	C	D	E	F	G	H	I
			J	K	L	M	N	O	P	Q	R
N84L3UA	Arms, U-Leg	\$	5962	6456	6840	7261	7718	8212	8597	9091	9603
			10079	10866	12440	13410	13922	14453	14947	15459	15935

DIMENSIONS

Width	100	Seat Height	18½	Arm Width	5½	Weight	231
Depth	35¼	Seat Depth	22	Arm Height	25¼	Cubic Ft.	72.0
Height	34½	Seat Width	90	Back Height	29		

- Contrasting fabric option – specify X (i.e., N84L3UAX); see page 84. For list pricing, use your electronic specification tool or contact customer service
- All grommet cutout options are available

OTTOMAN U-LEG

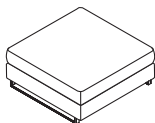

U-Leg

			A	B	C	D	E	F	G	H	I
			J	K	L	M	N	O	P	Q	R
N84D1U	Ottoman, 30", U-Leg	\$	1717	1806	1875	1951	2033	2122	2192	2281	2373
			2459	2601	2885	3060	3152	3248	3337	3429	3515
N84D2U	Ottoman, 36", U-Leg		2115	2209	2283	2363	2451	2545	2619	2713	2811
			2902	3053	3354	3539	3637	3739	3833	3931	4022

30" DIMENSIONS

Width	30
Depth	30
Height	18½
Weight	58
Cubic Ft.	12.2

36" DIMENSIONS

Width	35¼
Depth	35¼
Height	18½
Weight	84
Cubic Ft.	17.3

- Contrasting fabric option – specify X (i.e., N84D1UX); see page 84. For list pricing, use your electronic specification tool or contact customer service
- All grommet cutout options are available

TO ORDER, SPECIFY:

1. Model Number
2. Laminate (when applicable)
3. Solid Surface Grade/Color (when applicable)
4. Fabric Grade / Cover Number
5. Leg Color
6. Grommet
7. Glides

- See page 83 for Collette options
- See pages 91-92 for COM fabric yardage

**END TABLE
U-LEG**

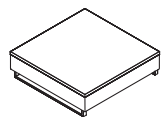

U-Leg

**MODEL
NO.**

ALLIANCE PROGRAM PRICE GRADES

			A	B	C	D	E	F	G	H	I
			J	K	L	M	N	O	P	Q	R
N84T36ENUL	Laminate Top, U-Leg	\$	1330	1365	1392	1422	1454	1489	1517	1552	1588
			1622	1678	1790	1859	1895	1933	1968	2004	2038
N84T36ENUS	Solid Surface Top, Grade A, U-Leg		2871	2906	2933	2963	2995	3030	3058	3093	3129
			3163	3219	3331	3400	3436	3474	3509	3545	3579

DIMENSIONS

Width	35¼	Weight	94
Depth	35¼	Weight - Solid Surface	125
Height	11½	Cubic Ft.	17.3

- Solid Surface Grades B and C list pricing – use your electronic specification tool or contact customer service
- All grommet cutout options are available

**MAGAZINE TABLE
U-LEG**

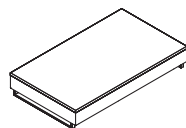

U-Leg

			A	B	C	D	E	F	G	H	I
			J	K	L	M	N	O	P	Q	R
N84T60MGUL	Laminate Top, U-Leg	\$	2303	2354	2394	2437	2485	2536	2576	2627	2681
			2730	2812	2975	3076	3129	3184	3235	3289	3338
N84T60MGUS	Solid Surface Top, Grade A, U-Leg		5007	5058	5098	5141	5189	5240	5280	5331	5385
			5434	5516	5679	5780	5833	5888	5939	5993	6042

DIMENSIONS

Width	60	Weight	151
Depth	35¼	Weight - Solid Surface	202
Height	11½	Cubic Ft.	26.0

- Solid Surface Grades B and C list pricing – use your electronic specification tool or contact customer service
- Grommet cutout options CUT-G35L, CUT-G35R, CUT-G35LR are available

COLLETTE

TO ORDER, SPECIFY:

• See page 83 for Collette options

1. Model Number

POWER/USB GROMMET - PLUGGED

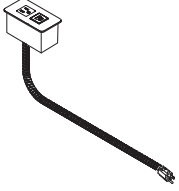

MODEL NO.		LIST PRICE	CARTONED WEIGHT	CUBIC FEET
NACG35AELPGB	Black	\$ 444	1.5 lbs.	0.3
NACG35AELPGS	Silver	444	1.5 lbs.	0.3
NACG35AELPGW	White	444	1.5 lbs.	0.3

- Features 1 power outlet and 1 USB (A+C) combo ports
- Includes black 72" long 3-prong power cord
- Power outlet provides 15 amps

BRACKET

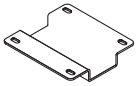

Ganging Bracket Kit

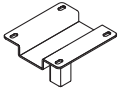

Leg Ganging Bracket Kit

N84GK	Ganging Bracket Kit (2 Brackets)	\$ 92	2.5 lbs.	0.2
N84GKL	Leg Ganging Bracket Kit (2 Brackets With Legs)	157	3.0 lbs.	0.2

- Ganging bracket kit includes required brackets to join 2 units together
- Leg ganging bracket kit allows the removal of front and back legs when ganging 2 units
- Both bracket models provide wire management

COM YARDAGE REQUIREMENTS

COM YARDAGE REQUIREMENTS (54" WIDTH – CUT UP THE ROLL)

MODEL	RAILROADED Contact customer service 800-634-9510 for ydg requirements	NON DIRECTIONAL OR SOLID	1"-4" REPEAT	5"-11" REPEAT	12"-18" REPEAT	COL SQUARE FEET
			4" VERTICAL X 4" HORIZONTAL	11" VERTICAL X 11" HORIZONTAL	18" VERTICAL X 18" HORIZONTAL	
N84L1A		8.30	8.90	12.20	14.70	165
N84L1AX	Upholstery	2.40	2.90	4.20	4.70	47
	Seat	2.10	2.70	4.60	5.70	41
	Back	1.30	1.60	2.20	3.30	26
	Arm	2.60	3.20	3.90	7.50	52
N84L1UA		8.30	8.90	12.20	14.70	165
N84L1UAX	Upholstery	2.40	2.90	4.20	4.70	47
	Seat	2.10	2.70	4.60	5.70	41
	Back	1.30	1.60	2.20	3.30	26
	Arm	2.60	3.20	3.90	7.50	52
N84L1L		7.00	7.80	10.80	13.20	139
N84L1LX	Upholstery	2.40	2.90	4.20	4.70	47
	Seat	2.10	2.90	4.20	4.70	47
	Back	1.30	1.60	2.20	3.30	26
	Arm	1.30	1.70	2.50	4.50	27
N84L1R		7.00	7.50	10.80	13.20	138
N84L1RX	Upholstery	2.40	2.90	4.20	4.70	47
	Seat	2.10	2.70	2.70	5.70	41
	Back	1.30	1.60	2.20	3.30	26
	Arm	1.30	1.70	2.50	4.50	27
N84L1M		5.70	6.60	9.40	10.70	39
N84L1MX	Upholstery	2.40	2.90	4.20	4.70	47
	Seat	2.10	2.70	4.60	5.70	41
	Back	1.30	1.60	2.20	3.30	26
N84L2A		13.30	14.70	19.70	23.20	266
N84L2AX	Upholstery	4.20	4.80	6.70	7.00	82
	Seat	4.20	5.00	8.70	10.70	83
	Back	2.60	2.80	3.40	3.50	51
	Arm	2.60	3.20	3.90	7.50	52
N84L2UA		13.30	14.70	19.70	23.20	266
N84L2UAX	Upholstery	4.20	4.80	6.70	7.00	82
	Seat	4.20	5.00	8.70	10.70	83
	Back	2.60	2.80	3.40	3.50	51
	Arm	2.60	3.20	3.90	7.50	52
N84L2L		12.00	13.40	18.40	21.20	241
N84L2LX	Upholstery	4.20	4.80	6.70	7.00	82
	Seat	4.20	5.00	8.70	10.70	83
	Back	2.60	2.80	3.40	3.50	51
	Arm	1.30	1.70	2.50	4.50	27
N84L2R		12.00	13.40	18.40	21.20	241
N84L2RX	Upholstery	4.20	4.80	6.70	7.00	82
	Seat	4.20	5.00	8.70	10.70	83
	Back	2.60	2.80	3.40	3.40	51
	Arm	1.30	1.70	2.50	4.50	27
N84L2M		10.70	12.00	16.10	18.70	214
N84L2MX	Upholstery	4.20	4.80	6.70	7.00	82
	Seat	4.20	5.00	8.80	10.70	83
	Back	2.60	2.80	3.40	3.40	51
N84L3A		18.30	20.10	27.30	31.20	364
N84L3AX	Upholstery	5.90	9.00	12.20	12.50	120
	Seat	6.30	7.00	12.90	15.70	124
	Back	3.90	4.20	4.80	5.00	73
	Arm	2.60	3.20	3.90	7.50	52
N84L3UA		18.30	20.10	27.30	31.20	364
N84L3UAX	Upholstery	5.90	9.00	12.20	12.50	120
	Seat	6.30	7.00	12.90	15.70	124
	Back	3.90	4.20	4.80	5.00	73
	Arm	2.60	3.20	3.90	7.50	52
N84L3L		17.00	18.90	25.90	29.10	338

COM YARDAGE REQUIREMENTS

COM YARDAGE REQUIREMENTS (54" WIDTH – CUT UP THE ROLL)

MODEL	RAILROADED Contact customer service 800-634-9510 for ydg requirements	NON DIRECTIONAL OR SOLID	1"-4" REPEAT	5"-11" REPEAT	12"-18" REPEAT	COL SQUARE FEET
			4" VERTICAL X 4" HORIZONTAL	11" VERTICAL X 11" HORIZONTAL	18" VERTICAL X 18" HORIZONTAL	
N84L3LX	Upholstery	5.90	9.30	12.20	12.70	120
	Seat	6.30	9.00	12.20	12.50	128
	Back	3.90	4.20	4.80	5.00	73
	Arm	1.30	1.70	2.50	4.50	27
N84L3R		17.00	18.90	25.90	29.10	338
N84L3RX	Upholstery	5.90	9.30	12.20	12.70	120
	Seat	6.30	9.00	12.20	12.50	128
	Back	3.90	4.20	4.80	5.00	73
	Arm	1.30	1.70	2.50	4.50	27
N84L3M		15.70	17.70	24.50	26.70	313
N84L3MX	Upholstery	5.90	9.30	12.20	12.70	120
	Seat	6.30	9.30	12.20	12.70	128
	Back	3.90	4.20	4.80	5.00	73
N84IN9L		8.00	8.70	11.50	11.70	160
N84IN9LX	Upholstery	3.70	4.00	5.60	5.90	80
	Seat	2.10	9.00	12.20	12.50	44
	Back	2.50	2.90	3.40	3.70	50
N84IN9R		8.00	8.70	11.50	11.70	160
N84IN9RX	Upholstery	3.70	4.00	5.60	5.90	80
	Seat	2.10	9.00	12.20	12.50	44
	Back	2.50	2.90	3.40	3.70	50
N84IN9D		8.40	9.60	12.90	15.20	173
N84IN9DX	Upholstery	3.70	4.70	6.70	7.00	83
	Seat	2.50	2.80	4.60	6.70	48
	Back	2.50	2.90	3.40	3.90	50
N84D1		3.30	3.80	7.00	9.10	67
N84D1X	Upholstery	1.20	1.80	3.20	4.70	26
	Seat	2.10	2.50	4.30	5.20	42
N84D1U		3.30	3.80	7.00	9.10	67
N84D1UX	Upholstery	1.20	1.80	3.20	4.70	26
	Seat	2.10	2.50	4.30	5.20	42
N84D2		3.50	4.00	7.00	10.10	70
N84D2X	Upholstery	1.20	1.80	3.20	4.70	26
	Seat	2.30	2.60	4.30	6.20	45
N84D2U		3.50	4.00	7.00	10.10	70
N84D2UX	Upholstery	1.20	1.80	3.20	4.70	26
	Seat	2.30	2.60	4.30	6.20	45
N84T36ENL		1.30	2.30	4.60	6.70	37
N84T36ENUL		1.30	2.30	4.60	6.70	37
N84T36ENS		1.30	2.30	4.60	6.70	37
N84T36ENUS		1.30	2.30	4.60	6.70	37
N84T60MGL		1.90	2.00	3.10	4.70	26
N84T60MGUL		1.90	2.00	3.10	4.70	26
N84T60MGS		1.90	2.00	3.40	4.70	26
N84T60MGUS		1.90	2.00	3.40	4.70	26