Pairings Health

Product Specifications	484
Fabrics and Options	485
Contrasting Fabrics Specifications	488
Product Pages	490
COM Yardage Requirements	512

PAIRINGS HEALTH PRODUCT SPECIFICATIONS

FRAME CONSTRUCTION

- Frame is constructed of plywood, using a lap-joint construction method
- Frames are glued and screwed

SEAT CONSTRUCTION

- Seats feature a high tension, strip webbing suspension that is stapled to the frame
- Seat upholstery features a wrap-around upholstery method and is stapled into place
- Clean out design allows for easy clean up of debris or liquids
- Clean out space does not detract from the aesthetic or function of the lounge

CUSHIONS

- Cushions are made of high grade, high resiliency, CFC-free, laminated polyurethane foam
- Seat cushions are 2¾" thick
- Back cushions are 2" thick and upholstered using the slipcover method and finished with French seams:
 - Double stitch seams in center (27" wide segments)
 - Single French seams at sides of lounge to create double stitch appearance when joined with other lounge units

CONTRASTING FABRIC

- Contrasting fabric may be specified for back, seat, and arms.
- While seat and back upholstery will align on a unit, there is no guarantee that individual models will align when attached to each other
- Fabrics reflect light differently when viewed at various angles, creating a natural phenomenon called "flip." Flip is visible on all fabrics and is not considered a defect; it is more easily recognized on fabrics with a nap or shimmer

ARMS

- Arm tops and outside panels feature ¾"-thick, high grade polyurethane foam
- Arms feature a sewn slipcover with French seams that is stapled into place

TABLETS

- Available as an option in 3D laminate, HPL with a phenolic core, or wood. They swivel 360 degrees

HANDING DESIGNATION (LEFT OR RIGHT OF UNIT)

- Determined from the user's perspective when seated

TECH ARM

- Models with tech arm feature an HPL with phenolic core tablet on an articulating arm

POWER/USB

- Power/USB modules are available on left, right, or left and right kickrail as well as left, right, or left and right front of arm on 8" and tech arms. See page 487

LEGS

- Legs are 9¼" high and available in two shapes:
 - Metal spider leg
 - Round wood leg (upcharge applies)
- Non-skid, adjustable glides are 2" in diameter

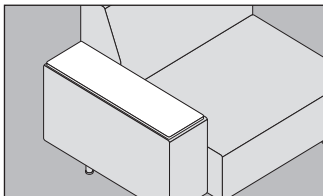
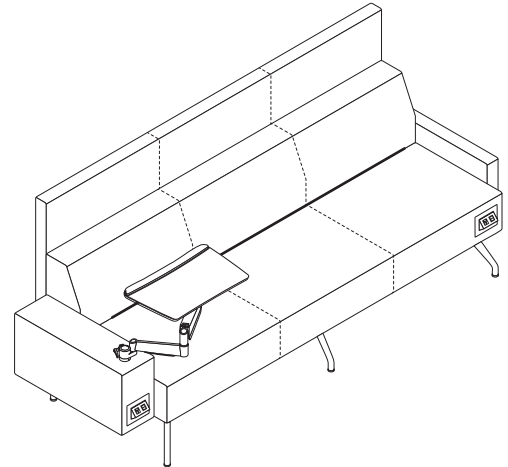

Arm caps

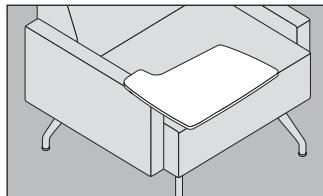

Tablet arms

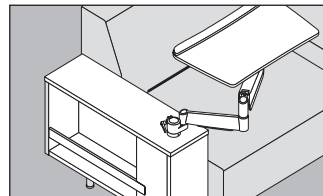

Storage tech arm

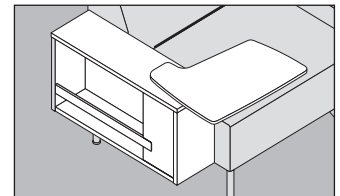

Storage tablet arm

FABRIC APPLICATION DIAGRAMS

90° CORNERS:

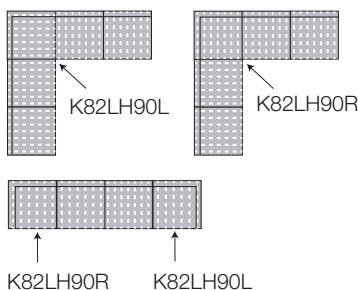

CORNER BENCHES:

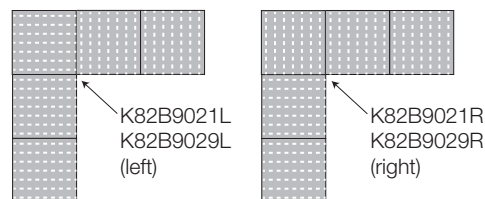

SURFACE MATERIALS

See the Kimball Hospitality Surface Materials Reference Guide at kimballhospitality.com for a complete overview of our materials program, including:

- Characteristics of wood
- Special wood finishes
- Customer specified laminate (CSL)
- Customer specified paint (CSP)
- Fabric application and colorways
- Customer's own material (COM) process overview
- Alliance program

ALLIANCE FABRIC PROGRAM

Kimball Hospitality has analyzed each model to most accurately reflect the COM/COL yardage requirements shown on page 512.

The yardage requirement for each model is based on 54" wide fabric and cutting the fabric up the roll.

If repeat is larger than 18", contact Customer Service to confirm the correct amount of yardage required. When ordering 10 or more chairs in the same COM, yardage requirements may be reduced.

Contact Customer Service.

PRICE GRADES A-R

See Surface Materials at www.kimballhospitality.com for a wide variety of graded-in fabrics from Arc-Com, Carnegie, CF Stinson, Designtex, Maharam, Mayer, Momentum, and Ultrafabrics.

FABRIC SAMPLES

If you need samples for presentation(s), contact our alliance partners directly at:

Arc-Com	800.223.5466	arc-com.com
Carnegie	800.727.6770	carnegiefabrics.com
CF Stinson	800.841.6279	cfstinson.com
Designtex	800.221.1540	designtex.com
Maharam	800.645.3943	maharam.com
Mayer	800.428.4415	mayerfabrics.com
Momentum	800.366.6839	memosamples.com
Ultrafabrics	877.309.6648	ultrafabricsllc.com

ARM CAPS

3D LAMINATE

WOODGRAIN

CO	Canyon
DF	Driftwood
MH	Mocha
YO	Monterey
NW	Tuscan

SOLID COLOR

462	Cinder
440	Cloud
405	Designer White
450	Fog

SOLID SURFACE

STANDARD

7101	Bisque
405	Designer White

PREMIUM*

467	Carbon Concrete
468	Neutral Concrete
464	Peace Grey
469	Weathered Concrete

*Upcharge applies

WOOD

BZ	Brazilwood	MH	Mocha
CO	Canyon	YO	Monterey
CI	Chai	PC	Porcini
CC	Cordoba	PB	Portobello
DF	Driftwood	792	Sable
KN	Kona	NW	Tuscan
MW	Midtown	WL	Willow

IMPORTANT: Hardwood finishes on seating are complementary to veneer finishes on casegoods and tables, but may not be a direct match due to the difference in substrates.

Contact Customer Service for more information

TABLET TOPS

3D LAMINATE

WOODGRAIN

MC	Amber Cherry
MH	Mocha Cherry
CO	Canyon Straight Grain
DF	Driftwood Straight Grain
YO	Monterey Straight Grain
NW	Tuscan Straight Grain

SOLID

462	Cinder
440	Cloud
405	Designer White
450	Fog

TABLET / TECH ARM TABLET

HIGH PRESSURE LAMINATE (HPL)

WOODGRAIN

BZ	Brazilwood
CO	Canyon
CI	Chai
DF	Driftwood
KN	Kona
YO	Monterey
PC	Porcini
PB	Portobello
792	Sable
NW	Tuscan
WL	Willow

SOLID COLOR

462	Cinder
440	Cloud
457	Dapple
405	Designer White

LEGS

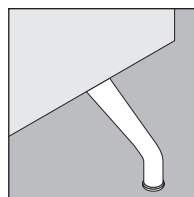

SPIDER LEG

No designator
(No upcharge)

FINISHES

494	Brushed Aluminum
497	Polished Aluminum

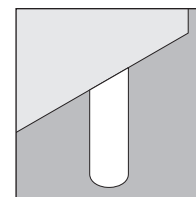

ROUND LEG

Designator = **R**
(+\$125 per model)

WOOD

BZ	Brazilwood	MH	Mocha
CO	Canyon	YO	Monterey
CI	Chai	PC	Porcini
CC	Cordoba	PB	Portobello
DF	Driftwood	792	Sable
KN	Kona	NW	Tuscan
MW	Midtown	WL	Willow

For round leg option, specify the leg designator and finish designator together in one step.

Examples:

RMC = Round wood leg in Amber
RUW = Round wood leg in Urban

PAIRINGS HEALTH

ARM CAPS

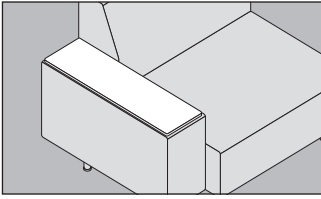

Arm cap substitution, when desired, must be made for each arm, and *must be the same* on both arms for models with arms on both sides (regardless if it is 2", 8", 8" tech arm, or a combination)

For example:

K82LH32L**AU**2**RAU**PFB would become K82LH32L**AW**2**RAW**PFB to add wood arm caps on both arms

IMPORTANT: Upcharges listed are per arm.

Handing designation (left or right of unit) is determined from the user's perspective when seated

TABLE ARMS

Tablet arm substitution is available on select models. See individual pricing page for availability by model

Tablet arms are available on both arms of two and three seat models with 8" arms only; tablet materials must match

Tablet arm/arm cap combinations are only available in the combinations at below and at right

Tablet arms are mounted to upholstered arms

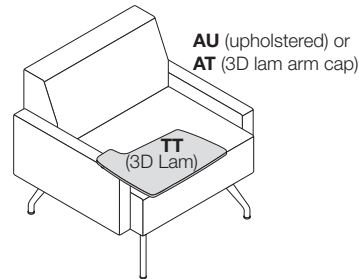
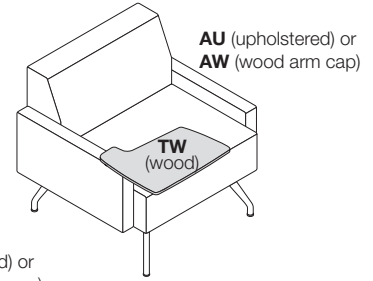
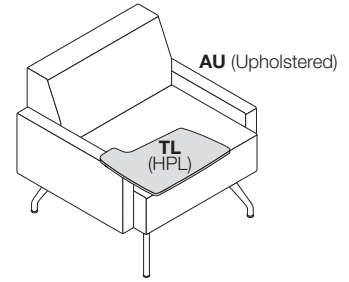

HOW TO SPECIFY

DESCRIPTION	HOW TO SPECIFY	ON 2" ARM (PER ARM)	ON 8" ARM (PER ARM)	ON 8" TECH ARM (PER ARM)
ARM CAPS				
3D laminate arm cap	Substitute AT for AU in model	+\$55	+\$68	+\$68
Wood arm cap	Substitute AW for AU in model	+\$86	+\$104	+\$104
Solid surface arm cap	Substitute AS for AU in model	+\$112	+\$140	+\$140
TABLET ARMS				
3D laminate tablet	Substitute TT for AU in model	+\$124	+\$153	—
HPL tablet with phenolic core	Substitute TL for AU in model	+\$347	+\$432	—
Wood tablet	Substitute TW for AU in model	+\$362	+\$445	—

FACTORY-INSTALLED POWER/USB OPTIONS FOR LOUNGE SEATING

KICKRAIL POWER/USB:

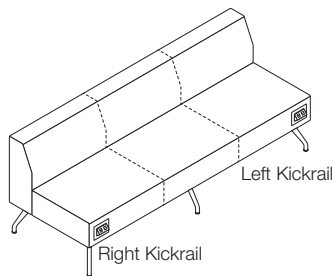
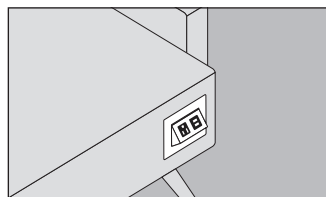

ARM POWER/USB:

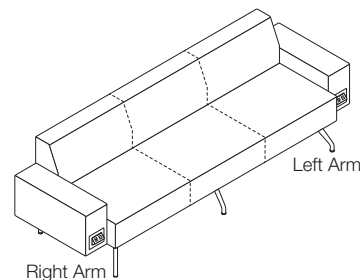
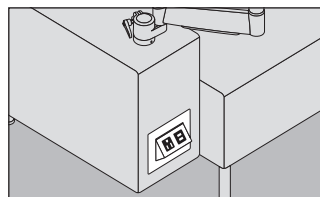

HOW TO SPECIFY

1. Insert the power module designator in applicable step in the model number sequence

LOCATION	OPTION DESIGNATORS	OPTION DESIGNATORS	UPCHARGE
	KICK RAIL POWER/USB	8" OR TECH ARM POWER/USB	
Left front (as seated)	G55KRPL	G55APL	+\$490
	G56KRPL	G56APL	+\$524
Right front (as seated)	G55KRPR	G55APR	+\$490
	G56KRPR	G56APR	+\$524
Left and right front (as seated)	G55KRPLR	G55APLR	+\$980
	G56KRPLR	G56APLR	+\$1048

IMPORTANT: Specify based on connector type, cord length and circuit configuration:

- G55** 6' cord with three-prong plug
- G56** 10' cord with three-prong plug

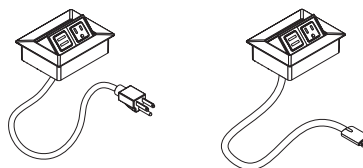

Power/USB modules feature a single-sided, pneumatic pop-out. Actual cut-out size is for 4" x 5". Modules are painted in platinum metallic

Handing designation (left or right of unit) is determined from the user's perspective when seated

TO ORDER CONTRASTING FABRIC, SPECIFY

PAIRINGS HEALTH

Armless Lounge page 490

Corner & Crescent page 508

1. Model Number plus "X"
2. Back Fabric Grade
3. Back Fabric Number
4. Seat Fabric Grade
5. Seat Fabric Number
6. Kickrail Power/USB Option
7. Leg Option



Contrasting Fabric may be specified on seat and back

One Seat Lounge, 2" Arms page 491

Two Seat Lounge 2" Arms page 501

Three Seat Lounge 2" Arms page 505

1. Model Number plus "X"
2. Back Fabric Grade
3. Back Fabric Number
4. Seat Fabric Grade
5. Seat Fabric Number
6. Arm Fabric Grade
7. Arm Fabric Number
8. Arm Cap or Tablet Arm Finish Price Group (if applicable)
9. Arm Cap or Tablet Arm Finish Designator (if applicable)
10. Kickrail Power/USB Option
11. Leg Option



Contrasting Fabric may be specified on seat, back, and arm

One Seat Lounge 8" Arms page 492

Two Seat Lounge 8" Arms page 502

1. Model Number plus "X"
2. Back Fabric Grade
3. Back Fabric Number
4. Seat Fabric Grade
5. Seat Fabric Number
6. Arm Fabric Grade
7. Arm Fabric Number
8. Arm Cap or Tablet Arm Finish Price Group (if applicable)
9. Arm Cap or Tablet Arm Finish Designator (if applicable)
10. Kickrail Power/USB Option
11. Arm Power/USB Option
12. Leg Option



Contrasting Fabric may be specified on seat, back, and arm

One Seat Lounge Tech Arm Left page 493

One Seat Lounge Tech Arm Right page 494

Two Seat Lounge Tech Arm Left or Both Sides page 503

Two Seat Lounge Tech Arm Right page 504

Three Seat Lounge Tech Arm Left or Both Sides page 506

Three Seat Lounge Tech Arm Right page 507

1. Model Number plus "X"
2. Back Fabric Grade
3. Back Fabric Number
4. Seat Fabric Grade
5. Seat Fabric Number
6. Arm Fabric Grade
7. Arm Fabric Number
8. Arm Cap Finish Price Group (if applicable)
9. Arm Cap Finish Designator (if applicable)
10. Tech Tablet Laminate Price Group
11. Tech Tablet Laminate Designator
12. Kickrail Power/USB Option
13. Arm Power/USB Option
14. Leg Option



Contrasting Fabric may be specified on seat, back, and arm

One Seat Lounge TFL Storage Tech Arm Left page 495
One Seat Lounge TFL Storage Tech Arm Right page 496

1. Model Number plus "X"
2. Back Fabric Grade
3. Back Fabric Number
4. Seat Fabric Grade
5. Seat Fabric Number
6. Arm Fabric Grade (2" or 8" arm only)
7. Arm Fabric Number (2" or 8" arm only)
8. Tech Tablet HPL Price Group
9. Tech Tablet HPL Designator
10. Storage TFL Designator
11. Kickrail Power/USB Option
12. Arm Power/USB Option
13. Leg Option



Contrasting Fabric may be specified on seat, back, and arms

One Seat Lounge Wood Storage Tech Arm Left page 497
One Seat Lounge Wood Storage Tech Arm Right page 498

1. Model Number plus "X"
2. Back Fabric Grade
3. Back Fabric Number
4. Seat Fabric Grade
5. Seat Fabric Number
6. Arm Fabric Grade (2" or 8" arm only)
7. Arm Fabric Number (2" or 8" arm only)
8. Tech Tablet HPL Price Group
9. Tech Tablet HPL Designator
10. Storage Wood Price Group
11. Storage Wood Finish Designator
12. Kickrail Power/USB Option
13. Arm Power/USB Option
14. Leg Option



Contrasting Fabric may be specified on seat, back, and arm

One Seat Lounge TFL Storage Tablet Arm Left or Right page 499

1. Model Number plus "X"
2. Back Fabric Grade
3. Back Fabric Number
4. Seat Fabric Grade
5. Seat Fabric Number
6. Tablet HPL or Wood Price Group
7. Tablet Finish Designator
8. Storage TFL Designator
9. Kickrail Power/USB Option
10. Arm Power/USB Option
11. Leg Option



Contrasting Fabric may be specified on seat, back, and arm

One Seat Lounge Wood Storage Tablet Arm Left or Right page 500

1. Model Number plus "X"
2. Back Fabric Grade
3. Back Fabric Number
4. Seat Fabric Grade
5. Seat Fabric Number
6. Tablet HPL Price Group (HPL only)
7. Tablet Finish Designator (3D laminate and HPL only)
8. Storage Wood Price Group
9. Storage Wood Designator
10. Kickrail Power/USB Option
11. Arm Power/USB Option
12. Leg Option



Contrasting Fabric may be specified on seat, back, and arm

PAIRINGS HEALTH

TO ORDER, SPECIFY

1. Model Number
2. Back Fabric Grade
3. Back Fabric Number
4. Seat Fabric Grade
5. Seat Fabric Number
6. Kickrail Power/USB Option
7. Leg Option

• See pages 485-487 for Pairings Health options
See pages 512-531 for COM fabric yardage

ARMLESS LOUNGE



One Seat

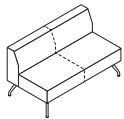

Two Seat

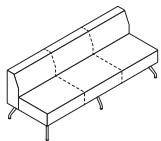

Three Seat

MODEL NO.

ALLIANCE PROGRAM PRICE GRADES

			A	B	C	D	E	F	G	H	I
			J	K	L	M	N	O	P	Q	R
K82LH1	One Seat	\$	2381	2499	2591	2684	2784	2902	2969	3098	3205
			3316	3494	3849	4074	4123	4167	4222	4275	4523
K82LH2	Two Seat		3312	3500	3647	3795	3955	4144	4250	4456	4627
			4804	5088	5653	6013	6091	6161	6249	6332	6728
K82LH3	Three Seat		4625	4904	5122	5339	5574	5852	6009	6313	6566
			6827	7244	8080	8610	8723	8828	8958	9080	9663

DIMENSIONS - ONE SEAT

Width	27	Seat Height	18	Weight	38.50
Depth	29	Seat Depth	21	Cubic Ft.	13.50
Height	30	Seat Width	27		

DIMENSIONS - TWO SEAT

Width	54	Seat Height	18	Weight	60.20
Depth	29	Seat Depth	21	Cubic Ft.	36.50
Height	30	Seat Width	54		

DIMENSIONS - THREE SEAT

Width	81	Seat Height	18	Weight	85.70
Depth	29	Seat Depth	21	Cubic Ft.	54.20
Height	30	Seat Width	81		

- Contrasting fabric option – specify X (i.e., K82LH1X); see page 488. For list pricing, use your electronic specification tool or contact customer service
- Kickrail power/USB
- Leg options

TO ORDER, SPECIFY

1. Model Number
2. Back Fabric Grade
3. Back Fabric Number
4. Seat Fabric Grade
5. Seat Fabric Number
6. Arm Fabric Grade
7. Arm Fabric Number
8. Arm Cap or Tablet Arm Finish Price Group (if applicable)
9. Arm Cap or Tablet Arm Finish Designator (if applicable)
10. Kickrail Power/USB Option
11. Leg Option

• See pages 485-487 for Pairings Health options
See pages 512-531 for COM fabric yardage

**ONE SEAT LOUNGE
2" ARMS**



Left Arm



Right Arm



Left and Right Arms

**MODEL
NO.**

ALLIANCE PROGRAM PRICE GRADES

		A	B	C	D	E	F	G	H	I
		J	K	L	M	N	O	P	Q	R
K82LH12LAU	2" Arm Left	\$ 2846	2996	3113	3231	3358	3508	3593	3757	3893
		4034	4260	4711	4997	5059	5115	5185	5252	5567
K82LH12RAU	2" Arm Right	2846	2996	3113	3231	3358	3508	3593	3757	3893
		4034	4260	4711	4997	5059	5115	5185	5252	5567
K82LH12LAU2RAU	2" Arms Left and Right	3300	3479	3619	3759	3911	4089	4191	4386	4548
		4716	4985	5523	5864	5937	6004	6088	6167	6543

DIMENSIONS

Width - L or R	29	Seat Height	18	Arm Height	22	Weight - L or R	38.50
Width - L and R	31	Seat Depth	21	Arm Depth	26	Weight - L and R	49.70
Depth	29	Seat Width	27	Arm Width	2	Cubic Ft. - L or R	13.50
Height	30					Cubic Ft. - L and R	14.70

- Contrasting fabric option – specify X (i.e., K82LH12LAUX); see page 488. For list pricing, use your electronic specification tool or contact customer service
- Arm options
- Kickrail power/USB
- Leg options

PAIRINGS HEALTH

TO ORDER, SPECIFY

1. Model Number
2. Back Fabric Grade
3. Back Fabric Number
4. Seat Fabric Grade
5. Seat Fabric Number
6. Arm Fabric Grade
7. Arm Fabric Number
8. Arm Cap or Tablet Arm Finish Price Group (if applicable)
9. Arm Cap or Tablet Arm Finish Designator (if applicable)
10. Kickrail Power/USB Option
11. Arm Power/USB Option
12. Leg Option

• See pages 485-487 for Pairings Health options
See pages 512-531 for COM fabric yardage

ONE SEAT LOUNGE 8" ARMS



Left Arm



Right Arm



Left and Right Arms

MODEL NO.

ALLIANCE PROGRAM PRICE GRADES

			A	B	C	D	E	F	G	H	I
			J	K	L	M	N	O	P	Q	R
K82LH18LAU	8" Arm Left	\$	2939	3089	3206	3324	3451	3601	3686	3850	3986
			4127	4353	4804	5090	5152	5208	5278	5345	5660
K82LH18RAU	8" Arm Right		2939	3089	3206	3324	3451	3601	3686	3850	3986
			4127	4353	4804	5090	5152	5208	5278	5345	5660
K82LH18LAU8RAU	8" Arms Left and Right		3485	3664	3804	3944	4096	4274	4376	4571	4733
			4901	5170	5708	6049	6122	6189	6273	6352	6728

DIMENSIONS

Width - L or R	35	Seat Height	18	Arm Height	22	Weight - L or R	50.50
Width - L and R	43	Seat Depth	21	Arm Depth	26	Weight - L and R	59.00
Depth	29	Seat Width	27	Arm Width	8	Cubic Ft. - L or R	15.10
Height	30					Cubic Ft. - L and R	17.00

- Contrasting fabric option – specify X (i.e., K82LH18LAUX); see page 488. For list pricing, use your electronic specification tool or contact customer service
- Arm options
- Kickrail power/USB
- Arm Power/USB
- Leg options

TO ORDER, SPECIFY

1. Model Number
2. Back Fabric Grade
3. Back Fabric Number
4. Seat Fabric Grade
5. Seat Fabric Number
6. Arm Fabric Grade
7. Arm Fabric Number
8. Arm Cap Finish Price Group (if applicable)
9. Arm Cap Finish Designator (if applicable)
10. Tech Tablet Laminate Price Group
11. Tech Tablet Laminate Designator
12. Kickrail Power/USB Option
13. Arm Power/USB Option
14. Leg Option

• See pages 485-487 for Pairings Health options
See pages 512-531 for COM fabric yardage

**ONE SEAT LOUNGE
TECH ARM LEFT**



2" Arm Right

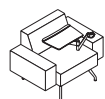

8" Arm Right

**MODEL
NO.**

ALLIANCE PROGRAM PRICE GRADES

			A	B	C	D	E	F	G	H	I
			J	K	L	M	N	O	P	Q	R
K82LH1TLAU		\$	3889	4039	4156	4274	4401	4551	4636	4800	4936
			5077	5303	5754	6040	6102	6158	6228	6295	6610
K82LH1TLAU2RAU	2" Arm Right		4348	4527	4667	4807	4959	5137	5239	5434	5596
			5764	6033	6571	6912	6985	7052	7136	7215	7591
K82LH1TLAU8RAU	8" Arm Right		4438	4617	4757	4897	5049	5227	5329	5524	5686
			5854	6123	6661	7002	7075	7142	7226	7305	7681

DIMENSIONS

Width	35	Seat Height	18	Arm Height	22	Weight	53.70
Depth	29	Seat Depth	21	Arm Depth	26	Cubic Ft.	15.10
Height	30	Seat Width	27	Arm Width	8		

DIMENSIONS - 2" ARM RIGHT

Width	37	Seat Height	18	Arm Height	22	Weight	64.30
Depth	29	Seat Depth	21	Arm Depth	26	Cubic Ft.	15.70
Height	30	Seat Width	27	Arm Width	8		

DIMENSIONS - 8" ARM RIGHT

Width	43	Seat Height	18	Arm Height	22	Weight	66.60
Depth	29	Seat Depth	21	Arm Depth	26	Cubic Ft.	17.00
Height	30	Seat Width	27	Arm Width	8		

- Contrasting fabric option – specify X (i.e., K82LH1TLAUX); see page 488. For list pricing, use your electronic specification tool or contact customer service
- Arm options
- Kickrail power/USB
- Arm power/USB
- Leg options

PAIRINGS HEALTH

TO ORDER, SPECIFY

1. Model Number
2. Back Fabric Grade
3. Back Fabric Number
4. Seat Fabric Grade
5. Seat Fabric Number
6. Arm Fabric Grade
7. Arm Fabric Number
8. Arm Cap Finish Price Group (if applicable)
9. Arm Cap Finish Designator (if applicable)
10. Tech Tablet Laminate Price Group
11. Tech Tablet Laminate Designator
12. Kickrail Power/USB Option
13. Arm Power/USB Option
14. Leg Option

• See pages 485-487 for Pairings Health options
See pages 512-531 for COM fabric yardage

ONE SEAT LOUNGE TECH ARM RIGHT



2" Arm Left



8" Arm Left

MODEL NO.

ALLIANCE PROGRAM PRICE GRADES

		ALLIANCE PROGRAM PRICE GRADES									
		A	B	C	D	E	F	G	H	I	
		J	K	L	M	N	O	P	Q	R	
K82LH1TRAU		\$ 3889	4039	4156	4274	4401	4551	4636	4800	4936	
		5077	5303	5754	6040	6102	6158	6228	6295	6610	
K82LH12LAUTRAU	2" Arm Left	4348	4527	4667	4807	4959	5137	5239	5434	5596	
		5764	6033	6571	6912	6985	7052	7136	7215	7591	
K82LH18LAUTRAU	8" Arm Left	4438	4617	4757	4897	5049	5227	5329	5524	5686	
		5854	6123	6661	7002	7075	7142	7226	7305	7681	

DIMENSIONS

Width	35	Seat Height	18	Arm Height	22	Weight	48.60
Depth	29	Seat Depth	21	Arm Depth	26	Cubic Ft.	15.10
Height	30	Seat Width	27	Arm Width	8		

DIMENSIONS - 2" ARM LEFT

Width	37	Seat Height	18	Arm Height	22	Weight	64.30
Depth	29	Seat Depth	21	Arm Depth	26	Cubic Ft.	15.70
Height	30	Seat Width	27	Arm Width	8		

DIMENSIONS - 8" ARM RIGHT

Width	43	Seat Height	18	Arm Height	22	Weight	66.60
Depth	29	Seat Depth	21	Arm Depth	26	Cubic Ft.	17.00
Height	30	Seat Width	27	Arm Width	8		

- Contrasting fabric option – specify X (i.e., K82LH1TRAUX); see page 488. For list pricing, use your electronic specification tool or contact customer service
- Arm options
- Kickrail power/USB
- Arm power/USB
- Leg options

TO ORDER, SPECIFY

1. Model Number
2. Back Fabric Grade
3. Back Fabric Number
4. Seat Fabric Grade
5. Seat Fabric Number
6. Arm Fabric Grade (2" or 8" arm only)
7. Arm Fabric Number (2" or 8" arm only)
8. Tech Tablet HPL Price Group
9. Tech Tablet HPL Designator
10. Storage TFL Designator
11. Kickrail Power/USB Option
12. Arm Power/USB Option
13. Leg Option

• See pages 485-487 for Pairings Health options
 See pages 512-531 for COM fabric yardage

**ONE SEAT LOUNGE
 TFL STORAGE
 TECH ARM LEFT**



2" Arm Right

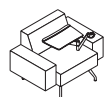

8" Arm Right

MODEL NO.

ALLIANCE PROGRAM PRICE GRADES

		A	B	C	D	E	F	G	H	I
		J	K	L	M	N	O	P	Q	R
K82LH1TLLLS	\$	3920	4038	4130	4223	4323	4441	4508	4637	4744
		4855	5033	5388	5613	5662	5706	5761	5814	6062
K82LH1TLLLS2RAU	2" Arm Right	4975	5125	5242	5360	5487	5637	5722	5886	6022
		6163	6389	6840	7126	7188	7244	7314	7381	7696
K82LH1TLLLS8RAU	8" Arm Right	5069	5219	5336	5454	5581	5731	5816	5980	6116
		6257	6483	6934	7220	7282	7338	7408	7475	7790

DIMENSIONS

Width	35	Seat Height	18	Arm Height	22	Weight	48.60
Depth	29	Seat Depth	21	Arm Depth	26	Cubic Ft.	15.10
Height	30	Seat Width	27	Arm Width	8		

DIMENSIONS - 2" ARM RIGHT

Width	37	Seat Height	18	Arm Height	22	Weight	64.30
Depth	29	Seat Depth	21	Arm Depth	26	Cubic Ft.	15.70
Height	30	Seat Width	27	Arm Width	8		

DIMENSIONS - 8" ARM RIGHT

Width	43	Seat Height	18	Arm Height	22	Weight	59.00
Depth	29	Seat Depth	21	Arm Depth	26	Cubic Ft.	17.00
Height	30	Seat Width	27	Arm Width	8		

- Contrasting fabric option – specify X (i.e., K82LH1TLLLSX); see page 489. For list pricing, use your electronic specification tool or contact customer service
- Kickrail power/USB
- Arm power/USB
- Leg options

PAIRINGS HEALTH

TO ORDER, SPECIFY

1. Model Number
2. Back Fabric Grade
3. Back Fabric Number
4. Seat Fabric Grade
5. Seat Fabric Number
6. Arm Fabric Grade (2" or 8" arm only)
7. Arm Fabric Number (2" or 8" arm only)
8. Tech Tablet HPL Price Group
9. Tech Tablet HPL Designator
10. Storage TFL Designator
11. Kickrail Power/USB Option
12. Arm Power/USB Option
13. Leg Option

• See pages 485-487 for Pairings Health options
See pages 512-531 for COM fabric yardage

ONE SEAT LOUNGE TFL STORAGE TECH ARM RIGHT

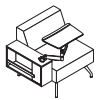

2" Arm Left



8" Arm Left

MODEL NO.

ALLIANCE PROGRAM PRICE GRADES

MODEL NO.		A	B	C	D	E	F	G	H	I
		J	K	L	M	N	O	P	Q	R
K82LH1TRLLS	\$	3920	4038	4130	4223	4323	4441	4508	4637	4744
		4855	5033	5388	5613	5662	5706	5761	5814	6062
K82LH12LAUTRLLS	2" Arm Left	4975	5125	5242	5360	5487	5637	5722	5886	6022
		6163	6389	6840	7126	7188	7244	7314	7381	7696
K82LH18LAUTRLLS	8" Arm Left	5069	5219	5336	5454	5581	5731	5816	5980	6116
		6257	6483	6934	7220	7282	7338	7408	7475	7790

DIMENSIONS

Width	35	Seat Height	18	Arm Height	22	Weight	48.60
Depth	29	Seat Depth	21	Arm Depth	26	Cubic Ft.	15.10
Height	30	Seat Width	27	Arm Width	8		

DIMENSIONS - 2" ARM LEFT

Width	37	Seat Height	18	Arm Height	22	Weight	64.30
Depth	29	Seat Depth	21	Arm Depth	26	Cubic Ft.	15.70
Height	30	Seat Width	27	Arm Width	8		

DIMENSIONS - 8" ARM LEFT

Width	43	Seat Height	18	Arm Height	22	Weight	59.00
Depth	29	Seat Depth	21	Arm Depth	26	Cubic Ft.	17.00
Height	30	Seat Width	27	Arm Width	8		

- Contrasting fabric option – specify X (i.e., H82LH1TRLLSX); see page 489. For list pricing, use your electronic specification tool or contact customer service
- Kickrail power/USB
- Arm power/USB
- Leg options

TO ORDER, SPECIFY

1. Model Number
2. Back Fabric Grade
3. Back Fabric Number
4. Seat Fabric Grade
5. Seat Fabric Number
6. Arm Fabric Grade (2" or 8" arm only)
7. Arm Fabric Number (2" or 8" arm only)
8. Tech Tablet HPL Price Group
9. Tech Tablet HPL Designator
10. Storage Wood Price Group
11. Storage Wood Finish Designator
12. Kickrail Power/USB Option
13. Arm Power/USB Option
14. Leg Option

• See pages 485-487 for Pairings Health options
See pages 512-531 for COM fabric yardage

**ONE SEAT LOUNGE
WOOD STORAGE
TECH ARM LEFT**



2" Arm Right



8" Arm Right

**MODEL
NO.**

ALLIANCE PROGRAM PRICE GRADES

		A	B	C	D	E	F	G	H	I
		J	K	L	M	N	O	P	Q	R
K82LH1TLWS	\$	4032	4150	4242	4335	4435	4553	4620	4749	4856
		4967	5145	5500	5725	5774	5818	5873	5926	6174
K82LH1TLWS2RAU	2" Arm Right	5118	5268	5385	5503	5630	5780	5865	6029	6165
		6306	6532	6983	7269	7331	7387	7457	7524	7839
K82LH1TLWS8RAU	8" Arm Right	5212	5362	5479	5597	5724	5874	5959	6123	6259
		6400	6626	7077	7363	7425	7481	7551	7618	7933

DIMENSIONS

Width	35	Seat Height	18	Arm Height	22	Weight	48.60
Depth	29	Seat Depth	21	Arm Depth	26	Cubic Ft.	15.10
Height	30	Seat Width	27	Arm Width	8		

DIMENSIONS - 2" ARM RIGHT

Width	37	Seat Height	18	Arm Height	22	Weight	64.30
Depth	29	Seat Depth	21	Arm Depth	26	Cubic Ft.	15.70
Height	30	Seat Width	27	Arm Width	8		

DIMENSIONS - 8" ARM RIGHT

Width	43	Seat Height	18	Arm Height	22	Weight	59.00
Depth	29	Seat Depth	21	Arm Depth	26	Cubic Ft.	17.00
Height	30	Seat Width	27	Arm Width	8		

- Contrasting fabric option – specify X (i.e., K82LH1TLWSX); see page 489. For list pricing, use your electronic specification tool or contact customer service
- Kickrail power/USB
- Arm power/USB
- Leg options

PAIRINGS HEALTH

TO ORDER, SPECIFY

1. Model Number
2. Back Fabric Grade
3. Back Fabric Number
4. Seat Fabric Grade
5. Seat Fabric Number
6. Arm Fabric Grade (2" or 8" arm only)
7. Arm Fabric Number (2" or 8" arm only)
8. Tech Tablet HPL Price Group
9. Tech Tablet HPL Designator
10. Storage Wood Price Group
11. Storage Wood Finish Designator
12. Kickrail Power/USB Option
13. Arm Power/USB Option
14. Leg Option

• See pages 485-487 for Pairings Health options

See pages 512-531 for COM fabric yardage

ONE SEAT LOUNGE WOOD STORAGE TECH ARM RIGHT



2" Arm Left



8" Arm Left

MODEL NO.

ALLIANCE PROGRAM PRICE GRADES

		A	B	C	D	E	F	G	H	I
		J	K	L	M	N	O	P	Q	R
K82LH1TRWS	\$	4032	4150	4242	4335	4435	4553	4620	4749	4856
		4967	5145	5500	5725	5774	5818	5873	5926	6174
K82LH12LAUTRWS	2" Arm Left	5118	5268	5385	5503	5630	5780	5865	6029	6165
		6306	6532	6983	7269	7331	7387	7457	7524	7839
K82LH18LAUTRWS	8" Arm Left	5212	5362	5479	5597	5724	5874	5959	6123	6259
		6400	6626	7077	7363	7425	7481	7551	7618	7933

DIMENSIONS

Width	35	Seat Height	18	Arm Height	22	Weight	48.60
Depth	29	Seat Depth	21	Arm Depth	26	Cubic Ft.	15.10
Height	30	Seat Width	27	Arm Width	8		

DIMENSIONS - 2" ARM LEFT

Width	37	Seat Height	18	Arm Height	22	Weight	64.30
Depth	29	Seat Depth	21	Arm Depth	26	Cubic Ft.	15.70
Height	30	Seat Width	27	Arm Width	8		

DIMENSIONS - 8" ARM RIGHT

Width	43	Seat Height	18	Arm Height	22	Weight	59.00
Depth	29	Seat Depth	21	Arm Depth	26	Cubic Ft.	17.00
Height	30	Seat Width	27	Arm Width	8		

- Contrasting fabric option – specify X (i.e., K82LH1TRWSX); see page 489. For list pricing, use your electronic specification tool or contact customer service
- Kickrail power/USB
- Arm power/USB
- Leg options

TO ORDER, SPECIFY

1. Model Number
2. Back Fabric Grade
3. Back Fabric Number
4. Seat Fabric Grade
5. Seat Fabric Number
6. Tablet HPL or Wood Price Group
(omit for 3D laminate)
7. Tablet Finish Designator
8. Storage TFL Designator
9. Kickrail Power/USB Option
10. Arm Power/USB Option
11. Leg Option

• See pages 485-487 for Pairings Health options
See pages 512-531 for COM fabric yardage

**ONE SEAT LOUNGE
TFL STORAGE
TABLET ARM LEFT**



3D Laminate Tablet



HPL Tablet with Phenolic Core



Wood Tablet

**MODEL
NO.**

ALLIANCE PROGRAM PRICE GRADES

			A	B	C	D	E	F	G	H	I
			J	K	L	M	N	O	P	Q	R
K82LH18LTLLS	3D Laminate Tablet	\$	4022	4140	4232	4325	4425	4543	4610	4739	4846
			4957	5135	5490	5715	5764	5808	5863	5916	6164
K82LH18LTLLS	HPL Tablet with Phenolic Core		4306	4424	4516	4609	4709	4827	4894	5023	5130
			5241	5419	5774	5999	6048	6092	6147	6200	6448
K82LH18LTWLLS	Wood Tablet		4321	4439	4531	4624	4724	4842	4909	5038	5145
			5256	5434	5789	6014	6063	6107	6162	6215	6463

DIMENSIONS

Width	37	Seat Height	18	Arm Height	22	Weight	48.60
Depth	29	Seat Depth	21	Arm Depth	26	Cubic Ft.	15.10
Height	30	Seat Width	27	Arm Width	8		

- Contrasting fabric option – specify X (i.e., K82LH18LTLLSX); see page 489. For list pricing, use your electronic specification tool or contact customer service
- Kickrail power/USB
- Arm power/USB
- Leg options

**ONE SEAT LOUNGE
TFL STORAGE
TABLET ARM RIGHT**

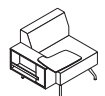

3D Laminate Tablet

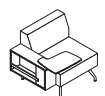

HPL Tablet with Phenolic Core



Wood Tablet

			A	B	C	D	E	F	G	H	I
			J	K	L	M	N	O	P	Q	R
K82LH18RTLLS	3D Laminate Tablet	\$	4022	4140	4232	4325	4425	4543	4610	4739	4846
			4957	5135	5490	5715	5764	5808	5863	5916	6164
K82LH18RTLLS	HPL Tablet with Phenolic Core		4306	4424	4516	4609	4709	4827	4894	5023	5130
			5241	5419	5774	5999	6048	6092	6147	6200	6448
K82LH18RTWLLS	Wood Tablet		4321	4439	4531	4624	4724	4842	4909	5038	5145
			5256	5434	5789	6014	6063	6107	6162	6215	6463

DIMENSIONS

Width	37	Seat Height	18	Arm Height	22	Weight	48.60
Depth	29	Seat Depth	21	Arm Depth	26	Cubic Ft.	15.10
Height	30	Seat Width	27	Arm Width	8		

- Contrasting fabric option – specify X (i.e., K82LH18RTLLSX); see page 489. For list pricing, use your electronic specification tool or contact customer service
- Kickrail power/USB
- Arm power/USB
- Leg options

PAIRINGS HEALTH

TO ORDER, SPECIFY

1. Model Number
2. Back Fabric Grade
3. Back Fabric Number
4. Seat Fabric Grade
5. Seat Fabric Number
6. Tablet HPL Price Group (HPL only)
7. Tablet Finish Designator (3D laminate and HPL only)
8. Storage Wood Price Group
9. Storage Wood Designator
10. Kickrail Power/USB Option
11. Arm Power/USB Option
12. Leg Option

• See pages 485-487 for Pairings Health options

See pages 512-531 for COM fabric yardage

ONE SEAT LOUNGE WOOD STORAGE TABLET ARM LEFT



3D Laminate Tablet



HPL Tablet with Phenolic Core



Wood Tablet

MODEL NO.

ALLIANCE PROGRAM PRICE GRADES

			A	B	C	D	E	F	G	H	I
			J	K	L	M	N	O	P	Q	R
			K82LH18LTTWS	3D Laminate Tablet	\$ 4163	4281	4373	4466	4566	4684	4751
			5098	5276	5631	5856	5905	5949	6004	6057	6305
K82LH18LTLWS	HPL Tablet with Phenolic Core	4448	4566	4658	4751	4851	4969	5036	5165	5272	
		5383	5561	5916	6141	6190	6234	6289	6342	6590	
K82LH18LTWWS	Wood Tablet	4463	4581	4673	4766	4866	4984	5051	5180	5287	
		5398	5576	5931	6156	6205	6249	6304	6357	6605	

DIMENSIONS

Width	37	Seat Height	18	Arm Height	22	Weight	48.60
Depth	29	Seat Depth	21	Arm Depth	26	Cubic Ft.	15.10
Height	30	Seat Width	27	Arm Width	8		

- Contrasting fabric option – specify X (i.e., K82LH18LTLWSX); see page 489. For list pricing, use your electronic specification tool or contact customer service
- Kickrail power/USB
- Arm power/USB
- Leg options

ONE SEAT LOUNGE WOOD STORAGE TABLET ARM RIGHT



3D Laminate Tablet



HPL Tablet with Phenolic Core



Wood Tablet

			A	B	C	D	E	F	G	H	I
			J	K	L	M	N	O	P	Q	R
			K82LH18RTTWS	3D Laminate Tablet	\$ 4163	4281	4373	4466	4566	4684	4751
			5098	5276	5631	5856	5905	5949	6004	6057	6305
K82LH18RTLWS	HPL Tablet with Phenolic Core	4448	4566	4658	4751	4851	4969	5036	5165	5272	
		5383	5561	5916	6141	6190	6234	6289	6342	6590	
K82LH18RTWWS	Wood Tablet	4463	4581	4673	4766	4866	4984	5051	5180	5287	
		5398	5576	5931	6156	6205	6249	6304	6357	6605	

DIMENSIONS

Width	37	Seat Height	18	Arm Height	22	Weight	48.60
Depth	29	Seat Depth	21	Arm Depth	26	Cubic Ft.	15.10
Height	30	Seat Width	27	Arm Width	8		

- Contrasting fabric option – specify X (i.e., K82LH18RTTWSX); see page 489. For list pricing, use your electronic specification tool or contact customer service
- Kickrail power/USB
- Arm power/USB
- Leg options

TO ORDER, SPECIFY

1. Model Number
2. Back Fabric Grade
3. Back Fabric Number
4. Seat Fabric Grade
5. Seat Fabric Number
6. Arm Fabric Grade
7. Arm Fabric Number
8. Arm Cap or Tablet Arm Finish Price Group (if applicable)
9. Arm Cap or Tablet Arm Finish Designator (if applicable)
10. Kickrail Power/USB Option
11. Leg Option

• See pages 485-487 for Pairings Health options
 See pages 512-531 for COM fabric yardage

**TWO SEAT LOUNGE
 2" ARMS**

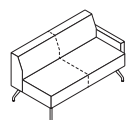

Left Arm

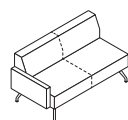

Right Arm

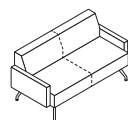

Left and Right Arms

**MODEL
 NO.**

ALLIANCE PROGRAM PRICE GRADES

			A	B	C	D	E	F	G	H	I
			J	K	L	M	N	O	P	Q	R
K82LH22LAU	2" Arm Left	\$	3775	3995	4167	4340	4527	4748	4872	5113	5313
			5520	5852	6513	6934	7025	7107	7210	7307	7770
K82LH22RAU	2" Arm Right		3775	3995	4167	4340	4527	4748	4872	5113	5313
			5520	5852	6513	6934	7025	7107	7210	7307	7770
K82LH22LAU2RAU	2" Arms Left and Right		4233	4482	4677	4872	5084	5333	5474	5746	5972
			6206	6581	7329	7805	7907	8000	8117	8226	8750

DIMENSIONS

Width - L or R	56	Seat Height	18	Arm Height	22	Weight - L or R	65.80
Width - L and R	58	Seat Depth	21	Arm Depth	26	Weight - L and R	71.40
Depth	29	Seat Width	54	Arm Width	2	Cubic Ft. - L or R	38.50
Height	30					Cubic Ft. - L and R	40.40

- Contrasting fabric option – specify X (i.e., K82LH22LAUX); see page 488. For list pricing, use your electronic specification tool or contact customer service
- Arm options
- Kickrail power/USB
- Leg options

PAIRINGS HEALTH

TO ORDER, SPECIFY

1. Model Number
2. Back Fabric Grade
3. Back Fabric Number
4. Seat Fabric Grade
5. Seat Fabric Number
6. Arm Fabric Grade
7. Arm Fabric Number
8. Arm Cap or Tablet Arm Finish Price Group (if applicable)
9. Arm Cap or Tablet Arm Finish Designator (if applicable)
10. Kickrail Power/USB Option
11. Arm Power/USB Option
12. Leg Option

• See pages 485-487 for Pairings Health options
See pages 512-531 for COM fabric yardage

TWO SEAT LOUNGE 8" ARMS

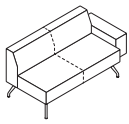

Left Arm

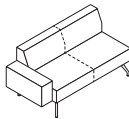

Right Arm

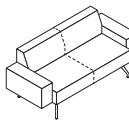

Left and Right Arms

MODEL NO.

ALLIANCE PROGRAM PRICE GRADES

			A	B	C	D	E	F	G	H	I
			J	K	L	M	N	O	P	Q	R
K82LH28LAU	8" Arm Left	\$	3868	4088	4260	4433	4620	4841	4965	5206	5406
			5613	5945	6606	7027	7118	7200	7303	7400	7863
K82LH28RAU	8" Arm Right		3868	4088	4260	4433	4620	4841	4965	5206	5406
			5613	5945	6606	7027	7118	7200	7303	7400	7863
K82LH28LAU8RAU	8" Arms Left and Right		4418	4667	4862	5057	5269	5518	5659	5931	6157
			6391	6766	7514	7990	8092	8185	8302	8411	8935

DIMENSIONS

Width - L or R	62	Seat Height	18	Arm Height	22	Weight - L or R	69.80
Width - L and R	70	Seat Depth	21	Arm Depth	26	Weight - L and R	79.40
Depth	29	Seat Width	54	Arm Width	8	Cubic Ft. - L or R	41.70
Height	30					Cubic Ft. - L and R	46.80

- Contrasting fabric option – specify X (i.e., K82LH28LAUX); see page 488. For list pricing, use your electronic specification tool or contact customer service
- Arm options
- Kickrail power/USB
- Arm power/USB
- Leg options

TO ORDER, SPECIFY

1. Model Number
2. Back Fabric Grade
3. Back Fabric Number
4. Seat Fabric Grade
5. Seat Fabric Number
6. Arm Fabric Grade
7. Arm Fabric Number
8. Arm Cap Finish Price Group
(if applicable)
9. Arm Cap Arm Finish Designator
(if applicable)
10. Tech Tablet Laminate Price Group
11. Tech Tablet Laminate Designator
12. Kickrail Power/USB Option
13. Arm Power/USB Option
14. Leg Option

• See pages 485-487 for Pairings Health options
See pages 512-531 for COM fabric yardage

**TWO SEAT LOUNGE
TECH ARM LEFT OR
BOTH SIDES**

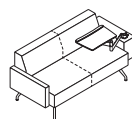

2" Arm Right

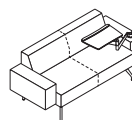

8" Arm Right

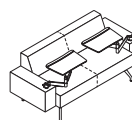

Both Sides

**MODEL
NO.**

ALLIANCE PROGRAM PRICE GRADES

		A	B	C	D	E	F	G	H	I
		J	K	L	M	N	O	P	Q	R
K82LH2TLAU		\$ 4823	5043	5215	5388	5575	5796	5920	6161	6361
		6568	6900	7561	7982	8073	8155	8258	8355	8818
K82LH2TLAU2RAU	2" Arm Right	5278	5527	5722	5917	6129	6378	6519	6791	7017
		7251	7626	8374	8850	8952	9045	9162	9271	9795
K82LH2TLAU8RAU	8" Arm Right	5370	5619	5814	6009	6221	6470	6611	6883	7109
		7343	7718	8466	8942	9044	9137	9254	9363	9887
K82LH2TLAU8RAU	Both Sides	6481	6730	6925	7120	7332	7581	7722	7994	8220
		8454	8829	9577	10053	10155	10248	10365	10474	10998

DIMENSIONS

Width	62	Seat Height	18	Arm Height	22	Weight	76.40
Depth	29	Seat Depth	21	Arm Depth	26	Cubic Ft.	41.70
Height	30	Seat Width	54	Arm Width	8		

DIMENSIONS - 2" ARM RIGHT

Width	64	Seat Height	18	Arm Height	22	Weight	81.00
Depth	29	Seat Depth	21	Arm Depth	26	Cubic Ft.	43.60
Height	30	Seat Width	54	Arm Width	8		

DIMENSIONS - 8" ARM RIGHT AND BOTH SIDES

Width	70	Seat Height	18	Arm Height	22	Weight	85.00
Depth	29	Seat Depth	21	Arm Depth	26	Cubic Ft.	46.80
Height	30	Seat Width	54	Arm Width	8		

- Contrasting fabric option – specify X (i.e., K82LH2TLAUX); see page 488. For list pricing, use your electronic specification tool or contact customer service
- Kickrail power/USB
- Arm power/USB
- Leg options

PAIRINGS HEALTH

TO ORDER, SPECIFY

1. Model Number
2. Back Fabric Grade
3. Back Fabric Number
4. Seat Fabric Grade
5. Seat Fabric Number
6. Arm Fabric Grade
7. Arm Fabric Number
8. Arm Cap Finish Price Group (if applicable)
9. Arm Cap Finish Designator (if applicable)
10. Tech Tablet Laminate Price Group
11. Tech Tablet Laminate Designator
12. Kickrail Power/USB Option
13. Arm Power/USB Option
14. Leg Option

• See pages 485-487 for Pairings Health options
See pages 512-531 for COM fabric yardage

TWO SEAT LOUNGE TECH ARM RIGHT

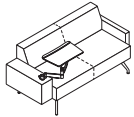
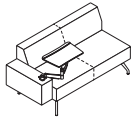

2" Arm Left

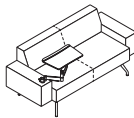

8" Arm Left

MODEL NO.

ALLIANCE PROGRAM PRICE GRADES

MODEL NO.		A	B	C	D	E	F	G	H	I
		J	K	L	M	N	O	P	Q	R
K82LH2TRAU		\$ 4823	5043	5215	5388	5575	5796	5920	6161	6361
		6568	6900	7561	7982	8073	8155	8258	8355	8818
K82LH22LAUTRAU	2" Arm Left	5278	5527	5722	5917	6129	6378	6519	6791	7017
		7251	7626	8374	8850	8952	9045	9162	9271	9795
K82LH28LAUTRAU	8" Arm Left	5370	5619	5814	6009	6221	6470	6611	6883	7109
		7343	7718	8466	8942	9044	9137	9254	9363	9887

DIMENSIONS

Width	62	Seat Height	18	Arm Height	22	Weight	76.40
Depth	29	Seat Depth	54	Arm Depth	26	Cubic Ft.	41.70
Height	30	Seat Width	27	Arm Width	8		

DIMENSIONS - 2" ARM LEFT

Width	64	Seat Height	18	Arm Height	22	Weight	81.00
Depth	29	Seat Depth	21	Arm Depth	26	Cubic Ft.	43.60
Height	30	Seat Width	54	Arm Width	8		

DIMENSIONS - 8" ARM LEFT

Width	70	Seat Height	18	Arm Height	22	Weight	85.00
Depth	29	Seat Depth	21	Arm Depth	26	Cubic Ft.	46.80
Height	30	Seat Width	54	Arm Width	8		

- Contrasting fabric option – specify X (i.e., K82LH2TRAUX); see page 488. For list pricing, use your electronic specification tool or contact customer service
- Kickrail power/USB
- Arm power/USB
- Leg options

TO ORDER, SPECIFY

1. Model Number
2. Back Fabric Grade
3. Back Fabric Number
4. Seat Fabric Grade
5. Seat Fabric Number
6. Arm Fabric Grade
7. Arm Fabric Number
8. Arm Cap or Tablet Arm Finish Price Group (if applicable)
9. Arm Cap or Tablet Arm Finish Designator (if applicable)
10. Kickrail Power/USB Option
11. Leg Option

• See pages 485-487 for Pairings Health options
See pages 512-531 for COM fabric yardage

**THREE SEAT LOUNGE
2" ARMS**

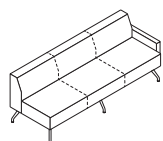

Left Arm

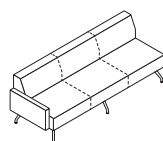

Right Arm

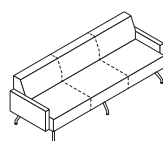

Left and Right Arms

**MODEL
NO.**

ALLIANCE PROGRAM PRICE GRADES

			A	B	C	D	E	F	G	H	I
			J	K	L	M	N	O	P	Q	R
K82LH32LAU	2" Arm Left	\$	5088	5399	5642	5884	6146	6456	6631	6970	7252
			7543	8008	8940	9531	9657	9774	9919	10055	10705
K82LH32RAU	2" Arm Right		5088	5399	5642	5884	6146	6456	6631	6970	7252
			7543	8008	8940	9531	9657	9774	9919	10055	10705
K82LH32LAU2RAU	2" Arms Left and Right		5546	5886	6152	6416	6703	7041	7233	7603	7911
			8229	8737	9756	10402	10539	10667	10826	10974	11685

DIMENSIONS

Width - L or R	83	Seat Height	18	Arm Height	22	Weight - L or R	91.30
Width - L and R	85	Seat Depth	21	Arm Depth	26	Weight - L and R	96.90
Depth	29	Seat Width	81	Arm Width	2	Cubic Ft. - L or R	56.20
Height	30					Cubic Ft. - L and R	58.10

- Contrasting fabric option – specify X (i.e., K82LH32LAUX); see page 488. For list pricing, use your electronic specification tool or contact customer service
- Arm options
- Kickrail power/USB
- Leg options

**THREE SEAT LOUNGE
8" ARMS**

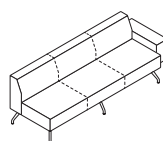

Left Arm

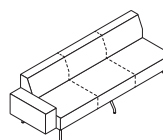

Right Arm

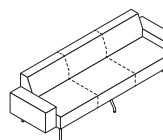

Left and Right Arms

			A	B	C	D	E	F	G	H	I
			J	K	L	M	N	O	P	Q	R
K82LH38LAU	8" Arm Left	\$	5180	5491	5734	5976	6238	6548	6723	7062	7344
			7635	8100	9032	9623	9749	9866	10011	10147	10797
K82LH38RAU	8" Arm Right		5180	5491	5734	5976	6238	6548	6723	7062	7344
			7635	8100	9032	9623	9749	9866	10011	10147	10797
K82LH38LAU8RAU	8" Arms Left and Right		5729	6069	6335	6599	6886	7224	7416	7786	8094
			8412	8920	9939	10585	10722	10850	11009	11157	11868

DIMENSIONS

Width - L or R	89	Seat Height	18	Arm Height	22	Weight - L or R	95.30
Width - L and R	97	Seat Depth	21	Arm Depth	26	Weight - L and R	104.90
Depth	29	Seat Width	81	Arm Width	2	Cubic Ft. - L or R	59.40
Height	30					Cubic Ft. - L and R	64.50

- Contrasting fabric option – specify X (i.e., K82LH38LAUX); see page 488. For list pricing, use your electronic specification tool or contact customer service
- Arm options
- Kickrail power/USB
- Leg options

PAIRINGS HEALTH

TO ORDER, SPECIFY

1. Model Number
2. Back Fabric Grade
3. Back Fabric Number
4. Seat Fabric Grade
5. Seat Fabric Number
6. Arm Fabric Grade
7. Arm Fabric Number
8. Arm Cap Finish Price Group (if applicable)
9. Arm Cap Finish Designator (if applicable)
10. Tech Tablet Laminate Price Group
11. Tech Tablet Laminate Designator
12. Kickrail Power/USB Option
13. Arm Power/USB Option
14. Leg Option

• See pages 485-487 for Pairings Health options
See pages 512-531 for COM fabric yardage

THREE SEAT LOUNGE TECH ARM LEFT OR BOTH SIDES

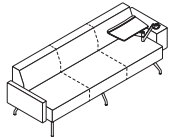
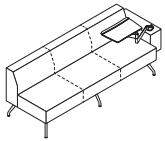

2" Arm Right

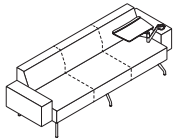

8" Arm Right

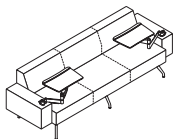

Both Sides

MODEL NO.

ALLIANCE PROGRAM PRICE GRADES

		A	B	C	D	E	F	G	H	I
		J	K	L	M	N	O	P	Q	R
K82LH3TLAU		\$ 6132	6443	6686	6928	7190	7500	7675	8014	8296
		8587	9052	9984	10575	10701	10818	10963	11099	11749
K82LH3TLAU2RAU	2" Arm Right	6589	6929	7195	7459	7746	8084	8276	8646	8954
		9272	9780	10799	11445	11582	11710	11869	12017	12728
K82LH3TLAU8RAU	8" Arm Right	6684	7024	7290	7554	7841	8179	8371	8741	9049
		9367	9875	10894	11540	11677	11805	11964	12112	12823
K82LH3TLAU8RAU	Both Sides	7823	8163	8429	8693	8980	9318	9510	9880	10188
		10506	11014	12033	12679	12816	12944	13103	13251	13962

DIMENSIONS

Width	89	Seat Height	18	Arm Height	22	Weight	100.90
Depth	29	Seat Depth	21	Arm Depth	26	Cubic Ft.	59.40
Height	30	Seat Width	81	Arm Width	8		

DIMENSIONS - 2" ARM RIGHT

Width	91	Seat Height	18	Arm Height	22	Weight	106.50
Depth	29	Seat Depth	21	Arm Depth	26	Cubic Ft.	61.30
Height	30	Seat Width	81	Arm Width	8		

DIMENSIONS - 8" ARM RIGHT AND BOTH SIDES

Width	97	Seat Height	18	Arm Height	22	Weight - 8" Arm Right	110.50
Depth	29	Seat Depth	21	Arm Depth	26	Weight - Both Sides	85.00
Height	30	Seat Width	81	Arm Width	8	Cubic Ft. - 8" Arm Right	64.50
						Cubic Ft. - Both Sides	46.80

- Contrasting fabric option – specify X (i.e., H82LH3TLAUX); see page 488. For list pricing, use your electronic specification tool or contact customer service
- Arm options
- Kickrail power/USB
- Arm power/USB
- Leg options

TO ORDER, SPECIFY

1. Model Number
2. Back Fabric Grade
3. Back Fabric Number
4. Seat Fabric Grade
5. Seat Fabric Number
6. Arm Fabric Grade
7. Arm Fabric Number
8. Arm Cap Finish Price Group (if applicable)
9. Arm Cap Finish Designator (if applicable)
10. Tech Tablet Laminate Price Group
11. Tech Tablet Laminate Designator
12. Kickrail Power/USB Option
13. Arm Power/USB Option
14. Leg Option

• See pages 485-487 for Pairings Health options
See pages 512-531 for COM fabric yardage

**THREE SEAT LOUNGE
TECH ARM RIGHT**

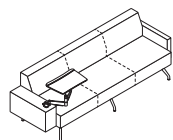
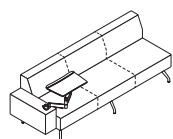

2" Arm Left

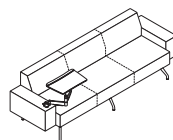

8" Arm Left

**MODEL
NO.**

ALLIANCE PROGRAM PRICE GRADES

		A	B	C	D	E	F	G	H	I
		J	K	L	M	N	O	P	Q	R
K82LH3TRAU		\$ 6132	6443	6686	6928	7190	7500	7675	8014	8296
		8587	9052	9984	10575	10701	10818	10963	11099	11749
K82LH32LAUTRAU	2" Arm Left	6589	6929	7195	7459	7746	8084	8276	8646	8954
		9272	9780	10799	11445	11582	11710	11869	12017	12728
K82LH38LAUTRAU	8" Arm Left	6684	7024	7290	7554	7841	8179	8371	8741	9049
		9367	9875	10894	11540	11677	11805	11964	12112	12823

DIMENSIONS

Width	89	Seat Height	18	Arm Height	22	Weight	100.90
Depth	29	Seat Depth	21	Arm Depth	26	Cubic Ft.	59.40
Height	30	Seat Width	81	Arm Width	8		

DIMENSIONS - 2" ARM LEFT

Width	91	Seat Height	18	Arm Height	22	Weight	106.50
Depth	29	Seat Depth	21	Arm Depth	26	Cubic Ft.	61.30
Height	30	Seat Width	81	Arm Width	8		

DIMENSIONS - 8" ARM LEFT

Width	97	Seat Height	18	Arm Height	22	Weight	110.50
Depth	29	Seat Depth	21	Arm Depth	26	Cubic Ft.	64.50
Height	30	Seat Width	81	Arm Width	8		

- Contrasting fabric option – specify X (i.e., K82LH3TRAUX); see page 488. For list pricing, use your electronic specification tool or contact customer service
- Arm options
- Kickrail power/USB
- Arm power/USB
- Leg options

PAIRINGS HEALTH

TO ORDER, SPECIFY

1. Model Number
2. Back Fabric Grade
3. Back Fabric Number
4. Seat Fabric Grade
5. Seat Fabric Number
6. Kickrail Power/USB Option (omit for corner)
7. Leg Option

• See pages 485-487 for Pairings Health options
See pages 512-531 for COM fabric yardage

CORNERS & CRESCENTS LOUNGE

MODEL NO.

ALLIANCE PROGRAM PRICE GRADES



90° Corner Left (as seated)



90° Corner Right (as seated)

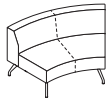

45° Crescent

			A	B	C	D	E	F	G	H	I
			J	K	L	M	N	O	P	Q	R
K82LH90L	90° Corner Left (as seated)	\$	2526	2623	2699	2774	2856	2953	3008	3114	3202
			3292	3438	3729	3914	3953	3989	4035	4078	4280
K82LH90R	90° Corner Right (as seated)		2526	2623	2699	2774	2856	2953	3008	3114	3202
			3292	3438	3729	3914	3953	3989	4035	4078	4280
K82LH45	45° Crescent		3169	3316	3431	3545	3669	3815	3898	4057	4191
			4328	4548	4987	5267	5327	5381	5450	5514	5821

DIMENSIONS - CORNER

Width	29	Seat Height	18	Weight	48.80
Depth	29	Seat Depth	21	Cubic Ft.	20.50
Height	30	Seat Width	29		

DIMENSIONS - CRESCENT

Width	54	Seat Height	18	Weight	77.30
Depth	29	Seat Depth	21	Cubic Ft.	40.90
Height	30	Seat Width	54		

- Corner and crescent lounge models coordinate with Pairings Health lounge models, but do not feature a clean-out.
- Can be used in conjunction with Kimball Pairings benches, tables, and perch models.
- Contrasting fabric option – specify X (i.e., K82LH90LX); see page 488. For list pricing, use your electronic specification tool or contact customer service
- No clean out
- Kickrail power/USB on crescent
- Leg options
- IMPORTANT: Fabrics reflect light differently when viewed at various angles, creating a natural phenomenon called "flip." Flip is visible on all fabrics and is not considered a defect; it is more easily recognized on fabrics with a nap or shimmer and more apparent on crescent or corner units

TO ORDER, SPECIFY

1. Model Number
2. Fabric Grade
3. Fabric Number
4. Kickrail Power/USB Option
5. Leg Option

• See pages 485-487 for Pairings Health options
 See pages 512-531 for COM fabric yardage

**BENCH
21" DEEP**



One Seat

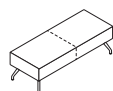

Two Seat

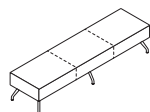

Three Seat

**MODEL
NO.**

ALLIANCE PROGRAM PRICE GRADES

				A	B	C	D	E	F	G	H	I
				J	K	L	M	N	O	P	Q	R
K82BH121	One Seat	\$	1892	1940	1977	2014	2055	2102	2129	2181	2224	
			2269	2340	2483	2574	2594	2611	2634	2655	2754	
K82BH221	Two Seat	2423	2510	2577	2645	2718	2805	2854	2949	3027		
		3109	3239	3499	3665	3700	3732	3773	3811	3993		
K82BH321	Three Seat	3132	3261	3361	3461	3569	3697	3769	3910	4026		
		4146	4338	4723	4967	5019	5067	5127	5183	5452		

DIMENSIONS - ONE SEAT

Width	27	Seat Height	18	Weight	
Depth	21	Seat Depth	21	Cubic Ft.	
Height	18	Seat Width	27		

DIMENSIONS - TWO SEAT

Width	54	Seat Height	18	Weight	
Depth	21	Seat Depth	21	Cubic Ft.	
Height	18	Seat Width	54		

DIMENSIONS - THREE SEAT

Width	81	Seat Height	18	Weight	
Depth	21	Seat Depth	21	Cubic Ft.	
Height	18	Seat Width	81		

- Kickrail power/USB
- Leg options

**BENCH
29" DEEP**



One Seat

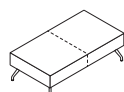

Two Seat

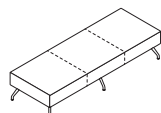

Three Seat

				A	B	C	D	E	F	G	H	I
				J	K	L	M	N	O	P	Q	R
K82BH129	One Seat	\$	2057	2131	2188	2246	2307	2381	2422	2502	2569	
			2638	2748	2968	3108	3138	3165	3200	3232	3386	
K82BH229	Two Seat	2667	2786	2878	2971	3071	3190	3257	3387	3494		
		3606	3784	4140	4367	4415	4459	4515	4567	4816		
K82BH329	Three Seat	3294	3463	3596	3729	3872	4042	4138	4324	4478		
		4637	4892	5402	5726	5795	5859	5938	6013	6369		

DIMENSIONS - ONE SEAT

Width	27	Seat Height	18	Weight	
Depth	29	Seat Depth	21	Cubic Ft.	
Height	18	Seat Width	27		

DIMENSIONS - TWO SEAT

Width	54	Seat Height	18	Weight	
Depth	29	Seat Depth	21	Cubic Ft.	
Height	18	Seat Width	54		

DIMENSIONS - THREE SEAT

Width	81	Seat Height	18	Weight	
Depth	29	Seat Depth	21	Cubic Ft.	
Height	18	Seat Width	81		

- Kickrail power/USB
- Leg options

PAIRINGS HEALTH

TO ORDER, SPECIFY

1. Model Number
2. Fabric Grade
3. Fabric Number
4. Leg Option

• See pages 485-487 for Pairings Health options
 See pages 512-531 for COM fabric yardage

90° CORNER BENCH



21" Deep



29" Deep

MODEL NO.

ALLIANCE PROGRAM PRICE GRADES

			A	B	C	D	E	F	G	H	I
			J	K	L	M	N	O	P	Q	R
K82BH9021L	21" Deep, Left (as seated)	\$	1727	1768	1801	1834	1869	1911	1935	1981	2019
			2058	2121	2247	2327	2344	2360	2379	2398	2486
K82BH9021R	21" Deep, Right (as seated)		1727	1768	1801	1834	1869	1911	1935	1981	2019
			2058	2121	2247	2327	2344	2360	2379	2398	2486
K82BH9029L	29" Deep, Left (as seated)		2289	2366	2425	2485	2550	2627	2670	2753	2823
			2895	3010	3239	3385	3417	3445	3481	3515	3675
K82BH9029R	29" Deep, Right (as seated)		2289	2366	2425	2485	2550	2627	2670	2753	2823
			2895	3010	3239	3385	3417	3445	3481	3515	3675

DIMENSIONS - 21" DEEP

Width	21	Seat Height	18	Weight
Depth	21	Seat Depth	21	Cubic Ft.
Height	18	Seat Width	21	

DIMENSIONS - 29" DEEP

Width	29	Seat Height	18	Weight
Depth	29	Seat Depth	29	Cubic Ft.
Height	18	Seat Width	29	

- Kickrail power/USB
- Leg options

TO ORDER, SPECIFY

1. Model Number
2. Fabric Grade
3. Fabric Number
4. Kickrail Power/USB option
5. Leg Option

• See pages 485-487 for Pairings Health options
 See pages 512-531 for COM fabric yardage

45° CRESCENT BENCH

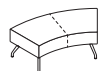

21" Deep

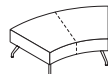

29" Deep

MODEL NO.

ALLIANCE PROGRAM PRICE GRADES

	MODEL NO.	SEAT DEPTH		A	B	C	D	E	F	G	H	I
				J	K	L	M	N	O	P	Q	R
K82BH4521	21" Deep	\$	2609	2674	2724	2774	2828	2892	2928	2999	3057	
			3117	3213	3406	3528	3554	3578	3608	3636	3771	
K82BH4529	29" Deep		3326	3403	3462	3522	3587	3664	3707	3790	3860	
			3932	4047	4276	4422	4454	4482	4518	4552	4712	

DIMENSIONS - 21" DEEP

Width	54	Seat Height	18	Weight	
Depth	21	Seat Depth	21	Cubic Ft.	
Height	18	Seat Width	54		

DIMENSIONS - 29" DEEP

Width	54	Seat Height	18	Weight	
Depth	29	Seat Depth	29	Cubic Ft.	
Height	18	Seat Width	54		

- Kickrail power/USB
- Leg options

COM YARDAGE REQUIREMENTS

COM YARDAGE REQUIREMENTS (54" WIDTH – CUT UP THE ROLL)

MODEL	RAILROADED Contact customer service 800-634-9510 for ydg requirements	NON DIRECTIONAL OR SOLID	1"-4" REPEAT	5"-11" REPEAT	12"-18" REPEAT	COL SQUARE FEET
			4" VERTICAL X 4" HORIZONTAL	11" VERTICAL X 11" HORIZONTAL	18" VERTICAL X 18" HORIZONTAL	
K82BH121	Entire Unit	1.40	1.90	2.10	3.20	28
K82BH129	Entire Unit	2.20	2.50	3.60	3.60	44
K82BH221	Entire Unit	2.60	2.90	4.50	4.70	52
K82BH229	Entire Unit	3.60	4.00	5.10	5.80	72
K82BH321	Entire Unit	3.50	3.90	5.10	5.70	70
K82BH329	Entire Unit	5.10	5.50	7.40	7.80	102
K82BH4521	Entire Unit	2.20	2.50	3.60	3.60	44
K82BH4529	Entire Unit	1.80	2.00	3.90	4.30	40
K82BH9021D	Entire Unit	1.30	1.50	2.10	3.20	26
K82BH9021L	Entire Unit	1.10	1.30	2.10	3.20	22
K82BH9021R	Entire Unit	1.10	1.30	2.10	3.20	22
K82BH9029D	Entire Unit	2.40	2.80	3.90	4.30	47.5
K82BH9029L	Entire Unit	2.20	2.50	3.60	3.60	44
K82BH9029R	Entire Unit	2.20	2.50	3.60	3.60	44
K82LH1	Entire Unit	2.50	3.10	3.90	4.80	49
	Back	1.40	1.70	2.10	3.30	28
	Seat	1.20	1.70	2.40	3.20	21.5
K82LH12LAP	Entire Unit	3.90	4.50	4.70	4.90	75.5
	Back	1.60	1.80	1.90	2.00	30.5
	Seat	2.10	2.40	2.50	2.60	38.2
	Arm	1.00	1.20	1.20	1.30	20
K82LH12LAP2RAP	Entire Unit	4.70	5.40	5.60	5.90	91.5
	Back	1.60	1.80	1.90	2.00	30.5
	Seat	2.10	2.40	2.50	2.60	38.2
	Arm	1.80	2.10	2.20	2.30	34
K82LH12LAS	Entire Unit	3.90	4.50	4.70	4.90	75.5
	Back	1.60	1.80	1.90	2.00	30.5
	Seat	2.10	2.40	2.50	2.60	38.2
	Arm	1.00	1.20	1.20	1.30	20
K82LH12LAS2RAS	Entire Unit	4.70	5.40	5.60	5.90	91.5
	Back	1.60	1.80	1.90	2.00	30.5
	Seat	2.10	2.40	2.50	2.60	38.2
	Arm	1.80	2.10	2.20	2.30	34
K82LH12LASTRAS	Entire Unit	4.80	5.50	5.80	6.00	94
	Back	1.60	1.80	1.90	2.00	30.5
	Seat	2.10	2.40	2.50	2.60	38.2
	Arm	1.90	2.20	2.30	2.40	38
K82LH12LAT	Entire Unit	3.90	4.50	4.70	4.90	75.5
	Back	1.60	1.80	1.90	2.00	30.5
	Seat	2.10	2.40	2.50	2.60	38.2
	Arm	1.00	1.20	1.20	1.30	20
K82LH12LAT2RAT	Entire Unit	4.70	5.40	5.60	5.90	91.5
	Back	1.60	1.80	1.90	2.00	30.5
	Seat	2.10	2.40	2.50	2.60	38.2
	Arm	1.80	2.10	2.20	2.30	34
K82LH12LAT2RTT	Entire Unit	4.70	5.40	5.60	5.90	91.5
	Back	1.60	1.80	1.90	2.00	30.5
	Seat	2.10	2.40	2.50	2.60	38.2
	Arm	1.80	2.10	2.20	2.30	34
K82LH12LATTRAT	Entire Unit	4.80	5.50	5.80	6.00	94
	Back	1.60	1.80	1.90	2.00	30.5
	Seat	2.10	2.40	2.50	2.60	38.2
	Arm	1.90	2.20	2.30	2.40	38
K82LH12LATTRLLS	Entire Unit	3.90	4.50	4.70	4.90	75.5
	Back	1.60	1.80	1.90	2.00	30.5
	Seat	2.10	2.40	2.50	2.60	38.2
	Arm	1.00	1.20	1.20	1.30	20

COM YARDAGE REQUIREMENTS

COM YARDAGE REQUIREMENTS (54" WIDTH – CUT UP THE ROLL)

MODEL	RAILROADED Contact customer service 800-634-9510 for ydg requirements	NON DIRECTIONAL OR SOLID	1"-4" REPEAT	5"-11" REPEAT	12"-18" REPEAT	COL SQUARE FEET
			4" VERTICAL X 4" HORIZONTAL	11" VERTICAL X 11" HORIZONTAL	18" VERTICAL X 18" HORIZONTAL	
K82LH12LAU	Entire Unit	3.90	4.50	4.70	4.90	75.5
	Back	1.60	1.80	1.90	2.00	30.5
	Seat	2.10	2.40	2.50	2.60	38.2
	Arm	1.00	1.20	1.20	1.30	20
K82LH12LAU2RAU	Entire Unit	4.80	5.50	5.80	6.00	92
	Back	1.60	1.80	1.90	2.00	30.5
	Seat	2.10	2.40	2.50	2.60	38.2
	Arm	1.90	2.20	2.30	2.40	36
K82LH12LAU2RTL	Entire Unit	4.80	5.50	5.80	6.00	92
	Back	1.60	1.80	1.90	2.00	30.5
	Seat	2.10	2.40	2.50	2.60	38.2
	Arm	1.90	2.20	2.30	2.40	36
K82LH12LAU2RTT	Entire Unit	4.80	5.50	5.80	6.00	92
	Back	1.60	1.80	1.90	2.00	30.5
	Seat	2.10	2.40	2.50	2.60	38.2
	Arm	1.90	2.20	2.30	2.40	36
K82LH12LAU2RTW	Entire Unit	4.80	5.50	5.80	6.00	92
	Back	1.60	1.80	1.90	2.00	30.5
	Seat	2.10	2.40	2.50	2.60	38.2
	Arm	1.90	2.20	2.30	2.40	36
K82LH12LAUTRAU	Entire Unit	4.80	5.50	5.80	6.00	94
	Back	1.60	1.80	1.90	2.00	30.5
	Seat	2.10	2.40	2.50	2.60	38.2
	Arm	1.90	2.20	2.30	2.40	38
K82LH12LAUTRLLS	Entire Unit	3.90	4.50	4.70	4.90	75.5
	Back	1.60	1.80	1.90	2.00	30.5
	Seat	2.10	2.40	2.50	2.60	38.2
	Arm	1.00	1.20	1.20	1.30	20
K82LH12LAUTRWS	Entire Unit	3.90	4.50	4.70	4.90	75.5
	Back	1.60	1.80	1.90	2.00	30.5
	Seat	2.10	2.40	2.50	2.60	38.2
	Arm	1.00	1.20	1.20	1.30	20
K82LH12LAW	Entire Unit	3.90	4.50	4.70	4.90	75.5
	Back	1.60	1.80	1.90	2.00	30.5
	Seat	2.10	2.40	2.50	2.60	38.2
	Arm	1.00	1.20	1.20	1.30	20
K82LH12LAW2RAW	Entire Unit	4.70	5.40	5.60	5.90	91.5
	Back	1.60	1.80	1.90	2.00	30.5
	Seat	2.10	2.40	2.50	2.60	38.2
	Arm	1.80	2.10	2.20	2.30	34
K82LH12LAW2RTW	Entire Unit	4.70	5.40	5.60	5.90	91.5
	Back	1.60	1.80	1.90	2.00	30.5
	Seat	2.10	2.40	2.50	2.60	38.2
	Arm	1.80	2.10	2.20	2.30	34
K82LH12LAWTRAW	Entire Unit	4.80	5.50	5.80	6.00	94
	Back	1.60	1.80	1.90	2.00	30.5
	Seat	2.10	2.40	2.50	2.60	38.2
	Arm	1.90	2.20	2.30	2.40	38
K82LH12LAWTRWS	Entire Unit	3.90	4.50	4.70	4.90	75.5
	Back	1.60	1.80	1.90	2.00	30.5
	Seat	2.10	2.40	2.50	2.60	38.2
	Arm	1.00	1.20	1.20	1.30	20
K82LH12LTL	Entire Unit	3.90	4.50	4.70	4.90	75.5
	Back	1.60	1.80	1.90	2.00	30.5
	Seat	2.10	2.40	2.50	2.60	38.2
	Arm	1.00	1.20	1.20	1.30	20
K82LH12LTL2RAU	Entire Unit	4.80	5.50	5.80	6.00	92
	Back	1.60	1.80	1.90	2.00	30.5
	Seat	2.10	2.40	2.50	2.60	38.2
	Arm	1.90	2.20	2.30	2.40	36

COM YARDAGE REQUIREMENTS

COM YARDAGE REQUIREMENTS (54" WIDTH – CUT UP THE ROLL)

MODEL	RAILROADED Contact customer service 800-634-9510 for ydg requirements	NON DIRECTIONAL OR SOLID	1"-4" REPEAT	5"-11" REPEAT	12"-18" REPEAT	COL SQUARE FEET
			4" VERTICAL X 4" HORIZONTAL	11" VERTICAL X 11" HORIZONTAL	18" VERTICAL X 18" HORIZONTAL	
K82LH12LTT	Entire Unit	3.90	4.50	4.70	4.90	75.5
	Back	1.60	1.80	1.90	2.00	30.5
	Seat	2.10	2.40	2.50	2.60	38.2
	Arm	1.00	1.20	1.20	1.30	20
K82LH12LTT2RAT	Entire Unit	4.70	5.40	5.60	5.90	91.5
	Back	1.60	1.80	1.90	2.00	30.5
	Seat	2.10	2.40	2.50	2.60	38.2
	Arm	1.80	2.10	2.20	2.30	34
K82LH12LTT2RAU	Entire Unit	4.80	5.50	5.80	6.00	92
	Back	1.60	1.80	1.90	2.00	30.5
	Seat	2.10	2.40	2.50	2.60	38.2
	Arm	1.90	2.20	2.30	2.40	36
K82LH12LTW	Entire Unit	3.90	4.50	4.70	4.90	75.5
	Back	1.60	1.80	1.90	2.00	30.5
	Seat	2.10	2.40	2.50	2.60	38.2
	Arm	1.00	1.20	1.20	1.30	20
K82LH12LTW2RAU	Entire Unit	4.80	5.50	5.80	6.00	92
	Back	1.60	1.80	1.90	2.00	30.5
	Seat	2.10	2.40	2.50	2.60	38.2
	Arm	1.90	2.20	2.30	2.40	36
K82LH12LTW2RAW	Entire Unit	4.70	5.40	5.60	5.90	91.5
	Back	1.60	1.80	1.90	2.00	30.5
	Seat	2.10	2.40	2.50	2.60	38.2
	Arm	1.80	2.10	2.20	2.30	34
K82LH12RAP	Entire Unit	3.90	4.50	4.70	4.90	75.5
	Back	1.60	1.80	1.90	2.00	30.5
	Seat	2.10	2.40	2.50	2.60	38.2
	Arm	1.00	1.20	1.20	1.30	20
K82LH12RAS	Entire Unit	3.90	4.50	4.70	4.90	75.5
	Back	1.60	1.80	1.90	2.00	30.5
	Seat	2.10	2.40	2.50	2.60	38.2
	Arm	1.00	1.20	1.20	1.30	20
K82LH12RAT	Entire Unit	3.90	4.50	4.70	4.90	75.5
	Back	1.60	1.80	1.90	2.00	30.5
	Seat	2.10	2.40	2.50	2.60	38.2
	Arm	1.00	1.20	1.20	1.30	20
K82LH12RAU	Entire Unit	3.90	4.50	4.70	4.90	75.5
	Back	1.60	1.80	1.90	2.00	30.5
	Seat	2.10	2.40	2.50	2.60	38.2
	Arm	1.00	1.20	1.20	1.30	20
K82LH12RAW	Entire Unit	3.90	4.50	4.70	4.90	75.5
	Back	1.60	1.80	1.90	2.00	30.5
	Seat	2.10	2.40	2.50	2.60	38.2
	Arm	1.00	1.20	1.20	1.30	20
K82LH12RTL	Entire Unit	3.90	4.50	4.70	4.90	75.5
	Back	1.60	1.80	1.90	2.00	30.5
	Seat	2.10	2.40	2.50	2.60	38.2
	Arm	1.00	1.20	1.20	1.30	20
K82LH12RTT	Entire Unit	3.90	4.50	4.70	4.90	75.5
	Back	1.60	1.80	1.90	2.00	30.5
	Seat	2.10	2.40	2.50	2.60	38.2
	Arm	1.00	1.20	1.20	1.30	20
K82LH12RTW	Entire Unit	3.90	4.50	4.70	4.90	75.5
	Back	1.60	1.80	1.90	2.00	30.5
	Seat	2.10	2.40	2.50	2.60	38.2
	Arm	1.00	1.20	1.20	1.30	20
K82LH18LAS	Entire Unit	3.90	4.50	4.70	4.90	75.5
	Back	1.60	1.80	1.90	2.00	30.5
	Seat	2.10	2.40	2.50	2.60	38.2
	Arm	1.00	1.20	1.20	1.30	20

COM YARDAGE REQUIREMENTS

COM YARDAGE REQUIREMENTS (54" WIDTH – CUT UP THE ROLL)

MODEL	RAILOADED Contact customer service 800-634-9510 for ydg requirements	NON DIRECTIONAL OR SOLID	1"-4" REPEAT	5"-11" REPEAT	12"-18" REPEAT	COL SQUARE FEET
			4" VERTICAL X 4" HORIZONTAL	11" VERTICAL X 11" HORIZONTAL	18" VERTICAL X 18" HORIZONTAL	
K82LH18LAS8RAS	Entire Unit	4.70	5.40	5.60	5.90	91.5
	Back	1.60	1.80	1.90	2.00	30.5
	Seat	2.10	2.40	2.50	2.60	38.2
	Arm	1.80	2.10	2.20	2.30	36
K82LH18LASTRAS	Entire Unit	4.70	5.40	5.60	5.90	91.5
	Back	1.60	1.80	1.90	2.00	30.5
	Seat	2.10	2.40	2.50	2.60	38.2
	Arm	1.80	2.10	2.20	2.30	36
K82LH18LAT	Entire Unit	3.90	4.50	4.70	4.90	75.5
	Back	1.60	1.80	1.90	2.00	30.5
	Seat	2.10	2.40	2.50	2.60	38.2
	Arm	1.00	1.20	1.20	1.30	20
K82LH18LAT8RAT	Entire Unit	4.70	5.40	5.60	5.90	91.5
	Back	1.60	1.80	1.90	2.00	30.5
	Seat	2.10	2.40	2.50	2.60	38.2
	Arm	1.80	2.10	2.20	2.30	36
K82LH18LAT8RTT	Entire Unit	4.70	5.40	5.60	5.90	91.5
	Back	1.60	1.80	1.90	2.00	30.5
	Seat	2.10	2.40	2.50	2.60	38.2
	Arm	1.80	2.10	2.20	2.30	36
K82LH18LATTRAT	Entire Unit	4.70	5.40	5.60	5.90	91.5
	Back	1.60	1.80	1.90	2.00	30.5
	Seat	2.10	2.40	2.50	2.60	38.2
	Arm	1.80	2.10	2.20	2.30	36
K82LH18LATRLLS	Entire Unit	3.90	4.50	4.70	4.90	75.5
	Back	1.60	1.80	1.90	2.00	30.5
	Seat	2.10	2.40	2.50	2.60	38.2
	Arm	1.00	1.20	1.20	1.30	20
K82LH18LAU	Entire Unit	3.90	4.50	4.70	4.90	75.5
	Back	1.60	1.80	1.90	2.00	30.5
	Seat	2.10	2.40	2.50	2.60	38.2
	Arm	1.00	1.20	1.20	1.30	20
K82LH18LAU8RAU	Entire Unit	4.80	5.50	5.80	6.00	94
	Back	1.60	1.80	1.90	2.00	30.5
	Seat	2.10	2.40	2.50	2.60	38.2
	Arm	1.90	2.20	2.30	2.40	36
K82LH18LAU8RTL	Entire Unit	4.80	5.50	5.80	6.00	94
	Back	1.60	1.80	1.90	2.00	30.5
	Seat	2.10	2.40	2.50	2.60	38.2
	Arm	1.90	2.20	2.30	2.40	36
K82LH18LAU8RTT	Entire Unit	4.80	5.50	5.80	6.00	94
	Back	1.60	1.80	1.90	2.00	30.5
	Seat	2.10	2.40	2.50	2.60	38.2
	Arm	1.90	2.20	2.30	2.40	36
K82LH18LAU8RTW	Entire Unit	4.80	5.50	5.80	6.00	94
	Back	1.60	1.80	1.90	2.00	30.5
	Seat	2.10	2.40	2.50	2.60	38.2
	Arm	1.90	2.20	2.30	2.40	36
K82LH18LAUTRAU	Entire Unit	4.80	5.50	5.80	6.00	94
	Back	1.60	1.80	1.90	2.00	30.5
	Seat	2.10	2.40	2.50	2.60	38.2
	Arm	1.90	2.20	2.30	2.40	36
K82LH18LAUTRLLS	Entire Unit	3.90	4.50	4.70	4.90	75.5
	Back	1.60	1.80	1.90	2.00	30.5
	Seat	2.10	2.40	2.50	2.60	38.2
	Arm	1.00	1.20	1.20	1.30	20
K82LH18LAUTRWS	Entire Unit	3.90	4.50	4.70	4.90	75.5
	Back	1.60	1.80	1.90	2.00	30.5
	Seat	2.10	2.40	2.50	2.60	38.2
	Arm	1.00	1.20	1.20	1.30	20

COM YARDAGE REQUIREMENTS

COM YARDAGE REQUIREMENTS (54" WIDTH – CUT UP THE ROLL)

MODEL	RAILROADED Contact customer service 800-634-9510 for ydg requirements	NON DIRECTIONAL OR SOLID	1"-4" REPEAT	5"-11" REPEAT	12"-18" REPEAT	COL SQUARE FEET
			4" VERTICAL X 4" HORIZONTAL	11" VERTICAL X 11" HORIZONTAL	18" VERTICAL X 18" HORIZONTAL	
K82LH18LAW	Entire Unit	3.90	4.50	4.70	4.90	75.5
	Back	1.60	1.80	1.90	2.00	30.5
	Seat	2.10	2.40	2.50	2.60	38.2
	Arm	1.00	1.20	1.20	1.30	20
K82LH18LAW8RAW	Entire Unit	4.70	5.40	5.60	5.90	91.5
	Back	1.60	1.80	1.90	2.00	30.5
	Seat	2.10	2.40	2.50	2.60	38.2
	Arm	1.80	2.10	2.20	2.30	36
K82LH18LAW8RTW	Entire Unit	4.70	5.40	5.60	5.90	91.5
	Back	1.60	1.80	1.90	2.00	30.5
	Seat	2.10	2.40	2.50	2.60	38.2
	Arm	1.80	2.10	2.20	2.30	36
K82LH18LAWTRAW	Entire Unit	4.70	5.40	5.60	5.90	91.5
	Back	1.60	1.80	1.90	2.00	30.5
	Seat	2.10	2.40	2.50	2.60	38.2
	Arm	1.80	2.10	2.20	2.30	36
K82LH18LAWTRWS	Entire Unit	3.90	4.50	4.70	4.90	75.5
	Back	1.60	1.80	1.90	2.00	30.5
	Seat	2.10	2.40	2.50	2.60	38.2
	Arm	1.00	1.20	1.20	1.30	20
K82LH18LTL	Entire Unit	3.90	4.50	4.70	4.90	75.5
	Back	1.60	1.80	1.90	2.00	30.5
	Seat	2.10	2.40	2.50	2.60	38.2
	Arm	1.00	1.20	1.20	1.30	20
K82LH18LTL8RAU	Entire Unit	4.80	5.50	5.80	6.00	94
	Back	1.60	1.80	1.90	2.00	30.5
	Seat	2.10	2.40	2.50	2.60	38.2
	Arm	1.90	2.20	2.30	2.40	36
K82LH18LTL LLS	Entire Unit	3.00	3.50	3.60	3.80	57
	Back	1.60	1.80	1.90	2.00	30.5
	Seat	2.10	2.40	2.50	2.60	38.2
K82LH18LTLWS	Entire Unit	3.00	3.50	3.60	3.80	57
	Back	1.60	1.80	1.90	2.00	30.5
	Seat	2.10	2.40	2.50	2.60	38.2
K82LH18LTT	Entire Unit	3.90	4.50	4.70	4.90	75.5
	Back	1.60	1.80	1.90	2.00	30.5
	Seat	2.10	2.40	2.50	2.60	38.2
	Arm	1.00	1.20	1.20	1.30	20
K82LH18LTT8RAT	Entire Unit	4.70	5.40	5.60	5.90	91.5
	Back	1.60	1.80	1.90	2.00	30.5
	Seat	2.10	2.40	2.50	2.60	38.2
	Arm	1.80	2.10	2.20	2.30	36
K82LH18LTT8RAU	Entire Unit	4.80	5.50	5.80	6.00	94
	Back	1.60	1.80	1.90	2.00	30.5
	Seat	2.10	2.40	2.50	2.60	38.2
	Arm	1.90	2.20	2.30	2.40	36
K82LH18LTT LLS	Entire Unit	3.00	3.50	3.60	3.80	57
	Back	1.60	1.80	1.90	2.00	30.5
	Seat	2.10	2.40	2.50	2.60	38.2
K82LH18LTTWS	Entire Unit	3.00	3.50	3.60	3.80	57
	Back	1.60	1.80	1.90	2.00	30.5
	Seat	2.10	2.40	2.50	2.60	38.2
K82LH18LTW	Entire Unit	3.90	4.50	4.70	4.90	75.5
	Back	1.60	1.80	1.90	2.00	30.5
	Seat	2.10	2.40	2.50	2.60	38.2
	Arm	1.00	1.20	1.20	1.30	20
K82LH18LTW8RAU	Entire Unit	4.80	5.50	5.80	6.00	94
	Back	1.60	1.80	1.90	2.00	30.5
	Seat	2.10	2.40	2.50	2.60	38.2
	Arm	1.90	2.20	2.30	2.40	36

COM YARDAGE REQUIREMENTS

COM YARDAGE REQUIREMENTS (54" WIDTH – CUT UP THE ROLL)

MODEL	RAILOADED Contact customer service 800-634-9510 for ydg requirements	NON DIRECTIONAL OR SOLID	1"-4" REPEAT	5"-11" REPEAT	12"-18" REPEAT	COL SQUARE FEET
			4" VERTICAL X 4" HORIZONTAL	11" VERTICAL X 11" HORIZONTAL	18" VERTICAL X 18" HORIZONTAL	
K82LH18LTW8RAW	Entire Unit	4.70	5.40	5.60	5.90	91.5
	Back	1.60	1.80	1.90	2.00	30.5
	Seat	2.10	2.40	2.50	2.60	38.2
	Arm	1.80	2.10	2.20	2.30	36
K82LH18LTWLLS	Entire Unit	3.00	3.50	3.60	3.80	57
	Back	1.60	1.80	1.90	2.00	30.5
	Seat	2.10	2.40	2.50	2.60	38.2
K82LH18LTWWS	Entire Unit	3.00	3.50	3.60	3.80	57
	Back	1.60	1.80	1.90	2.00	30.5
	Seat	2.10	2.40	2.50	2.60	38.2
K82LH18RAS	Entire Unit	3.90	4.50	4.70	4.90	75.5
	Back	1.60	1.80	1.90	2.00	30.5
	Seat	2.10	2.40	2.50	2.60	38.2
	Arm	1.00	1.20	1.20	1.30	20
K82LH18RAT	Entire Unit	3.90	4.50	4.70	4.90	75.5
	Back	1.60	1.80	1.90	2.00	30.5
	Seat	2.10	2.40	2.50	2.60	38.2
	Arm	1.00	1.20	1.20	1.30	20
K82LH18RAU	Entire Unit	3.90	4.50	4.70	4.90	75.5
	Back	1.60	1.80	1.90	2.00	30.5
	Seat	2.10	2.40	2.50	2.60	38.2
	Arm	1.00	1.20	1.20	1.30	20
K82LH18RAW	Entire Unit	3.90	4.50	4.70	4.90	75.5
	Back	1.60	1.80	1.90	2.00	30.5
	Seat	2.10	2.40	2.50	2.60	38.2
	Arm	1.00	1.20	1.20	1.30	20
K82LH18RTL	Entire Unit	3.90	4.50	4.70	4.90	75.5
	Back	1.60	1.80	1.90	2.00	30.5
	Seat	2.10	2.40	2.50	2.60	38.2
	Arm	1.00	1.20	1.20	1.30	20
K82LH18RTLCLS	Entire Unit	3.00	3.50	3.60	3.80	57
	Back	1.60	1.80	1.90	2.00	30.5
	Seat	2.10	2.40	2.50	2.60	38.2
K82LH18RTLWS	Entire Unit	3.00	3.50	3.60	3.80	57
	Back	1.60	1.80	1.90	2.00	30.5
	Seat	2.10	2.40	2.50	2.60	38.2
K82LH18RTT	Entire Unit	3.90	4.50	4.70	4.90	75.5
	Back	1.60	1.80	1.90	2.00	30.5
	Seat	2.10	2.40	2.50	2.60	38.2
	Arm	1.00	1.20	1.20	1.30	20
K82LH18RTTCLS	Entire Unit	3.00	3.50	3.60	3.80	57
	Back	1.60	1.80	1.90	2.00	30.5
	Seat	2.10	2.40	2.50	2.60	38.2
K82LH18RTTWS	Entire Unit	3.00	3.50	3.60	3.80	57
	Back	1.60	1.80	1.90	2.00	30.5
	Seat	2.10	2.40	2.50	2.60	38.2
K82LH18RTW	Entire Unit	3.90	4.50	4.70	4.90	75.5
	Back	1.60	1.80	1.90	2.00	30.5
	Seat	2.10	2.40	2.50	2.60	38.2
	Arm	1.00	1.20	1.20	1.30	20
K82LH18RTWCLS	Entire Unit	3.00	3.50	3.60	3.80	57
	Back	1.60	1.80	1.90	2.00	30.5
	Seat	2.10	2.40	2.50	2.60	38.2
K82LH18RTWWS	Entire Unit	3.00	3.50	3.60	3.80	57
	Back	1.60	1.80	1.90	2.00	30.5
	Seat	2.10	2.40	2.50	2.60	38.2
K82LH1TLAS	Entire Unit	3.90	4.50	4.70	4.90	75.5
	Back	1.60	1.80	1.90	2.00	30.5
	Seat	2.10	2.40	2.50	2.60	38.2
	Arm	1.00	1.20	1.20	1.30	20

COM YARDAGE REQUIREMENTS

COM YARDAGE REQUIREMENTS (54" WIDTH – CUT UP THE ROLL)

MODEL	RAILROADED Contact customer service 800-634-9510 for ydg requirements	NON DIRECTIONAL OR SOLID	1"-4" REPEAT	5"-11" REPEAT	12"-18" REPEAT	COL SQUARE FEET
			4" VERTICAL X 4" HORIZONTAL	11" VERTICAL X 11" HORIZONTAL	18" VERTICAL X 18" HORIZONTAL	
K82LH1TLAS2RAS	Entire Unit	4.80	5.50	5.80	6.00	94
	Back	1.60	1.80	1.90	2.00	30.5
	Seat	2.10	2.40	2.50	2.60	38.2
	Arm	1.90	2.20	2.30	2.40	38
K82LH1TLAS8RAS	Entire Unit	4.70	5.40	5.60	5.90	91.5
	Back	1.60	1.80	1.90	2.00	30.5
	Seat	2.10	2.40	2.50	2.60	38.2
	Arm	1.80	2.10	2.20	2.30	36
K82LH1TLAT	Entire Unit	3.90	4.50	4.70	4.90	75.5
	Back	1.60	1.80	1.90	2.00	30.5
	Seat	2.10	2.40	2.50	2.60	38.2
	Arm	1.00	1.20	1.20	1.30	20
K82LH1TLAT2RAT	Entire Unit	4.80	5.50	5.80	6.00	94
	Back	1.60	1.80	1.90	2.00	30.5
	Seat	2.10	2.40	2.50	2.60	38.2
	Arm	1.90	2.20	2.30	2.40	38
K82LH1TLAT8RAT	Entire Unit	4.70	5.40	5.60	5.90	91.5
	Back	1.60	1.80	1.90	2.00	30.5
	Seat	2.10	2.40	2.50	2.60	38.2
	Arm	1.80	2.10	2.20	2.30	36
K82LH1TLAU	Entire Unit	3.90	4.50	4.70	4.90	75.5
	Back	1.60	1.80	1.90	2.00	30.5
	Seat	2.10	2.40	2.50	2.60	38.2
	Arm	1.00	1.20	1.20	1.30	20
K82LH1TLAU2RAU	Entire Unit	4.80	5.50	5.80	6.00	94
	Back	1.60	1.80	1.90	2.00	30.5
	Seat	2.10	2.40	2.50	2.60	38.2
	Arm	1.90	2.20	2.30	2.40	38
K82LH1TLAU8RAU	Entire Unit	4.80	5.50	5.80	6.00	94
	Back	1.60	1.80	1.90	2.00	30.5
	Seat	2.10	2.40	2.50	2.60	38.2
	Arm	1.90	2.20	2.30	2.40	36
K82LH1TLAW	Entire Unit	3.90	4.50	4.70	4.90	75.5
	Back	1.60	1.80	1.90	2.00	30.5
	Seat	2.10	2.40	2.50	2.60	38.2
	Arm	1.00	1.20	1.20	1.30	20
K82LH1TLAW2RAW	Entire Unit	4.80	5.50	5.80	6.00	94
	Back	1.60	1.80	1.90	2.00	30.5
	Seat	2.10	2.40	2.50	2.60	38.2
	Arm	1.90	2.20	2.30	2.40	38
K82LH1TLAW8RAW	Entire Unit	4.70	5.40	5.60	5.90	91.5
	Back	1.60	1.80	1.90	2.00	30.5
	Seat	2.10	2.40	2.50	2.60	38.2
	Arm	1.80	2.10	2.20	2.30	36
K82LH1TLLLS	Entire Unit	3.00	3.50	3.60	3.80	57
	Back	1.60	1.80	1.90	2.00	30.5
	Seat	2.10	2.40	2.50	2.60	38.2
K82LH1TLLLS2RAT	Entire Unit	3.90	4.50	4.70	4.90	75.5
	Back	1.60	1.80	1.90	2.00	30.5
	Seat	2.10	2.40	2.50	2.60	38.2
	Arm	1.00	1.20	1.20	1.30	20
K82LH1TLLLS2RAU	Entire Unit	3.90	4.50	4.70	4.90	75.5
	Back	1.60	1.80	1.90	2.00	30.5
	Seat	2.10	2.40	2.50	2.60	38.2
	Arm	1.00	1.20	1.20	1.30	20
K82LH1TLLLS8RAT	Entire Unit	3.90	4.50	4.70	4.90	75.5
	Back	1.60	1.80	1.90	2.00	30.5
	Seat	2.10	2.40	2.50	2.60	38.2
	Arm	1.00	1.20	1.20	1.30	20

COM YARDAGE REQUIREMENTS

COM YARDAGE REQUIREMENTS (54" WIDTH – CUT UP THE ROLL)

MODEL	RAILOADED Contact customer service 800-634-9510 for ydg requirements	NON DIRECTIONAL OR SOLID	1"-4" REPEAT	5"-11" REPEAT	12"-18" REPEAT	COL SQUARE FEET
			4" VERTICAL X 4" HORIZONTAL	11" VERTICAL X 11" HORIZONTAL	18" VERTICAL X 18" HORIZONTAL	
K82LH1TLLOS8RAU	Entire Unit	3.90	4.50	4.70	4.90	75.5
	Back	1.60	1.80	1.90	2.00	30.5
	Seat	2.10	2.40	2.50	2.60	38.2
	Arm	1.00	1.20	1.20	1.30	20
K82LH1TLWS	Entire Unit	3.00	3.50	3.60	3.80	57
	Back	1.60	1.80	1.90	2.00	30.5
	Seat	2.10	2.40	2.50	2.60	38.2
K82LH1TLWS2RAU	Entire Unit	3.90	4.50	4.70	4.90	75.5
	Back	1.60	1.80	1.90	2.00	30.5
	Seat	2.10	2.40	2.50	2.60	38.2
	Arm	1.00	1.20	1.20	1.30	20
K82LH1TLWS2RAW	Entire Unit	3.90	4.50	4.70	4.90	75.5
	Back	1.60	1.80	1.90	2.00	30.5
	Seat	2.10	2.40	2.50	2.60	38.2
	Arm	1.00	1.20	1.20	1.30	20
K82LH1TLWS8RAU	Entire Unit	3.90	4.50	4.70	4.90	75.5
	Back	1.60	1.80	1.90	2.00	30.5
	Seat	2.10	2.40	2.50	2.60	38.2
	Arm	1.00	1.20	1.20	1.30	20
K82LH1TLWS8RAW	Entire Unit	3.90	4.50	4.70	4.90	75.5
	Back	1.60	1.80	1.90	2.00	30.5
	Seat	2.10	2.40	2.50	2.60	38.2
	Arm	1.00	1.20	1.20	1.30	20
K82LH1TRAS	Entire Unit	3.90	4.50	4.70	4.90	75.5
	Back	1.60	1.80	1.90	2.00	30.5
	Seat	2.10	2.40	2.50	2.60	38.2
	Arm	1.00	1.20	1.20	1.30	20
K82LH1TRAT	Entire Unit	3.90	4.50	4.70	4.90	75.5
	Back	1.60	1.80	1.90	2.00	30.5
	Seat	2.10	2.40	2.50	2.60	38.2
	Arm	1.00	1.20	1.20	1.30	20
K82LH1TRAU	Entire Unit	3.90	4.50	4.70	4.90	75.5
	Back	1.60	1.80	1.90	2.00	30.5
	Seat	2.10	2.40	2.50	2.60	38.2
	Arm	1.00	1.20	1.20	1.30	20
K82LH1TRAW	Entire Unit	3.90	4.50	4.70	4.90	75.5
	Back	1.60	1.80	1.90	2.00	30.5
	Seat	2.10	2.40	2.50	2.60	38.2
	Arm	1.00	1.20	1.20	1.30	20
K82LH1TRLLS	Entire Unit	3.00	3.50	3.60	3.80	57
	Back	1.60	1.80	1.90	2.00	30.5
	Seat	2.10	2.40	2.50	2.60	38.2
K82LH1TRWS	Entire Unit	3.00	3.50	3.60	3.80	57
	Back	1.60	1.80	1.90	2.00	30.5
	Seat	2.10	2.40	2.50	2.60	38.2
K82LH2	Entire Unit	5.80	6.70	7.00	7.30	112.4
	Back	3.10	3.60	3.70	3.90	60.4
	Seat	2.80	3.20	3.40	3.50	53.2
K82LH22LAP	Entire Unit	6.70	7.70	8.00	8.40	130.9
	Back	3.10	3.60	3.70	3.90	60.4
	Seat	2.80	3.20	3.40	3.50	53.2
	Arm	1.00	1.20	1.20	1.30	20
K82LH22LAP2RAP	Entire Unit	7.50	8.60	9.00	9.40	145.9
	Back	3.10	3.60	3.70	3.90	60.4
	Seat	2.80	3.20	3.40	3.50	53.2
	Arm	1.80	2.10	2.20	2.30	34
K82LH22LAS	Entire Unit	6.70	7.70	8.00	8.40	130.9
	Back	3.10	3.60	3.70	3.90	60.4
	Seat	2.80	3.20	3.40	3.50	53.2
	Arm	1.00	1.20	1.20	1.30	20

COM YARDAGE REQUIREMENTS

COM YARDAGE REQUIREMENTS (54" WIDTH – CUT UP THE ROLL)

MODEL	RAILROADED Contact customer service 800-634-9510 for ydg requirements	NON DIRECTIONAL OR SOLID	1"-4" REPEAT	5"-11" REPEAT	12"-18" REPEAT	COL SQUARE FEET
			4" VERTICAL X 4" HORIZONTAL	11" VERTICAL X 11" HORIZONTAL	18" VERTICAL X 18" HORIZONTAL	
K82LH22LAS2RAS	Entire Unit	7.50	8.60	9.00	9.40	145.9
	Back	3.10	3.60	3.70	3.90	60.4
	Seat	2.80	3.20	3.40	3.50	53.2
	Arm	1.80	2.10	2.20	2.30	34
K82LH22LASTRAS	Entire Unit	7.50	8.60	9.00	9.40	145.9
	Back	3.10	3.60	3.70	3.90	60.4
	Seat	2.80	3.20	3.40	3.50	53.2
	Arm	1.90	2.20	2.30	2.40	38
K82LH22LAT	Entire Unit	6.70	7.70	8.00	8.40	130.9
	Back	3.10	3.60	3.70	3.90	60.4
	Seat	2.80	3.20	3.40	3.50	53.2
	Arm	1.00	1.20	1.20	1.30	20
K82LH22LAT2RAT	Entire Unit	7.50	8.60	9.00	9.40	145.9
	Back	3.10	3.60	3.70	3.90	60.4
	Seat	2.80	3.20	3.40	3.50	53.2
	Arm	1.80	2.10	2.20	2.30	34
K82LH22LAT2RTT	Entire Unit	7.50	8.60	9.00	9.40	145.9
	Back	3.10	3.60	3.70	3.90	60.4
	Seat	2.80	3.20	3.40	3.50	53.2
	Arm	1.80	2.10	2.20	2.30	34
K82LH22LATTRAT	Entire Unit	7.50	8.60	9.00	9.40	145.9
	Back	3.10	3.60	3.70	3.90	60.4
	Seat	2.80	3.20	3.40	3.50	53.2
	Arm	1.90	2.20	2.30	2.40	38
K82LH22LAU	Entire Unit	6.70	7.70	8.00	8.40	130.9
	Back	3.10	3.60	3.70	3.90	60.4
	Seat	2.80	3.20	3.40	3.50	53.2
	Arm	1.00	1.20	1.20	1.30	20
K82LH22LAU2RAU	Entire Unit	7.60	8.70	9.10	9.50	148.4
	Back	3.10	3.60	3.70	3.90	60.4
	Seat	2.80	3.20	3.40	3.50	53.2
	Arm	1.90	2.20	2.30	2.40	36
K82LH22LAU2RTL	Entire Unit	7.60	8.70	9.10	9.50	148.4
	Back	3.10	3.60	3.70	3.90	60.4
	Seat	2.80	3.20	3.40	3.50	53.2
	Arm	1.90	2.20	2.30	2.40	36
K82LH22LAU2RTT	Entire Unit	7.60	8.70	9.10	9.50	148.4
	Back	3.10	3.60	3.70	3.90	60.4
	Seat	2.80	3.20	3.40	3.50	53.2
	Arm	1.90	2.20	2.30	2.40	36
K82LH22LAU2RTW	Entire Unit	7.60	8.70	9.10	9.50	148.4
	Back	3.10	3.60	3.70	3.90	60.4
	Seat	2.80	3.20	3.40	3.50	53.2
	Arm	1.90	2.20	2.30	2.40	36
K82LH22LAUTRAU	Entire Unit	7.60	8.70	9.10	9.50	148.4
	Back	3.10	3.60	3.70	3.90	60.4
	Seat	2.80	3.20	3.40	3.50	53.2
	Arm	1.90	2.20	2.30	2.40	38
K82LH22LAW	Entire Unit	6.70	7.70	8.00	8.40	130.9
	Back	3.10	3.60	3.70	3.90	60.4
	Seat	2.80	3.20	3.40	3.50	53.2
	Arm	1.00	1.20	1.20	1.30	20
K82LH22LAW2RAW	Entire Unit	7.50	8.60	9.00	9.40	145.9
	Back	3.10	3.60	3.70	3.90	60.4
	Seat	2.80	3.20	3.40	3.50	53.2
	Arm	1.80	2.10	2.20	2.30	34
K82LH22LAW2RTW	Entire Unit	7.50	8.60	9.00	9.40	145.9
	Back	3.10	3.60	3.70	3.90	60.4
	Seat	2.80	3.20	3.40	3.50	53.2
	Arm	1.80	2.10	2.20	2.30	34

COM YARDAGE REQUIREMENTS

COM YARDAGE REQUIREMENTS (54" WIDTH – CUT UP THE ROLL)

MODEL	RAILROADED Contact customer service 800-634-9510 for ydg requirements	NON DIRECTIONAL OR SOLID	1"-4" REPEAT	5"-11" REPEAT	12"-18" REPEAT	COL SQUARE FEET
			4" VERTICAL X 4" HORIZONTAL	11" VERTICAL X 11" HORIZONTAL	18" VERTICAL X 18" HORIZONTAL	
K82LH22LAWTRAW	Entire Unit	7.50	8.60	9.00	9.40	145.9
	Back	3.10	3.60	3.70	3.90	60.4
	Seat	2.80	3.20	3.40	3.50	53.2
	Arm	1.90	2.20	2.30	2.40	38
K82LH22LTL	Entire Unit	6.70	7.70	8.00	8.40	130.9
	Back	3.10	3.60	3.70	3.90	60.4
	Seat	2.80	3.20	3.40	3.50	53.2
	Arm	1.00	1.20	1.20	1.30	20
K82LH22LTL2RAU	Entire Unit	6.70	7.70	8.00	8.40	130.9
	Back	3.10	3.60	3.70	3.90	60.4
	Seat	2.80	3.20	3.40	3.50	53.2
	Arm	1.00	1.20	1.20	1.30	20
K82LH22LTT	Entire Unit	6.70	7.70	8.00	8.40	130.9
	Back	3.10	3.60	3.70	3.90	60.4
	Seat	2.80	3.20	3.40	3.50	53.2
	Arm	1.00	1.20	1.20	1.30	20
K82LH22LTT2RAT	Entire Unit	7.50	8.60	9.00	9.40	145.9
	Back	3.10	3.60	3.70	3.90	60.4
	Seat	2.80	3.20	3.40	3.50	53.2
	Arm	1.80	2.10	2.20	2.30	34
K82LH22LTT2RAU	Entire Unit	7.60	8.70	9.10	9.50	148.4
	Back	3.10	3.60	3.70	3.90	60.4
	Seat	2.80	3.20	3.40	3.50	53.2
	Arm	1.90	2.20	2.30	2.40	36
K82LH22LTW	Entire Unit	6.70	7.70	8.00	8.40	130.9
	Back	3.10	3.60	3.70	3.90	60.4
	Seat	2.80	3.20	3.40	3.50	53.2
	Arm	1.00	1.20	1.20	1.30	20
K82LH22LTW2RAU	Entire Unit	7.60	8.70	9.10	9.50	148.4
	Back	3.10	3.60	3.70	3.90	60.4
	Seat	2.80	3.20	3.40	3.50	53.2
	Arm	1.90	2.20	2.30	2.40	36
K82LH22LTW2RAW	Entire Unit	7.50	8.60	9.00	9.40	145.9
	Back	3.10	3.60	3.70	3.90	60.4
	Seat	2.80	3.20	3.40	3.50	53.2
	Arm	1.80	2.10	2.20	2.30	34
K82LH22RAP	Entire Unit	6.70	7.70	8.00	8.40	130.9
	Back	3.10	3.60	3.70	3.90	60.4
	Seat	2.80	3.20	3.40	3.50	53.2
	Arm	1.00	1.20	1.20	1.30	20
K82LH22RAS	Entire Unit	6.70	7.70	8.00	8.40	130.9
	Back	3.10	3.60	3.70	3.90	60.4
	Seat	2.80	3.20	3.40	3.50	53.2
	Arm	1.00	1.20	1.20	1.30	20
K82LH22RAT	Entire Unit	6.70	7.70	8.00	8.40	130.9
	Back	3.10	3.60	3.70	3.90	60.4
	Seat	2.80	3.20	3.40	3.50	53.2
	Arm	1.00	1.20	1.20	1.30	20
K82LH22RAU	Entire Unit	6.70	7.70	8.00	8.40	130.9
	Back	3.10	3.60	3.70	3.90	60.4
	Seat	2.80	3.20	3.40	3.50	53.2
	Arm	1.00	1.20	1.20	1.30	20
K82LH22RAW	Entire Unit	6.70	7.70	8.00	8.40	130.9
	Back	3.10	3.60	3.70	3.90	60.4
	Seat	2.80	3.20	3.40	3.50	53.2
	Arm	1.00	1.20	1.20	1.30	20
K82LH22RTL	Entire Unit	6.70	7.70	8.00	8.40	130.9
	Back	3.10	3.60	3.70	3.90	60.4
	Seat	2.80	3.20	3.40	3.50	53.2
	Arm	1.00	1.20	1.20	1.30	20

COM YARDAGE REQUIREMENTS

COM YARDAGE REQUIREMENTS (54" WIDTH – CUT UP THE ROLL)

MODEL	RAILROADED Contact customer service 800-634-9510 for ydg requirements	NON DIRECTIONAL OR SOLID	1"-4" REPEAT	5"-11" REPEAT	12"-18" REPEAT	COL SQUARE FEET
			4" VERTICAL X 4" HORIZONTAL	11" VERTICAL X 11" HORIZONTAL	18" VERTICAL X 18" HORIZONTAL	
K82LH22RTT	Entire Unit	6.70	7.70	8.00	8.40	130.9
	Back	3.10	3.60	3.70	3.90	60.4
	Seat	2.80	3.20	3.40	3.50	53.2
	Arm	1.00	1.20	1.20	1.30	20
K82LH22RTW	Entire Unit	6.70	7.70	8.00	8.40	130.9
	Back	3.10	3.60	3.70	3.90	60.4
	Seat	2.80	3.20	3.40	3.50	53.2
	Arm	1.00	1.20	1.20	1.30	20
K82LH28LAS	Entire Unit	6.70	7.70	8.00	8.40	130.9
	Back	3.10	3.60	3.70	3.90	60.4
	Seat	2.80	3.20	3.40	3.50	53.2
	Arm	1.00	1.20	1.20	1.30	20
K82LH28LAS8RAS	Entire Unit	7.50	8.60	9.00	9.40	145.9
	Back	3.10	3.60	3.70	3.90	60.4
	Seat	2.80	3.20	3.40	3.50	53.2
	Arm	1.80	2.10	2.20	2.30	36
K82LH28LASTRAS	Entire Unit	7.50	8.60	9.00	9.40	145.9
	Back	3.10	3.60	3.70	3.90	60.4
	Seat	2.80	3.20	3.40	3.50	53.2
	Arm	1.80	2.10	2.20	2.30	36
K82LH28LAT	Entire Unit	6.70	7.70	8.00	8.40	130.9
	Back	3.10	3.60	3.70	3.90	60.4
	Seat	2.80	3.20	3.40	3.50	53.2
	Arm	1.00	1.20	1.20	1.30	20
K82LH28LAT8RAT	Entire Unit	7.50	8.60	9.00	9.40	145.9
	Back	3.10	3.60	3.70	3.90	60.4
	Seat	2.80	3.20	3.40	3.50	53.2
	Arm	1.80	2.10	2.20	2.30	36
K82LH28LAT8RTT	Entire Unit	7.60	8.70	9.10	9.50	148.4
	Back	3.10	3.60	3.70	3.90	60.4
	Seat	2.80	3.20	3.40	3.50	53.2
	Arm	1.80	2.10	2.20	2.30	36
K82LH28LAT8RAT	Entire Unit	7.50	8.60	9.00	9.40	145.9
	Back	3.10	3.60	3.70	3.90	60.4
	Seat	2.80	3.20	3.40	3.50	53.2
	Arm	1.80	2.10	2.20	2.30	36
K82LH28LAU	Entire Unit	6.70	7.70	8.00	8.40	130.9
	Back	3.10	3.60	3.70	3.90	60.4
	Seat	2.80	3.20	3.40	3.50	53.2
	Arm	1.00	1.20	1.20	1.30	20
K82LH28LAU8RAU	Entire Unit	7.60	8.70	9.10	9.50	148.4
	Back	3.10	3.60	3.70	3.90	60.4
	Seat	2.80	3.20	3.40	3.50	53.2
	Arm	1.90	2.20	2.30	2.40	36
K82LH28LAU8RTL	Entire Unit	7.60	8.70	9.10	9.50	148.4
	Back	3.10	3.60	3.70	3.90	60.4
	Seat	2.80	3.20	3.40	3.50	53.2
	Arm	1.90	2.20	2.30	2.40	36
K82LH28LAU8RTT	Entire Unit	7.60	8.70	9.10	9.50	148.4
	Back	3.10	3.60	3.70	3.90	60.4
	Seat	2.80	3.20	3.40	3.50	53.2
	Arm	1.90	2.20	2.30	2.40	36
K82LH28LAU8RTW	Entire Unit	7.60	8.70	9.10	9.50	148.4
	Back	3.10	3.60	3.70	3.90	60.4
	Seat	2.80	3.20	3.40	3.50	53.2
	Arm	1.90	2.20	2.30	2.40	36
K82LH28LAUTRAU	Entire Unit	7.60	8.70	9.10	9.50	148.4
	Back	3.10	3.60	3.70	3.90	60.4
	Seat	2.80	3.20	3.40	3.50	53.2
	Arm	1.90	2.20	2.30	2.40	36

COM YARDAGE REQUIREMENTS

COM YARDAGE REQUIREMENTS (54" WIDTH – CUT UP THE ROLL)

MODEL	RAILROADED Contact customer service 800-634-9510 for ydg requirements	NON DIRECTIONAL OR SOLID	1"-4" REPEAT	5"-11" REPEAT	12"-18" REPEAT	COL SQUARE FEET
			4" VERTICAL X 4" HORIZONTAL	11" VERTICAL X 11" HORIZONTAL	18" VERTICAL X 18" HORIZONTAL	
K82LH28LAW	Entire Unit	6.70	7.70	8.00	8.40	130.9
	Back	3.10	3.60	3.70	3.90	60.4
	Seat	2.80	3.20	3.40	3.50	53.2
	Arm	1.00	1.20	1.20	1.30	20
K82LH28LAW8RAW	Entire Unit	7.50	8.60	9.00	9.40	145.9
	Back	3.10	3.60	3.70	3.90	60.4
	Seat	2.80	3.20	3.40	3.50	53.2
	Arm	1.80	2.10	2.20	2.30	36
K82LH28LAW8RTW	Entire Unit	7.60	8.70	9.10	9.50	148.4
	Back	3.10	3.60	3.70	3.90	60.4
	Seat	2.80	3.20	3.40	3.50	53.2
	Arm	1.80	2.10	2.20	2.30	36
K82LH28LAWTRAW	Entire Unit	7.50	8.60	9.00	9.40	145.9
	Back	3.10	3.60	3.70	3.90	60.4
	Seat	2.80	3.20	3.40	3.50	53.2
	Arm	1.80	2.10	2.20	2.30	36
K82LH28LTL	Entire Unit	6.70	7.70	8.00	8.40	130.9
	Back	3.10	3.60	3.70	3.90	60.4
	Seat	2.80	3.20	3.40	3.50	53.2
	Arm	1.00	1.20	1.20	1.30	20
K82LH28LTL8RAU	Entire Unit	7.60	8.70	9.10	9.50	148.4
	Back	3.10	3.60	3.70	3.90	60.4
	Seat	2.80	3.20	3.40	3.50	53.2
	Arm	1.90	2.20	2.30	2.40	36
K82LH28LTL8RTL	Entire Unit	7.60	8.70	9.10	9.50	148.4
	Back	3.10	3.60	3.70	3.90	60.4
	Seat	2.80	3.20	3.40	3.50	53.2
	Arm	1.90	2.20	2.30	2.40	36
K82LH28LTT	Entire Unit	6.70	7.70	8.00	8.40	130.9
	Back	3.10	3.60	3.70	3.90	60.4
	Seat	2.80	3.20	3.40	3.50	53.2
	Arm	1.00	1.20	1.20	1.30	20
K82LH28LTT8RAT	Entire Unit	7.60	8.70	9.10	9.50	148.4
	Back	3.10	3.60	3.70	3.90	60.4
	Seat	2.80	3.20	3.40	3.50	53.2
	Arm	1.80	2.10	2.20	2.30	36
K82LH28LTT8RAU	Entire Unit	7.60	8.70	9.10	9.50	148.4
	Back	3.10	3.60	3.70	3.90	60.4
	Seat	2.80	3.20	3.40	3.50	53.2
	Arm	1.90	2.20	2.30	2.40	36
K82LH28LTT8RTT	Entire Unit	7.60	8.70	9.10	9.50	148.4
	Back	3.10	3.60	3.70	3.90	60.4
	Seat	2.80	3.20	3.40	3.50	53.2
	Arm	1.90	2.20	2.30	2.40	36
K82LH28LTTW	Entire Unit	6.70	7.70	8.00	8.40	130.9
	Back	3.10	3.60	3.70	3.90	60.4
	Seat	2.80	3.20	3.40	3.50	53.2
	Arm	1.00	1.20	1.20	1.30	20
K82LH28LTTW8RAU	Entire Unit	7.60	8.70	9.10	9.50	148.4
	Back	3.10	3.60	3.70	3.90	60.4
	Seat	2.80	3.20	3.40	3.50	53.2
	Arm	1.90	2.20	2.30	2.40	36
K82LH28LTTW8RAW	Entire Unit	7.60	8.70	9.10	9.50	148.4
	Back	3.10	3.60	3.70	3.90	60.4
	Seat	2.80	3.20	3.40	3.50	53.2
	Arm	1.80	2.10	2.20	2.30	36
K82LH28LTTW8RTW	Entire Unit	7.60	8.70	9.10	9.50	148.4
	Back	3.10	3.60	3.70	3.90	60.4
	Seat	2.80	3.20	3.40	3.50	53.2
	Arm	1.90	2.20	2.30	2.40	36

COM YARDAGE REQUIREMENTS

COM YARDAGE REQUIREMENTS (54" WIDTH – CUT UP THE ROLL)

MODEL	RAILROADED Contact customer service 800-634-9510 for ydg requirements	NON DIRECTIONAL OR SOLID	1"-4" REPEAT	5"-11" REPEAT	12"-18" REPEAT	COL SQUARE FEET
			4" VERTICAL X 4" HORIZONTAL	11" VERTICAL X 11" HORIZONTAL	18" VERTICAL X 18" HORIZONTAL	
K82LH28RAS	Entire Unit	6.70	7.70	8.00	8.40	130.9
	Back	3.10	3.60	3.70	3.90	60.4
	Seat	2.80	3.20	3.40	3.50	53.2
	Arm	1.00	1.20	1.20	1.30	20
K82LH28RAT	Entire Unit	6.70	7.70	8.00	8.40	130.9
	Back	3.10	3.60	3.70	3.90	60.4
	Seat	2.80	3.20	3.40	3.50	53.2
	Arm	1.00	1.20	1.20	1.30	20
K82LH28RAU	Entire Unit	6.70	7.70	8.00	8.40	130.9
	Back	3.10	3.60	3.70	3.90	60.4
	Seat	2.80	3.20	3.40	3.50	53.2
	Arm	1.00	1.20	1.20	1.30	20
K82LH28RAW	Entire Unit	6.70	7.70	8.00	8.40	130.9
	Back	3.10	3.60	3.70	3.90	60.4
	Seat	2.80	3.20	3.40	3.50	53.2
	Arm	1.00	1.20	1.20	1.30	20
K82LH28RTL	Entire Unit	6.70	7.70	8.00	8.40	130.9
	Back	3.10	3.60	3.70	3.90	60.4
	Seat	2.80	3.20	3.40	3.50	53.2
	Arm	1.00	1.20	1.20	1.30	20
K82LH28RTT	Entire Unit	6.70	7.70	8.00	8.40	130.9
	Back	3.10	3.60	3.70	3.90	60.4
	Seat	2.80	3.20	3.40	3.50	53.2
	Arm	1.00	1.20	1.20	1.30	20
K82LH28RTW	Entire Unit	6.70	7.70	8.00	8.40	130.9
	Back	3.10	3.60	3.70	3.90	60.4
	Seat	2.80	3.20	3.40	3.50	53.2
	Arm	1.00	1.20	1.20	1.30	20
K82LH2TLAS	Entire Unit	6.70	7.70	8.00	8.40	130.9
	Back	3.10	3.60	3.70	3.90	60.4
	Seat	2.80	3.20	3.40	3.50	53.2
	Arm	1.00	1.20	1.20	1.30	20
K82LH2TLAS2RAS	Entire Unit	7.50	8.60	9.00	9.40	145.9
	Back	3.10	3.60	3.70	3.90	60.4
	Seat	2.80	3.20	3.40	3.50	53.2
	Arm	1.90	2.20	2.30	2.40	38
K82LH2TLAS8RAS	Entire Unit	7.50	8.60	9.00	9.40	145.9
	Back	3.10	3.60	3.70	3.90	60.4
	Seat	2.80	3.20	3.40	3.50	53.2
	Arm	1.80	2.10	2.20	2.30	36
K82LH2TLASTRAS	Entire Unit	7.60	8.70	9.10	9.50	148.4
	Back	3.10	3.60	3.70	3.90	60.4
	Seat	2.80	3.20	3.40	3.50	53.2
	Arm	1.90	2.20	2.30	2.40	36
K82LH2TLAT	Entire Unit	6.70	7.70	8.00	8.40	130.9
	Back	3.10	3.60	3.70	3.90	60.4
	Seat	2.80	3.20	3.40	3.50	53.2
	Arm	1.00	1.20	1.20	1.30	20
K82LH2TLAT2RAT	Entire Unit	7.50	8.60	9.00	9.40	145.9
	Back	3.10	3.60	3.70	3.90	60.4
	Seat	2.80	3.20	3.40	3.50	53.2
	Arm	1.90	2.20	2.30	2.40	38
K82LH2TLAT8RAT	Entire Unit	7.50	8.60	9.00	9.40	145.9
	Back	3.10	3.60	3.70	3.90	60.4
	Seat	2.80	3.20	3.40	3.50	53.2
	Arm	1.90	2.20	2.30	2.40	38
K82LH2TLATTRAT	Entire Unit	7.60	8.70	9.10	9.50	148.4
	Back	3.10	3.60	3.70	3.90	60.4
	Seat	2.80	3.20	3.40	3.50	53.2
	Arm	1.90	2.20	2.30	2.40	36

COM YARDAGE REQUIREMENTS

COM YARDAGE REQUIREMENTS (54" WIDTH – CUT UP THE ROLL)

MODEL	RAILROADED Contact customer service 800-634-9510 for ydg requirements	NON DIRECTIONAL OR SOLID	1"-4" REPEAT	5"-11" REPEAT	12"-18" REPEAT	COL SQUARE FEET
			4" VERTICAL X 4" HORIZONTAL	11" VERTICAL X 11" HORIZONTAL	18" VERTICAL X 18" HORIZONTAL	
K82LH2TLAU	Entire Unit	6.70	7.70	8.00	8.40	130.9
	Back	3.10	3.60	3.70	3.90	60.4
	Seat	2.80	3.20	3.40	3.50	53.2
	Arm	1.00	1.20	1.20	1.30	20
K82LH2TLAU2RAU	Entire Unit	7.60	8.70	9.10	9.50	148.4
	Back	3.10	3.60	3.70	3.90	60.4
	Seat	2.80	3.20	3.40	3.50	53.2
	Arm	1.90	2.20	2.30	2.40	38
K82LH2TLAU8RAU	Entire Unit	7.60	8.70	9.10	9.50	148.4
	Back	3.10	3.60	3.70	3.90	60.4
	Seat	2.80	3.20	3.40	3.50	53.2
	Arm	1.90	2.20	2.30	2.40	36
K82LH2TLAU8TRAU	Entire Unit	7.60	8.70	9.10	9.50	148.4
	Back	3.10	3.60	3.70	3.90	60.4
	Seat	2.80	3.20	3.40	3.50	53.2
	Arm	1.90	2.20	2.30	2.40	36
K82LH2TLAW	Entire Unit	6.70	7.70	8.00	8.40	130.9
	Back	3.10	3.60	3.70	3.90	60.4
	Seat	2.80	3.20	3.40	3.50	53.2
	Arm	1.00	1.20	1.20	1.30	20
K82LH2TLAW2RAW	Entire Unit	7.50	8.60	9.00	9.40	145.9
	Back	3.10	3.60	3.70	3.90	60.4
	Seat	2.80	3.20	3.40	3.50	53.2
	Arm	1.90	2.20	2.30	2.40	38
K82LH2TLAW8RAW	Entire Unit	7.50	8.60	9.00	9.40	145.9
	Back	3.10	3.60	3.70	3.90	60.4
	Seat	2.80	3.20	3.40	3.50	53.2
	Arm	1.80	2.10	2.20	2.30	36
K82LH2TLAW8TRAU	Entire Unit	7.60	8.70	9.10	9.50	148.4
	Back	3.10	3.60	3.70	3.90	60.4
	Seat	2.80	3.20	3.40	3.50	53.2
	Arm	1.90	2.20	2.30	2.40	36
K82LH2TRAS	Entire Unit	6.70	7.70	8.00	8.40	130.9
	Back	3.10	3.60	3.70	3.90	60.4
	Seat	2.80	3.20	3.40	3.50	53.2
	Arm	1.00	1.20	1.20	1.30	20
K82LH2TRAT	Entire Unit	6.70	7.70	8.00	8.40	130.9
	Back	3.10	3.60	3.70	3.90	60.4
	Seat	2.80	3.20	3.40	3.50	53.2
	Arm	1.00	1.20	1.20	1.30	20
K82LH2TRAU	Entire Unit	6.70	7.70	8.00	8.40	130.9
	Back	3.10	3.60	3.70	3.90	60.4
	Seat	2.80	3.20	3.40	3.50	53.2
	Arm	1.00	1.20	1.20	1.30	20
K82LH2TRAW	Entire Unit	6.70	7.70	8.00	8.40	130.9
	Back	3.10	3.60	3.70	3.90	60.4
	Seat	2.80	3.20	3.40	3.50	53.2
	Arm	1.00	1.20	1.20	1.30	20
K82LH3	Entire Unit	8.70	10.00	10.40	10.90	168.3
	Back	4.50	5.20	5.40	5.60	89.7
	Seat	4.20	4.80	5.00	5.30	79.2
K82LH32LAP	Entire Unit	9.60	11.00	11.50	12.00	186.8
	Back	4.50	5.20	5.40	5.60	89.7
	Seat	4.20	4.80	5.00	5.30	79.2
	Arm	1.00	1.20	1.20	1.30	20
K82LH32LAP2RAP	Entire Unit	10.50	12.10	12.60	13.10	204.3
	Back	4.50	5.20	5.40	5.60	89.7
	Seat	4.20	4.80	5.00	5.30	79.2
	Arm	1.80	2.10	2.20	2.30	34

COM YARDAGE REQUIREMENTS

COM YARDAGE REQUIREMENTS (54" WIDTH – CUT UP THE ROLL)

MODEL	RAILROADED Contact customer service 800-634-9510 for ydg requirements	NON DIRECTIONAL OR SOLID	1"-4" REPEAT	5"-11" REPEAT	12"-18" REPEAT	COL SQUARE FEET
			4" VERTICAL X 4" HORIZONTAL	11" VERTICAL X 11" HORIZONTAL	18" VERTICAL X 18" HORIZONTAL	
K82LH32LAS	Entire Unit	9.60	11.00	11.50	12.00	186.8
	Back	4.50	5.20	5.40	5.60	89.7
	Seat	4.20	4.80	5.00	5.30	79.2
	Arm	1.00	1.20	1.20	1.30	20
K82LH32LAS2RAS	Entire Unit	10.50	12.10	12.60	13.10	204.3
	Back	4.50	5.20	5.40	5.60	89.7
	Seat	4.20	4.80	5.00	5.30	79.2
	Arm	1.80	2.10	2.20	2.30	34
K82LH32LASTRAS	Entire Unit	10.40	12.00	12.50	13.00	202.3
	Back	4.50	5.20	5.40	5.60	89.7
	Seat	4.20	4.80	5.00	5.30	79.2
	Arm	1.90	2.20	2.30	2.40	38
K82LH32LAT	Entire Unit	9.60	11.00	11.50	12.00	186.8
	Back	4.50	5.20	5.40	5.60	89.7
	Seat	4.20	4.80	5.00	5.30	79.2
	Arm	1.00	1.20	1.20	1.30	20
K82LH32LAT2RAT	Entire Unit	10.50	12.10	12.60	13.10	204.3
	Back	4.50	5.20	5.40	5.60	89.7
	Seat	4.20	4.80	5.00	5.30	79.2
	Arm	1.80	2.10	2.20	2.30	34
K82LH32LAT2RTT	Entire Unit	10.40	12.00	12.50	13.00	202.3
	Back	4.50	5.20	5.40	5.60	89.7
	Seat	4.20	4.80	5.00	5.30	79.2
	Arm	1.80	2.10	2.20	2.30	34
K82LH32LATTRAT	Entire Unit	10.40	12.00	12.50	13.00	202.3
	Back	4.50	5.20	5.40	5.60	89.7
	Seat	4.20	4.80	5.00	5.30	79.2
	Arm	1.90	2.20	2.30	2.40	38
K82LH32LAU	Entire Unit	9.60	11.00	11.50	12.00	186.8
	Back	4.50	5.20	5.40	5.60	89.7
	Seat	4.20	4.80	5.00	5.30	79.2
	Arm	1.00	1.20	1.20	1.30	20
K82LH32LAU2RAU	Entire Unit	10.50	12.10	12.60	13.10	204.3
	Back	4.50	5.20	5.40	5.60	89.7
	Seat	4.00	4.60	4.80	5.00	79.2
	Arm	1.90	2.20	2.30	2.40	36
K82LH32LAU2RTL	Entire Unit	10.30	11.80	12.40	12.90	204.3
	Back	4.50	5.20	5.40	5.60	89.7
	Seat	4.00	4.60	4.80	5.00	79.2
	Arm	1.90	2.20	2.30	2.40	36
K82LH32LAU2RTT	Entire Unit	10.30	11.80	12.40	12.90	204.3
	Back	4.50	5.20	5.40	5.60	89.7
	Seat	4.00	4.60	4.80	5.00	79.2
	Arm	1.90	2.20	2.30	2.40	36
K82LH32LAU2RTW	Entire Unit	10.50	12.10	12.60	13.10	204.3
	Back	4.50	5.20	5.40	5.60	89.7
	Seat	4.20	4.80	5.00	5.30	79.2
	Arm	1.90	2.20	2.30	2.40	36
K82LH32LAUTRAU	Entire Unit	10.50	12.10	12.60	13.10	204.3
	Back	4.50	5.20	5.40	5.60	89.7
	Seat	4.20	4.80	5.00	5.30	79.2
	Arm	1.90	2.20	2.30	2.40	38
K82LH32LAW	Entire Unit	5.20	6.00	6.20	6.50	98.8
	Back	4.50	5.20	5.40	5.60	89.7
	Seat	4.20	4.80	5.00	5.30	79.2
	Arm	1.80	2.10	2.20	2.30	34
K82LH32LAW2RAW	Entire Unit	10.50	12.10	12.60	13.10	204.3
	Back	4.50	5.20	5.40	5.60	89.7
	Seat	4.20	4.80	5.00	5.30	79.2
	Arm	1.80	2.10	2.20	2.30	34

COM YARDAGE REQUIREMENTS

COM YARDAGE REQUIREMENTS (54" WIDTH – CUT UP THE ROLL)

MODEL	RAILROADED Contact customer service 800-634-9510 for ydg requirements	NON DIRECTIONAL OR SOLID	1"-4" REPEAT	5"-11" REPEAT	12"-18" REPEAT	COL SQUARE FEET
			4" VERTICAL X 4" HORIZONTAL	11" VERTICAL X 11" HORIZONTAL	18" VERTICAL X 18" HORIZONTAL	
K82LH32LAW2RTW	Entire Unit	10.40	12.00	12.50	13.00	202.3
	Back	4.50	5.20	5.40	5.60	89.7
	Seat	4.20	4.80	5.00	5.30	79.2
	Arm	1.80	2.10	2.20	2.30	34
K82LH32LAWTRAW	Entire Unit	10.40	12.00	12.50	13.00	202.3
	Back	4.50	5.20	5.40	5.60	89.7
	Seat	4.20	4.80	5.00	5.30	79.2
	Arm	1.90	2.20	2.30	2.40	38
K82LH32LTL	Entire Unit	9.60	11.00	11.50	12.00	186.8
	Back	4.50	5.20	5.40	5.60	89.7
	Seat	4.20	4.80	5.00	5.30	79.2
	Arm	1.00	1.20	1.20	1.30	20
K82LH32LTL2RAU	Entire Unit	10.50	12.10	12.60	13.10	204.3
	Back	4.50	5.20	5.40	5.60	89.7
	Seat	4.20	4.80	5.00	5.30	79.2
	Arm	1.90	2.20	2.30	2.40	36
K82LH32LTT	Entire Unit	9.60	11.00	11.50	12.00	186.8
	Back	4.50	5.20	5.40	5.60	89.7
	Seat	4.20	4.80	5.00	5.30	79.2
	Arm	1.00	1.20	1.20	1.30	20
K82LH32LTT2RAT	Entire Unit	10.40	12.00	12.50	13.00	202.3
	Back	4.50	5.20	5.40	5.60	89.7
	Seat	4.20	4.80	5.00	5.30	79.2
	Arm	1.80	2.10	2.20	2.30	34
K82LH32LTT2RAU	Entire Unit	10.50	12.10	12.60	13.10	204.3
	Back	4.50	5.20	5.40	5.60	89.7
	Seat	4.20	4.80	5.00	5.30	79.2
	Arm	1.90	2.20	2.30	2.40	36
K82LH32LTTW	Entire Unit	9.60	11.00	11.50	12.00	186.8
	Back	4.50	5.20	5.40	5.60	89.7
	Seat	4.20	4.80	5.00	5.30	79.2
	Arm	1.00	1.20	1.20	1.30	20
K82LH32LTTW2RAU	Entire Unit	10.50	12.10	12.60	13.10	204.3
	Back	4.50	5.20	5.40	5.60	89.7
	Seat	4.20	4.80	5.00	5.30	79.2
	Arm	1.90	2.20	2.30	2.40	36
K82LH32LTTW2RAW	Entire Unit	10.40	12.00	12.50	13.00	202.3
	Back	4.50	5.20	5.40	5.60	89.7
	Seat	4.20	4.80	5.00	5.30	79.2
	Arm	1.80	2.10	2.20	2.30	34
K82LH32RAP	Entire Unit	9.60	11.00	11.50	12.00	186.8
	Back	4.50	5.20	5.40	5.60	89.7
	Seat	4.20	4.80	5.00	5.30	79.2
	Arm	1.00	1.20	1.20	1.30	20
K82LH32RAS	Entire Unit	9.60	11.00	11.50	12.00	186.8
	Back	4.50	5.20	5.40	5.60	89.7
	Seat	4.20	4.80	5.00	5.30	79.2
	Arm	1.00	1.20	1.20	1.30	20
K82LH32RAT	Entire Unit	9.60	11.00	11.50	12.00	186.8
	Back	4.50	5.20	5.40	5.60	89.7
	Seat	4.20	4.80	5.00	5.30	79.2
	Arm	1.00	1.20	1.20	1.30	20
K82LH32RAU	Entire Unit	9.60	11.00	11.50	12.00	186.8
	Back	4.50	5.20	5.40	5.60	89.7
	Seat	4.20	4.80	5.00	5.30	79.2
	Arm	1.00	1.20	1.20	1.30	20
K82LH32RAW	Entire Unit	9.60	11.00	11.50	12.00	186.8
	Back	4.50	5.20	5.40	5.60	89.7
	Seat	4.20	4.80	5.00	5.30	79.2
	Arm	1.00	1.20	1.20	1.30	20

COM YARDAGE REQUIREMENTS

COM YARDAGE REQUIREMENTS (54" WIDTH – CUT UP THE ROLL)

MODEL	RAILROADED Contact customer service 800-634-9510 for ydg requirements	NON DIRECTIONAL OR SOLID	1"-4" REPEAT	5"-11" REPEAT	12"-18" REPEAT	COL SQUARE FEET
			4" VERTICAL X 4" HORIZONTAL	11" VERTICAL X 11" HORIZONTAL	18" VERTICAL X 18" HORIZONTAL	
K82LH32RTL	Entire Unit	9.60	11.00	11.50	12.00	186.8
	Back	4.50	5.20	5.40	5.60	89.7
	Seat	4.20	4.80	5.00	5.30	79.2
	Arm	1.00	1.20	1.20	1.30	20
K82LH32RTT	Entire Unit	9.60	11.00	11.50	12.00	186.8
	Back	4.50	5.20	5.40	5.60	89.7
	Seat	4.20	4.80	5.00	5.30	79.2
	Arm	1.00	1.20	1.20	1.30	20
K82LH32RTW	Entire Unit	9.60	11.00	11.50	12.00	186.8
	Back	4.50	5.20	5.40	5.60	89.7
	Seat	4.20	4.80	5.00	5.30	79.2
	Arm	1.00	1.20	1.20	1.30	20
K82LH38LAS	Entire Unit	9.60	11.00	11.50	12.00	186.8
	Back	4.50	5.20	5.40	5.60	89.7
	Seat	4.20	4.80	5.00	5.30	79.2
	Arm	1.00	1.20	1.20	1.30	20
K82LH38LAS8RAS	Entire Unit	10.40	12.00	12.50	13.00	202.3
	Back	4.50	5.20	5.40	5.60	89.7
	Seat	4.20	4.80	5.00	5.30	79.2
	Arm	1.80	2.10	2.20	2.30	36
K82LH38LASTRAS	Entire Unit	10.40	12.00	12.50	13.00	202.3
	Back	4.50	5.20	5.40	5.60	89.7
	Seat	4.20	4.80	5.00	5.30	79.2
	Arm	1.80	2.10	2.20	2.30	36
K82LH38LAT	Entire Unit	9.60	11.00	11.50	12.00	186.8
	Back	4.50	5.20	5.40	5.60	89.7
	Seat	4.20	4.80	5.00	5.30	79.2
	Arm	1.00	1.20	1.20	1.30	20
K82LH38LAT8RAT	Entire Unit	10.40	12.00	12.50	13.00	202.3
	Back	4.50	5.20	5.40	5.60	89.7
	Seat	4.20	4.80	5.00	5.30	79.2
	Arm	1.80	2.10	2.20	2.30	36
K82LH38LAT8RTT	Entire Unit	10.40	12.00	12.50	13.00	202.3
	Back	4.50	5.20	5.40	5.60	89.7
	Seat	4.20	4.80	5.00	5.30	79.2
	Arm	1.80	2.10	2.20	2.30	36
K82LH38LATTRAT	Entire Unit	10.40	12.00	12.50	13.00	202.3
	Back	4.50	5.20	5.40	5.60	89.7
	Seat	4.20	4.80	5.00	5.30	79.2
	Arm	1.80	2.10	2.20	2.30	36
K82LH38LAU	Entire Unit	9.60	11.00	11.50	12.00	186.8
	Back	4.50	5.20	5.40	5.60	89.7
	Seat	4.20	4.80	5.00	5.30	79.2
	Arm	1.00	1.20	1.20	1.30	20
K82LH38LAU8RAU	Entire Unit	10.50	12.10	12.60	13.10	204.3
	Back	4.50	5.20	5.40	5.60	89.7
	Seat	4.20	4.80	5.00	5.30	79.2
	Arm	1.90	2.20	2.30	2.40	36
K82LH38LAU8RTL	Entire Unit	10.50	12.10	12.60	13.10	204.3
	Back	4.50	5.20	5.40	5.60	89.7
	Seat	4.20	4.80	5.00	5.30	79.2
	Arm	1.90	2.20	2.30	2.40	36
K82LH38LAU8RTT	Entire Unit	10.50	12.10	12.60	13.10	204.3
	Back	4.50	5.20	5.40	5.60	89.7
	Seat	4.20	4.80	5.00	5.30	79.2
	Arm	1.90	2.20	2.30	2.40	36
K82LH38LAU8RTW	Entire Unit	10.50	12.10	12.60	13.10	204.3
	Back	4.50	5.20	5.40	5.60	89.7
	Seat	4.20	4.80	5.00	5.30	79.2
	Arm	1.90	2.20	2.30	2.40	36

COM YARDAGE REQUIREMENTS

COM YARDAGE REQUIREMENTS (54" WIDTH – CUT UP THE ROLL)

MODEL	RAILROADED Contact customer service 800-634-9510 for ydg requirements	NON DIRECTIONAL OR SOLID	1"-4" REPEAT	5"-11" REPEAT	12"-18" REPEAT	COL SQUARE FEET
			4" VERTICAL X 4" HORIZONTAL	11" VERTICAL X 11" HORIZONTAL	18" VERTICAL X 18" HORIZONTAL	
K82LH38LAUTRAU	Entire Unit	10.50	12.10	12.60	13.10	204.3
	Back	4.50	5.20	5.40	5.60	89.7
	Seat	4.20	4.80	5.00	5.30	79.2
	Arm	1.90	2.20	2.30	2.40	36
K82LH38LAW	Entire Unit	9.60	11.00	11.50	12.00	186.8
	Back	4.50	5.20	5.40	5.60	89.7
	Seat	4.20	4.80	5.00	5.30	79.2
	Arm	1.00	1.20	1.20	1.30	20
K82LH38LAW8RAW	Entire Unit	10.40	12.00	12.50	13.00	202.3
	Back	4.50	5.20	5.40	5.60	89.7
	Seat	4.20	4.80	5.00	5.30	79.2
	Arm	1.80	2.10	2.20	2.30	36
K82LH38LAW8RTW	Entire Unit	10.40	12.00	12.50	13.00	202.3
	Back	4.50	5.20	5.40	5.60	89.7
	Seat	4.20	4.80	5.00	5.30	79.2
	Arm	1.80	2.10	2.20	2.30	36
K82LH38LAWTRAW	Entire Unit	10.40	12.00	12.50	13.00	202.3
	Back	4.50	5.20	5.40	5.60	89.7
	Seat	4.20	4.80	5.00	5.30	79.2
	Arm	1.80	2.10	2.20	2.30	36
K82LH38LTL	Entire Unit	9.60	11.00	11.50	12.00	186.8
	Back	4.50	5.20	5.40	5.60	89.7
	Seat	4.20	4.80	5.00	5.30	79.2
	Arm	1.00	1.20	1.20	1.30	20
K82LH38LTL8RAU	Entire Unit	10.50	12.10	12.60	13.10	204.3
	Back	4.50	5.20	5.40	5.60	89.7
	Seat	4.20	4.80	5.00	5.30	79.2
	Arm	1.90	2.20	2.30	2.40	36
K82LH38LTL8RTL	Entire Unit	10.50	12.10	12.60	13.10	204.3
	Back	4.50	5.20	5.40	5.60	89.7
	Seat	4.20	4.80	5.00	5.30	79.2
	Arm	1.90	2.20	2.30	2.40	36
K82LH38LTT	Entire Unit	9.60	11.00	11.50	12.00	186.8
	Back	4.50	5.20	5.40	5.60	89.7
	Seat	4.20	4.80	5.00	5.30	79.2
	Arm	1.00	1.20	1.20	1.30	20
K82LH38LTT8RAT	Entire Unit	10.40	12.00	12.50	13.00	202.3
	Back	4.50	5.20	5.40	5.60	89.7
	Seat	4.20	4.80	5.00	5.30	79.2
	Arm	1.80	2.10	2.20	2.30	36
K82LH38LTT8RAU	Entire Unit	10.50	12.10	12.60	13.10	204.3
	Back	4.50	5.20	5.40	5.60	89.7
	Seat	4.20	4.80	5.00	5.30	79.2
	Arm	1.90	2.20	2.30	2.40	36
K82LH38LTT8RTT	Entire Unit	10.50	12.10	12.60	13.10	204.3
	Back	4.50	5.20	5.40	5.60	89.7
	Seat	4.20	4.80	5.00	5.30	79.2
	Arm	1.90	2.20	2.30	2.40	36
K82LH38LTTW	Entire Unit	9.60	11.00	11.50	12.00	186.8
	Back	4.50	5.20	5.40	5.60	89.7
	Seat	4.20	4.80	5.00	5.30	79.2
	Arm	1.00	1.20	1.20	1.30	20
K82LH38LTTW8RAU	Entire Unit	10.50	12.10	12.60	13.10	204.3
	Back	4.50	5.20	5.40	5.60	89.7
	Seat	4.20	4.80	5.00	5.30	79.2
	Arm	1.90	2.20	2.30	2.40	36
K82LH38LTTW8RAW	Entire Unit	10.40	12.00	12.50	13.00	202.3
	Back	4.50	5.20	5.40	5.60	89.7
	Seat	4.20	4.80	5.00	5.30	79.2
	Arm	1.80	2.10	2.20	2.30	36

COM YARDAGE REQUIREMENTS

COM YARDAGE REQUIREMENTS (54" WIDTH – CUT UP THE ROLL)

MODEL	RAILROADED Contact customer service 800-634-9510 for ydg requirements	NON DIRECTIONAL OR SOLID	1"-4" REPEAT	5"-11" REPEAT	12"-18" REPEAT	COL SQUARE FEET
			4" VERTICAL X 4" HORIZONTAL	11" VERTICAL X 11" HORIZONTAL	18" VERTICAL X 18" HORIZONTAL	
K82LH38LTW8RTW	Entire Unit	10.50	12.10	12.60	13.10	204.3
	Back	4.50	5.20	5.40	5.60	89.7
	Seat	4.20	4.80	5.00	5.30	79.2
	Arm	1.90	2.20	2.30	2.40	36
K82LH38RAS	Entire Unit	9.60	11.00	11.50	12.00	186.8
	Back	4.50	5.20	5.40	5.60	89.7
	Seat	4.20	4.80	5.00	5.30	79.2
	Arm	1.00	1.20	1.20	1.30	20
K82LH38RAT	Entire Unit	9.60	11.00	11.50	12.00	186.8
	Back	4.50	5.20	5.40	5.60	89.7
	Seat	4.20	4.80	5.00	5.30	79.2
	Arm	1.00	1.20	1.20	1.30	20
K82LH38RAU	Entire Unit	9.60	11.00	11.50	12.00	186.8
	Back	4.50	5.20	5.40	5.60	89.7
	Seat	4.20	4.80	5.00	5.30	79.2
	Arm	1.00	1.20	1.20	1.30	20
K82LH38RAW	Entire Unit	9.60	11.00	11.50	12.00	186.8
	Back	4.50	5.20	5.40	5.60	89.7
	Seat	4.20	4.80	5.00	5.30	79.2
	Arm	1.00	1.20	1.20	1.30	20
K82LH38RTL	Entire Unit	9.60	11.00	11.50	12.00	186.8
	Back	4.50	5.20	5.40	5.60	89.7
	Seat	4.20	4.80	5.00	5.30	79.2
	Arm	1.00	1.20	1.20	1.30	20
K82LH38RTT	Entire Unit	9.60	11.00	11.50	12.00	186.8
	Back	4.50	5.20	5.40	5.60	89.7
	Seat	4.20	4.80	5.00	5.30	79.2
	Arm	1.00	1.20	1.20	1.30	20
K82LH38RTW	Entire Unit	9.60	11.00	11.50	12.00	186.8
	Back	4.50	5.20	5.40	5.60	89.7
	Seat	4.20	4.80	5.00	5.30	79.2
	Arm	1.00	1.20	1.20	1.30	20
K82LH3TLAS	Entire Unit	9.60	11.00	11.50	12.00	186.8
	Back	4.50	5.20	5.40	5.60	89.7
	Seat	4.20	4.80	5.00	5.30	79.2
	Arm	1.00	1.20	1.20	1.30	20
K82LH3TLAS2RAS	Entire Unit	10.40	12.00	12.50	13.00	202.3
	Back	4.50	5.20	5.40	5.60	89.7
	Seat	4.20	4.80	5.00	5.30	79.2
	Arm	1.90	2.20	2.30	2.40	38
K82LH3TLAS8RAS	Entire Unit	10.40	12.00	12.50	13.00	202.3
	Back	4.50	5.20	5.40	5.60	89.7
	Seat	4.20	4.80	5.00	5.30	79.2
	Arm	1.80	2.10	2.20	2.30	36
K82LH3TLAS8RAS	Entire Unit	10.50	12.10	12.60	13.10	204.3
	Back	4.50	5.20	5.40	5.60	89.7
	Seat	4.20	4.80	5.00	5.30	79.2
	Arm	1.90	2.20	2.30	2.40	36
K82LH3TLAT	Entire Unit	9.60	11.00	11.50	12.00	186.8
	Back	4.50	5.20	5.40	5.60	89.7
	Seat	4.20	4.80	5.00	5.30	79.2
	Arm	1.00	1.20	1.20	1.30	20
K82LH3TLAT2RAT	Entire Unit	10.40	12.00	12.50	13.00	202.3
	Back	4.50	5.20	5.40	5.60	89.7
	Seat	4.20	4.80	5.00	5.30	79.2
	Arm	1.90	2.20	2.30	2.40	38
K82LH3TLAT8RAT	Entire Unit	10.40	12.00	12.50	13.00	202.3
	Back	4.50	5.20	5.40	5.60	89.7
	Seat	4.20	4.80	5.00	5.30	79.2
	Arm	1.80	2.10	2.20	2.30	36

COM YARDAGE REQUIREMENTS

COM YARDAGE REQUIREMENTS (54" WIDTH – CUT UP THE ROLL)

MODEL	RAILROADED Contact customer service 800-634-9510 for ydg requirements	NON DIRECTIONAL OR SOLID	1"-4" REPEAT	5"-11" REPEAT	12"-18" REPEAT	COL SQUARE FEET
			4" VERTICAL X 4" HORIZONTAL	11" VERTICAL X 11" HORIZONTAL	18" VERTICAL X 18" HORIZONTAL	
K82LH3TLATTRAT	Entire Unit	10.50	12.10	12.60	13.10	204.3
	Back	4.50	5.20	5.40	5.60	89.7
	Seat	4.20	4.80	5.00	5.30	79.2
	Arm	1.90	2.20	2.30	2.40	36
K82LH3TLAU	Entire Unit	9.60	11.00	11.50	12.00	186.8
	Back	4.50	5.20	5.40	5.60	89.7
	Seat	4.20	4.80	5.00	5.30	79.2
	Arm	1.00	1.20	1.20	1.30	20
K82LH3TLAU2RAU	Entire Unit	10.50	12.10	12.60	13.10	204.3
	Back	4.50	5.20	5.40	5.60	89.7
	Seat	4.20	4.80	5.00	5.30	79.2
	Arm	1.90	2.20	2.30	2.40	38
K82LH3TLAU8RAU	Entire Unit	10.50	12.10	12.60	13.10	204.3
	Back	4.50	5.20	5.40	5.60	89.7
	Seat	4.20	4.80	5.00	5.30	79.2
	Arm	1.90	2.20	2.30	2.40	36
K82LH3TLAU8TRAU	Entire Unit	10.50	12.10	12.60	13.10	204.3
	Back	4.50	5.20	5.40	5.60	89.7
	Seat	4.20	4.80	5.00	5.30	79.2
	Arm	1.90	2.20	2.30	2.40	36
K82LH3TLAW	Entire Unit	9.60	11.00	11.50	12.00	186.8
	Back	4.50	5.20	5.40	5.60	89.7
	Seat	4.20	4.80	5.00	5.30	79.2
	Arm	1.00	1.20	1.20	1.30	20
K82LH3TLAW2RAW	Entire Unit	10.40	12.00	12.50	13.00	202.3
	Back	4.50	5.20	5.40	5.60	89.7
	Seat	4.20	4.80	5.00	5.30	79.2
	Arm	1.90	2.20	2.30	2.40	38
K82LH3TLAW8RAW	Entire Unit	10.40	12.00	12.50	13.00	202.3
	Back	4.50	5.20	5.40	5.60	89.7
	Seat	4.20	4.80	5.00	5.30	79.2
	Arm	1.80	2.10	2.20	2.30	36
K82LH3TLAWTRAW	Entire Unit	10.50	12.10	12.60	13.10	204.3
	Back	4.50	5.20	5.40	5.60	89.7
	Seat	4.20	4.80	5.00	5.30	79.2
	Arm	1.90	2.20	2.30	2.40	36
K82LH3TRAS	Entire Unit	9.60	11.00	11.50	12.00	186.8
	Back	4.50	5.20	5.40	5.60	89.7
	Seat	4.20	4.80	5.00	5.30	79.2
	Arm	1.00	1.20	1.20	1.30	20
K82LH3TRAT	Entire Unit	9.60	11.00	11.50	12.00	186.8
	Back	4.50	5.20	5.40	5.60	89.7
	Seat	4.20	4.80	5.00	5.30	79.2
	Arm	1.00	1.20	1.20	1.30	20
K82LH3TRAU	Entire Unit	9.60	11.00	11.50	12.00	186.8
	Back	4.50	5.20	5.40	5.60	89.7
	Seat	4.20	4.80	5.00	5.30	79.2
	Arm	1.00	1.20	1.20	1.30	20
K82LH3TRAW	Entire Unit	9.60	11.00	11.50	12.00	186.8
	Back	4.50	5.20	5.40	5.60	89.7
	Seat	4.20	4.80	5.00	5.30	79.2
	Arm	1.00	1.20	1.20	1.30	20

