Whittaker Health

Product Specifications	762
Fabrics and Options	763
Contrasting Fabrics Specifications	764
Product Pages	765
COM Yardage Requirements	797

WHITTAKER HEALTH PRODUCT SPECIFICATIONS

FRAME CONSTRUCTION

- Lounge frame is constructed of $\frac{3}{8}$ " thick OSB, using a lap-joint construction method
- Frames are glued and screwed together
- Moisture barrier is optional for seat, or seat and inside back. Upcharge applies

HANDING DESIGNATION

- Handing designation (left or right of unit) is determined from the user's perspective when seated
- Unit shown is a left corner with convenience arm right

SEAT CONSTRUCTION

- Seats feature a high tension, strip webbing suspension that is stapled to the frame
- Seat upholstery features a wrap-around upholstery method and is stapled into place
- Clean out is standard to make cleaning easy and simple
- Cushions are made of high grade, high resiliency, CFC-free, laminated polyurethane foam
- Seat cushions are $3\frac{1}{4}$ " thick. Back cushions are $4\frac{1}{2}$ "

CONTRASTING FABRIC

- Contrasting fabric may be specified for inner back, outer back, seat, arm, and front panel/accent

ARM CAPS

- Arm caps are available as an option on convenience arms (upcharge applies)
- Available in polyurethane, 3D laminate, solid surface, or wood

ARMS

- Arms are available in convenience and full heights
- Arm frames are constructed of $\frac{1}{2}$ " thick plywood
- Arm tops and outside panels feature $\frac{1}{4}$ " thick, high grade polyurethane foam
- Arms feature a sewn slipcover with French seams that is stapled into place

LEGS

- Legs are 2mm tubular metal and available in several finishes

RAILS

- Side rails are 8mm bar stock
- Front and back rails are 6mm bar stock

POWER/USB MODULE

- Power/USB module is available and can be attached anywhere underneath the unit
- Specified separately for field installation
- Includes a 6' cord with three-prong plug, one power receptacle and two USB ports

GLIDES

- Non-skid, adjustable glides are $\frac{3}{4}$ " in diameter

GANGING BRACKETS

- Two ganging brackets (K82PGB) are required to join two units together
- Lounge models have pre-drilled holes in the base to accept the ganging bracket and small mating piece
- Once brackets are installed, units slide together for a secure connection
- To disconnect, lift up and pull outward on the unit with the smaller, mating pieces
- Assembly instructions available at: kimballhospitality.com

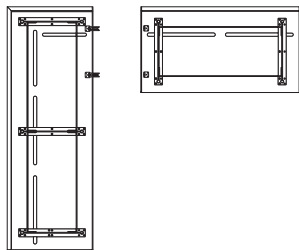
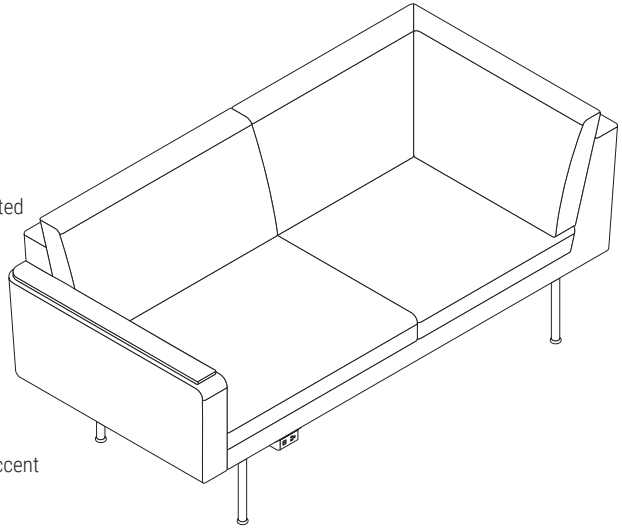

IMPORTANT: Applying upholsteries with horizontal or vertical patterns and stripes on corner units and the backs of units that will be used in a ganging application is discouraged

IMPORTANT: Fabrics reflect light differently when viewed at various angles, creating a natural phenomenon called "flip." Flip is visible on all fabrics and is not considered a defect; it is more easily recognized on fabrics with a nap or shimmer and more apparent on crescent or corner units

SURFACE MATERIALS

See the Kimball Hospitality Surface Materials Reference Guide at kimballhospitality.com for a complete overview of our materials program, including:

- Characteristics of wood
- Special wood finishes
- Customer specified laminate (CSL)
- Customer specified paint (CSP)
- Fabric application and colorways
- Customer's own material (COM) process overview
- Alliance program

ALLIANCE FABRIC PROGRAM

Kimball Hospitality has analyzed each model to most accurately reflect the COM/COL yardage requirements shown on page 797.

The yardage requirement for each model is based on 54" wide fabric and cutting the fabric up the roll.

If repeat is larger than 18", contact Customer Service to confirm the correct amount of yardage required. When ordering 10 or more chairs in the same COM, yardage requirements may be reduced.

Contact Customer Service.

PRICE GRADES A-R

See Surface Materials at www.kimballhospitality.com for a wide variety of graded-in fabrics from Arc-Com, Carnegie, CF Stinson, Designtex, Maharam, Mayer, Momentum, and Ultrafabrics.

FABRIC SAMPLES

If you need samples for presentation(s), contact our alliance partners directly at:

Arc-Com	800.223.5466	arc-com.com
Carnegie	800.727.6770	carnegiefabrics.com
CF Stinson	800.841.6279	cfstinson.com
Designtex	800.221.1540	designtex.com
Maharam	800.645.3943	maharam.com
Mayer	800.428.4415	mayerfabrics.com
Momentum	800.366.6839	memosamples.com
Ultrafabrics	877.309.6648	ultrafabricsllc.com

LEGS

PAINT

462	Cinder
405	Designer White

NON-PAINT*

490	Chrome
552	Gold
553	Rose Gold

*\$276 upcharge

MOISTURE BARRIER

X	No Moisture Barrier
MB1	Seat (\$154 upcharge)
MB2	Seat and Inside Back (\$270 upcharge)

ARM CAPS

WOOD FINISHES

PRICE GROUP 1

BZ	Brazilwood
CO	Canyon
CI	Chai
CC	Cordoba
DF	Driftwood
KN	Kona
MW	Midtown
MH	Mocha
YO	Monterey
PC	Porcini
PB	Portobello
792	Sable
NW	Tuscan
WL	Willow

IMPORTANT: Hardwood finishes on seating are complementary to veneer finishes on casegoods and tables, but may not be a direct match due to the difference in substrates

Contact Customer Service for more information

POLYURETHANE

SOLID

495	Beige
462	Cinder
495	Grey

3D LAMINATE

WOODGRAIN

CO	Canyon
DF	Driftwood
MH	Mocha
YO	Monterey
NW	Tuscan

SOLID SURFACE

STANDARD

7101	Bisque
405	Designer White

PREMIUM*

467	Carbon Concrete
468	Neutral Concrete
464	Peace Grey
469	Weathered Concrete

*\$490 upcharge

EOS*

495	EOS ^{CU} Beige
496	EOS ^{CU} Grey

*\$1324 upcharge

TO ORDER CONTRASTING FABRIC, SPECIFY

WHITTAKER HEALTH

One Seat, Two Seat, and Three Seat Armless Lounge Seating page 765

1. Model Number plus "X"
2. Inner Back Upholstery Grade
3. Inner Back Upholstery Number
4. Outer Back Upholstery Grade
5. Outer Back Upholstery Number
6. Seat Upholstery Grade
7. Seat Upholstery Number
8. Front Panel/Accent Upholstery Grade
9. Front Panel/Accent Upholstery Number
10. Leg Metal Finish Designator
11. Moisture Barrier Optional for Seat, or Seat and Inside Back

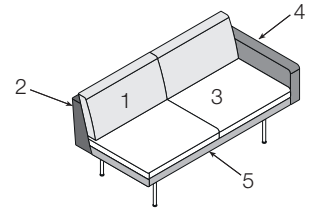

Contrasting fabric may be specified for inner back, outer back, seat, arm, and front panel/accent

One Seat and Two Seat Convenience Arm on Left Lounge page 766

Three Seat Convenience Arm on Left Lounge page 767

One Seat and Two Seat Convenience Arm on Right Lounge page 768

Three Seat Convenience Arm on Right Lounge page 769

One Seat and Two Seat Convenience Arm on Both Sides Lounge page 770

Three Seat Convenience Arm on Both Sides Lounge page 771

1. Model Number plus "X"
2. Inner Back Upholstery Grade
3. Inner Back Upholstery Number
4. Outer Back Upholstery Grade
5. Outer Back Upholstery Number
6. Seat Upholstery Grade
7. Seat Upholstery Number
8. Arm Upholstery Grade
9. Arm Upholstery Number
10. Front Panel/Accent Upholstery Grade
11. Front Panel/Accent Upholstery Number
12. Leg Metal Finish Designator
13. Arm Cap Finish or Color Designator (if applicable)
14. Moisture Barrier Optional for Seat, or Seat and Inside Back

One Seat and Two Seat Full Arm(s) Lounge page 772

Three Seat Full Arm(s) Lounge page 773

Two and Three Seat Interior Arms, No Side Arms Lounge page 774

1. Model Number plus "X"
2. Inner Back Upholstery Grade
3. Inner Back Upholstery Number
4. Outer Back Upholstery Grade
5. Outer Back Upholstery Number
6. Seat Upholstery Grade
7. Seat Upholstery Number
8. Arm Upholstery Grade
9. Arm Upholstery Number
10. Front Panel/Accent Upholstery Grade
11. Front Panel/Accent Upholstery Number
12. Leg Metal Finish Designator
13. Moisture Barrier Optional for Seat, or Seat and Inside Back

Two Seat Interior Arm in Center, Convenience Arm on Left Lounge page 775

Two Seat Interior Arm in Center, Convenience Arm on Right Lounge page 775

Two Seat Interior Arm in Center, Convenience Arm on Both Sides Lounge page 776

1. Model Number plus "X"
2. Inner Back Upholstery Grade
3. Inner Back Upholstery Number
4. Outer Back Upholstery Grade
5. Outer Back Upholstery Number
6. Seat Upholstery Grade
7. Seat Upholstery Number
8. Arm Upholstery Grade
9. Arm Upholstery Number
10. Front Panel/Accent Upholstery Grade
11. Front Panel/Accent Upholstery Number
12. Leg Metal Finish Designator
13. Arm Cap Finish or Color Designator (if applicable)
14. Moisture Barrier Optional for Seat, or Seat and Inside Back

TO ORDER, SPECIFY:

1. Model Number
2. Inner Back Upholstery Grade
3. Inner Back Upholstery Number
4. Outer Back Upholstery Grade
5. Outer Back Upholstery Number
6. Seat Upholstery Grade
7. Seat Upholstery Number
8. Front Panel/Accent Upholstery Grade
9. Front Panel/Accent Upholstery Number
10. Leg Metal Finish Designator
11. Moisture Barrier Optional for Seat, or Seat and Inside Back

- See page 763 for Whittaker Health options
- See pages 797-802 for COM fabric yardage

ARMLESS LOUNGE



One Seat

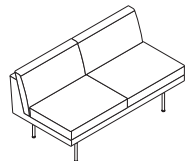

Two Seat

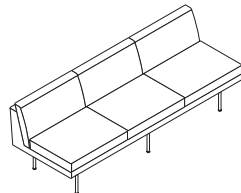

Three Seat

MODEL NO.

ALLIANCE PROGRAM PRICE GRADES

			A	B	C	D	E	F	G	H	I
			J	K	L	M	N	O	P	Q	R
K89L1XATB	One Seat	\$	2969	3106	3213	3323	3440	3577	3655	3804	3930
			4059	4267	4679	4941	5000	5051	5113	5176	5466
K89L2XATB	Two Seat		4627	4846	5016	5192	5381	5600	5726	5964	6165
			6373	6705	7365	7786	7880	7961	8061	8162	8628
K89L3XATB	Three Seat		6356	6677	6924	7182	7457	7778	7961	8311	8603
			8906	9392	10355	10969	11106	11226	11372	11519	12199

DIMENSIONS - ONE SEAT

Width	31¼	Seat Height	18½	Weight	75
Depth	29¾	Seat Depth	20½	Cubic Ft.	11.00
Height	29⅜	Seat Width	27¾		

DIMENSIONS - TWO SEAT

Width	55½	Seat Height	18½	Weight	125
Depth	29¾	Seat Depth	20½	Cubic Ft.	36.00
Height	29⅜	Seat Width	55½		

DIMENSIONS - THREE SEAT

Width	82½	Seat Height	18½	Weight	199
Depth	29¾	Seat Depth	20½	Cubic Ft.	53.00
Height	29⅜	Seat Width	82½		

- Contrasting fabric option – specify X (i.e., K89L3XATBX); see page 764. For list pricing, use your electronic specification tool or contact customer service
- Weight Limit 253 lbs.
- Tight-back
- Clean out
- 2mm tubular metal legs
- Non-skid, adjustable glides

WHITTAKER HEALTH

TO ORDER, SPECIFY:

1. Model Number
2. Inner Back Upholstery Grade
3. Inner Back Upholstery Number
4. Outer Back Upholstery Grade
5. Outer Back Upholstery Number
6. Seat Upholstery Grade
7. Seat Upholstery Number
8. Arm Upholstery Grade
9. Arm Upholstery Number
10. Front Panel/Accent Upholstery Grade
11. Front Panel/Accent Upholstery Number
12. Leg Metal Finish Designator
13. Arm Cap Finish or Color Designator (if applicable)
14. Moisture Barrier Optional for Seat, or Seat and Inside Back

- See page 763 for Whittaker Health options
- See pages 797-802 for COM fabric yardage

ONE SEAT CONVENIENCE ARM ON LEFT LOUNGE

MODEL NO.

ALLIANCE PROGRAM PRICE GRADES

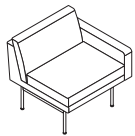

No Arm Cap

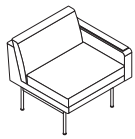

Arm Cap

			A	B	C	D	E	F	G	H	I
			J	K	L	M	N	O	P	Q	R
K89L1CVALUTB	No Arm Cap	\$	3568	3754	3900	4049	4209	4396	4502	4705	4877
			5052	5336	5897	6254	6334	6404	6488	6574	6969
K89L1CVALACWTB	Wood Arm Cap		3621	3807	3953	4102	4262	4449	4555	4758	4930
			5105	5389	5950	6307	6387	6457	6541	6627	7022
K89L1CVALACPTB	Polyurethane Arm Cap		3653	3839	3985	4134	4294	4481	4587	4790	4962
			5137	5421	5982	6339	6419	6489	6573	6659	7054
K89L1CVALACTTB	3D Laminate Arm Cap		3780	3966	4112	4261	4421	4608	4714	4917	5089
			5264	5548	6109	6466	6546	6616	6700	6786	7181
K89L1CVALACSTB	Solid Surface Arm Cap		4000	4186	4332	4481	4641	4828	4934	5137	5309
			5484	5768	6329	6686	6766	6836	6920	7006	7401

DIMENSIONS

Width	31¼	Seat Height	18½	Arm Height		Weight	86
Depth	29¾	Seat Depth	20½	No Arm Cap	22½	Cubic Ft.	21.00
Height	29⅜	Seat Width	27¾	Arm Cap	22⅞		
				Arm Width	3½		

- Contrasting fabric option – specify X (i.e., K89L1CVALUTBX); see page 764. For list pricing, use your electronic specification tool or contact customer service
- Weight Limit 253 lbs.
- Tight-back
- Clean out
- 2mm tubular metal legs
- Non-skid, adjustable glides
- Arm cap on applicable models

TWO SEAT CONVENIENCE ARM ON LEFT LOUNGE

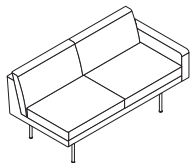

No Arm Cap

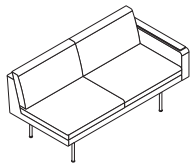

Arm Cap

			A	B	C	D	E	F	G	H	I
			J	K	L	M	N	O	P	Q	R
K89L2CVALUTB	No Arm Cap	\$	5192	5456	5661	5873	6100	6364	6515	6802	7044
			7294	7694	8489	8995	9108	9206	9327	9448	10009
K89L2CVALACWTB	Wood Arm Cap		5248	5512	5717	5929	6156	6420	6571	6858	7100
			7350	7750	8545	9051	9164	9262	9383	9504	10065
K89L2CVALACPTB	Polyurethane Arm Cap		5281	5545	5750	5962	6189	6453	6604	6891	7133
			7383	7783	8578	9084	9197	9295	9416	9537	10098
K89L2CVALACTTB	3D Laminate Arm Cap		5409	5673	5878	6090	6317	6581	6732	7019	7261
			7511	7911	8706	9212	9325	9423	9544	9665	10226
K89L2CVALACSTB	Solid Surface Arm Cap		5634	5898	6103	6315	6542	6806	6957	7244	7486
			7736	8136	8931	9437	9550	9648	9769	9890	10451

DIMENSIONS

Width	58½	Seat Height	18½	Arm Height		Weight	133
Depth	29¾	Seat Depth	20½	No Arm Cap	22½	Cubic Ft.	38.00
Height	29⅜	Seat Width	55½	Arm Cap	22⅞		
				Arm Width	3½		

- Contrasting fabric option – specify X (i.e., K89L2CVALUTBX); see page 764. For list pricing, use your electronic specification tool or contact customer service
- Weight Limit 253 lbs.
- Tight-back
- Clean out
- 2mm tubular metal legs
- Non-skid, adjustable glides
- Arm cap on applicable models

TO ORDER, SPECIFY:

1. Model Number
2. Inner Back Upholstery Grade
3. Inner Back Upholstery Number
4. Outer Back Upholstery Grade
5. Outer Back Upholstery Number
6. Seat Upholstery Grade
7. Seat Upholstery Number
8. Arm Upholstery Grade
9. Arm Upholstery Number
10. Front Panel/Accent Upholstery Grade
11. Front Panel/Accent Upholstery Number
12. Leg Metal Finish Designator
13. Arm Cap Finish or Color Designator (if applicable)
14. Moisture Barrier Optional for Seat, or Seat and Inside Back

- See page 763 for Whittaker Health options
- See pages 797-802 for COM fabric yardage

**THREE SEAT CONVENIENCE
ARM ON LEFT LOUNGE**

**MODEL
NO.**

ALLIANCE PROGRAM PRICE GRADES

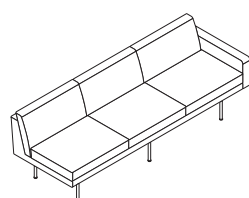

No Arm Cap

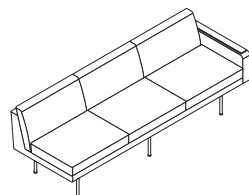

Arm Cap

			A	B	C	D	E	F	G	H	I
			J	K	L	M	N	O	P	Q	R
K89L3CVALUTB	No Arm Cap	\$	6863	7207	7473	7749	8045	8389	8586	8959	9275
			9599	10121	11154	11814	11960	12089	12246	12403	13131
K89L3CVALACWTB	Wood Arm Cap		6918	7262	7528	7804	8100	8444	8641	9014	9330
			9654	10176	11209	11869	12015	12144	12301	12458	13186
K89L3CVALACPTB	Polyurethane Arm Cap		6951	7295	7561	7837	8133	8477	8674	9047	9363
			9687	10209	11242	11902	12048	12177	12334	12491	13219
K89L3CVALACTTB	3D Laminate Arm Cap		7077	7421	7687	7963	8259	8603	8800	9173	9489
			9813	10335	11368	12028	12174	12303	12460	12617	13345
K89L3CVALACSTB	Solid Surface Arm Cap		7304	7648	7914	8190	8486	8830	9027	9400	9716
			10040	10562	11595	12255	12401	12530	12687	12844	13572

DIMENSIONS

Width	86	Seat Height	18 $\frac{1}{2}$	Arm Height		Weight	206
Depth	29 $\frac{3}{4}$	Seat Depth	20 $\frac{1}{4}$	No Arm Cap	22 $\frac{3}{4}$	Cubic Ft.	56.00
Height	29 $\frac{3}{16}$	Seat Width	82 $\frac{1}{2}$	Arm Cap	22 $\frac{1}{4}$		
				Arm Width	3 $\frac{1}{2}$		

- Contrasting fabric option – specify X (i.e., K89L3CVALUTBX); see page 764. For list pricing, use your electronic specification tool or contact customer service
- Weight Limit 253 lbs.
- Tight-back
- Clean out
- 2mm tubular metal legs
- Non-skid, adjustable glides
- Arm cap on applicable models

WHITTAKER HEALTH

TO ORDER, SPECIFY:

1. Model Number
2. Inner Back Upholstery Grade
3. Inner Back Upholstery Number
4. Outer Back Upholstery Grade
5. Outer Back Upholstery Number
6. Seat Upholstery Grade
7. Seat Upholstery Number
8. Arm Upholstery Grade
9. Arm Upholstery Number
10. Front Panel/Accent Upholstery Grade
11. Front Panel/Accent Upholstery Number
12. Leg Metal Finish Designator
13. Arm Cap Finish or Color Designator (if applicable)
14. Moisture Barrier Optional for Seat, or Seat and Inside Back

- See page 763 for Whittaker Health options
- See pages 797-802 for COM fabric yardage

ONE SEAT CONVENIENCE ARM ON RIGHT LOUNGE

MODEL NO.

ALLIANCE PROGRAM PRICE GRADES

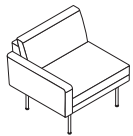

No Arm Cap

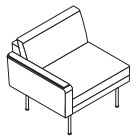

Arm Cap

			A	B	C	D	E	F	G	H	I
			J	K	L	M	N	O	P	Q	R
K89L1CVARUTB	No Arm Cap	\$	3568	3754	3900	4049	4209	4396	4502	4705	4877
			5052	5336	5897	6254	6334	6404	6488	6574	6969
K89L1CVARACWTB	Wood Arm Cap		3621	3807	3953	4102	4262	4449	4555	4758	4930
			5105	5389	5950	6307	6387	6457	6541	6627	7022
K89L1CVARACPTB	Polyurethane Arm Cap		3653	3839	3985	4134	4294	4481	4587	4790	4962
			5137	5421	5982	6339	6419	6489	6573	6659	7054
K89L1CVARACTTB	3D Laminate Arm Cap		3780	3966	4112	4261	4421	4608	4714	4917	5089
			5264	5548	6109	6466	6546	6616	6700	6786	7181
K89L1CVARACSTB	Solid Surface Arm Cap		4000	4186	4332	4481	4641	4828	4934	5137	5309
			5484	5768	6329	6686	6766	6836	6920	7006	7401

DIMENSIONS

Width	31 $\frac{1}{4}$	Seat Height	18 $\frac{1}{8}$	Arm Height		Weight	86
Depth	29 $\frac{3}{4}$	Seat Depth	20 $\frac{1}{16}$	No Arm Cap	22 $\frac{3}{16}$	Cubic Ft.	21.00
Height	29 $\frac{9}{16}$	Seat Width	27 $\frac{3}{4}$	Arm Cap	22 $\frac{1}{16}$		
				Arm Width	3 $\frac{1}{2}$		

- Contrasting fabric option – specify X (i.e., K89L1CVARUTBX); see page 764. For list pricing, use your electronic specification tool or contact customer service
- Weight Limit 253 lbs.
- Tight-back
- Clean out
- 2mm tubular metal legs
- Non-skid, adjustable glides
- Arm cap on applicable models

TWO SEAT CONVENIENCE ARM ON RIGHT LOUNGE

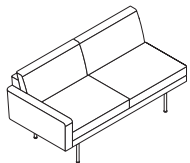

No Arm Cap

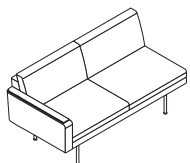

Arm Cap

			A	B	C	D	E	F	G	H	I
			J	K	L	M	N	O	P	Q	R
K89L2CVARUTB	No Arm Cap	\$	5192	5456	5661	5873	6100	6364	6515	6802	7044
			7294	7694	8489	8995	9108	9206	9327	9448	10009
K89L2CVARACWTB	Wood Arm Cap		5248	5512	5717	5929	6156	6420	6571	6858	7100
			7350	7750	8545	9051	9164	9262	9383	9504	10065
K89L2CVARACPTB	Polyurethane Arm Cap		5281	5545	5750	5962	6189	6453	6604	6891	7133
			7383	7783	8578	9084	9197	9295	9416	9537	10098
K89L2CVARACTTB	3D Laminate Arm Cap		5409	5673	5878	6090	6317	6581	6732	7019	7261
			7511	7911	8706	9212	9325	9423	9544	9665	10226
K89L2CVARACSTB	Solid Surface Arm Cap		5634	5898	6103	6315	6542	6806	6957	7244	7486
			7736	8136	8931	9437	9550	9648	9769	9890	10451

DIMENSIONS

Width	58 $\frac{1}{2}$	Seat Height	18 $\frac{1}{8}$	Arm Height		Weight	133
Depth	29 $\frac{3}{4}$	Seat Depth	20 $\frac{1}{16}$	No Arm Cap	22 $\frac{3}{16}$	Cubic Ft.	38.00
Height	29 $\frac{9}{16}$	Seat Width	55 $\frac{1}{2}$	Arm Cap	22 $\frac{1}{16}$		
				Arm Width	3 $\frac{1}{2}$		

- Contrasting fabric option – specify X (i.e., K89L2CVARUTBX); see page 764. For list pricing, use your electronic specification tool or contact customer service
- Weight Limit 253 lbs.
- Tight-back
- Clean out
- 2mm tubular metal legs
- Non-skid, adjustable glides
- Arm cap on applicable models

TO ORDER, SPECIFY:

1. Model Number
2. Inner Back Upholstery Grade
3. Inner Back Upholstery Number
4. Outer Back Upholstery Grade
5. Outer Back Upholstery Number
6. Seat Upholstery Grade
7. Seat Upholstery Number
8. Arm Upholstery Grade
9. Arm Upholstery Number
10. Front Panel/Accent Upholstery Grade
11. Front Panel/Accent Upholstery Number
12. Leg Metal Finish Designator
13. Arm Cap Finish or Color Designator (if applicable)
14. Moisture Barrier Optional for Seat, or Seat and Inside Back

- See page 763 for Whittaker Health options
- See pages 797-802 for COM fabric yardage

**THREE SEAT CONVENIENCE
ARM ON RIGHT LOUNGE**

**MODEL
NO.**

ALLIANCE PROGRAM PRICE GRADES

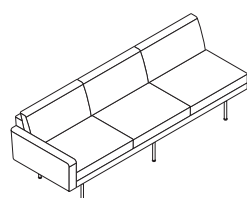

No Arm Cap

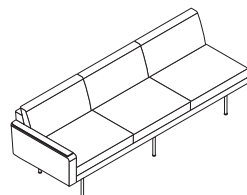

Arm Cap

		A	B	C	D	E	F	G	H	I
		J	K	L	M	N	O	P	Q	R
K89L3CVARUTB	No Arm Cap	\$ 6863	7207	7473	7749	8045	8389	8586	8959	9275
		9599	10121	11154	11814	11960	12089	12246	12403	13131
K89L3CVARACWTB	Wood Arm Cap	6918	7262	7528	7804	8100	8444	8641	9014	9330
		9654	10176	11209	11869	12015	12144	12301	12458	13186
K89L3CVARACPTB	Polyurethane Arm Cap	6951	7295	7561	7837	8133	8477	8674	9047	9363
		9687	10209	11242	11902	12048	12177	12334	12491	13219
K89L3CVARACTTB	3D Laminate Arm Cap	7077	7421	7687	7963	8259	8603	8800	9173	9489
		9813	10335	11368	12028	12174	12303	12460	12617	13345
K89L3CVARACSTB	Solid Surface Arm Cap	7304	7648	7914	8190	8486	8830	9027	9400	9716
		10040	10562	11595	12255	12401	12530	12687	12844	13572

DIMENSIONS

Width	86	Seat Height	18 $\frac{1}{2}$	Arm Height		Weight	206
Depth	29 $\frac{3}{4}$	Seat Depth	20 $\frac{1}{4}$	No Arm Cap	22 $\frac{3}{4}$	Cubic Ft.	56.00
Height	29 $\frac{3}{16}$	Seat Width	82 $\frac{1}{2}$	Arm Cap	22 $\frac{1}{4}$		
				Arm Width	3 $\frac{1}{2}$		

- Contrasting fabric option – specify X (i.e., K89L3CVARUTBX); see page 764. For list pricing, use your electronic specification tool or contact customer service
- Weight Limit 253 lbs.
- Tight-back
- Clean out
- 2mm tubular metal legs
- Non-skid, adjustable glides
- Arm cap on applicable models

WHITTAKER HEALTH

TO ORDER, SPECIFY:

1. Model Number
2. Inner Back Upholstery Grade
3. Inner Back Upholstery Number
4. Outer Back Upholstery Grade
5. Outer Back Upholstery Number
6. Seat Upholstery Grade
7. Seat Upholstery Number
8. Arm Upholstery Grade
9. Arm Upholstery Number
10. Front Panel/Accent Upholstery Grade
11. Front Panel/Accent Upholstery Number
12. Leg Metal Finish Designator
13. Arm Cap Finish or Color Designator (if applicable)
14. Moisture Barrier Optional for Seat, or Seat and Inside Back

- See page 763 for Whittaker Health options
- See pages 797-802 for COM fabric yardage

ONE SEAT CONVENIENCE ARM ON BOTH SIDES LOUNGE

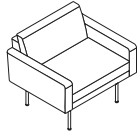

No Arm Caps

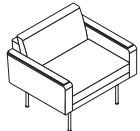

Arm Caps

MODEL NO.

ALLIANCE PROGRAM PRICE GRADES

			A	B	C	D	E	F	G	H	I
			J	K	L	M	N	O	P	Q	R
K89L1CVABUTB	No Arm Cap	\$	3926	4116	4265	4417	4580	4771	4879	5087	5262
			5441	5730	6303	6667	6749	6820	6907	6994	7397
K89L1CVABACWTB	Wood Arm Cap		4008	4198	4347	4499	4662	4853	4961	5169	5344
			5523	5812	6385	6749	6831	6902	6989	7076	7479
K89L1CVABACPTB	Polyurethane Arm Cap		4091	4281	4430	4582	4745	4936	5044	5252	5427
			5606	5895	6468	6832	6914	6985	7072	7159	7562
K89L1CVABACTTB	3D Laminate Arm Cap		4345	4535	4684	4836	4999	5190	5298	5506	5681
			5860	6149	6722	7086	7168	7239	7326	7413	7816
K89L1CVABACSTB	Solid Surface Arm Cap		4795	4985	5134	5286	5449	5640	5748	5956	6131
			6310	6599	7172	7536	7618	7689	7776	7863	8266

DIMENSIONS

Width	34 $\frac{3}{4}$	Seat Height	18 $\frac{1}{2}$	Arm Height		Weight	94
Depth	29 $\frac{3}{4}$	Seat Depth	20 $\frac{1}{4}$	No Arm Cap	22 $\frac{1}{4}$	Cubic Ft.	23.00
Height	29 $\frac{3}{16}$	Seat Width	27 $\frac{3}{4}$	Arm Cap	22 $\frac{1}{4}$		
				Arm Width	3 $\frac{1}{2}$		

- Contrasting fabric option – specify X (i.e., K89L1CVABUTBX); see page 764. For list pricing, use your electronic specification tool or contact customer service
- Weight Limit 253 lbs.
- Tight-back
- Clean out
- 2mm tubular metal legs
- Non-skid, adjustable glides
- Arm cap on applicable models

TWO SEAT CONVENIENCE ARM ON BOTH SIDES LOUNGE

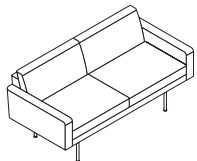

No Arm Caps

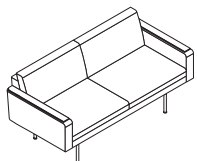

Arm Caps

			A	B	C	D	E	F	G	H	I
			J	K	L	M	N	O	P	Q	R
K89L2CVABUTB	No Arm Cap	\$	5558	5830	6042	6260	6495	6768	6924	7221	7471
			7729	8142	8963	9486	9603	9704	9829	9954	10533
K89L2CVABACWTB	Wood Arm Cap		5672	5944	6156	6374	6609	6882	7038	7335	7585
			7843	8256	9077	9600	9717	9818	9943	10068	10647
K89L2CVABACPTB	Polyurethane Arm Cap		5736	6008	6220	6438	6673	6946	7102	7399	7649
			7907	8320	9141	9664	9781	9882	10007	10132	10711
K89L2CVABACTTB	3D Laminate Arm Cap		5986	6258	6470	6688	6923	7196	7352	7649	7899
			8157	8570	9391	9914	10031	10132	10257	10382	10961
K89L2CVABACSTB	Solid Surface Arm Cap		6438	6710	6922	7140	7375	7648	7804	8101	8351
			8609	9022	9843	10366	10483	10584	10709	10834	11413

DIMENSIONS

Width	62 $\frac{1}{2}$	Seat Height	18 $\frac{1}{2}$	Arm Height		Weight	141
Depth	29 $\frac{3}{4}$	Seat Depth	20 $\frac{1}{4}$	No Arm Cap	22 $\frac{1}{4}$	Cubic Ft.	41.00
Height	29 $\frac{3}{16}$	Seat Width	55 $\frac{1}{2}$	Arm Cap	22 $\frac{1}{4}$		
				Arm Width	3 $\frac{1}{2}$		

- Contrasting fabric option – specify X (i.e., K89L2CVABUTBX); see page 764. For list pricing, use your electronic specification tool or contact customer service
- Weight Limit 253 lbs.
- Tight-back
- Clean out
- 2mm tubular metal legs
- Non-skid, adjustable glides
- Arm cap on applicable models

TO ORDER, SPECIFY:

1. Model Number
2. Inner Back Upholstery Grade
3. Inner Back Upholstery Number
4. Outer Back Upholstery Grade
5. Outer Back Upholstery Number
6. Seat Upholstery Grade
7. Seat Upholstery Number
8. Arm Upholstery Grade
9. Arm Upholstery Number
10. Front Panel/Accent Upholstery Grade
11. Front Panel/Accent Upholstery Number
12. Leg Metal Finish Designator
13. Arm Cap Finish or Color Designator (if applicable)
14. Moisture Barrier Optional for Seat, or Seat and Inside Back

- See page 763 for Whittaker Health options
- See pages 797-802 for COM fabric yardage

**THREE SEAT CONVENIENCE
ARM ON BOTH SIDES
LOUNGE**

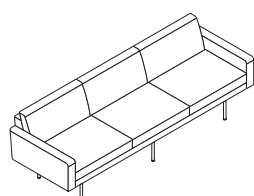

No Arm Caps

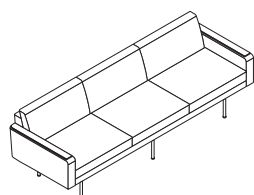

Arm Caps

**MODEL
NO.**

ALLIANCE PROGRAM PRICE GRADES

			A	B	C	D	E	F	G	H	I
			J	K	L	M	N	O	P	Q	R
K89L3CVABUTB	No Arm Cap	\$	7223	7575	7848	8130	8434	8787	8989	9372	9696
			10028	10563	11622	12299	12449	12581	12742	12903	13649
K89L3CVABACWTB	Wood Arm Cap		7334	7686	7959	8241	8545	8898	9100	9483	9807
			10139	10674	11733	12410	12560	12692	12853	13014	13760
K89L3CVABACPTB	Polyurethane Arm Cap		7401	7753	8026	8308	8612	8965	9167	9550	9874
			10206	10741	11800	12477	12627	12759	12920	13081	13827
K89L3CVABACTTB	3D Laminate Arm Cap		7654	8006	8279	8561	8865	9218	9420	9803	10127
			10459	10994	12053	12730	12880	13012	13173	13334	14080
K89L3CVABACSTB	Solid Surface Arm Cap		8106	8458	8731	9013	9317	9670	9872	10255	10579
			10911	11446	12505	13182	13332	13464	13625	13786	14532

DIMENSIONS

Width	89½	Seat Height	18¾	Arm Height		Weight	214
Depth	29¾	Seat Depth	20¼	No Arm Cap	22¾	Cubic Ft.	58.00
Height	29¾	Seat Width	82½	Arm Cap	22¼		
				Arm Width	3½		

- Contrasting fabric option – specify X (i.e., K89L3CVABUTBX); see page 764. For list pricing, use your electronic specification tool or contact customer service
- Weight Limit 253 lbs.
- Tight-back
- Clean out
- 2mm tubular metal legs
- Non-skid, adjustable glides
- Arm cap on applicable models

TO ORDER, SPECIFY:

1. Model Number
2. Inner Back Upholstery Grade
3. Inner Back Upholstery Number
4. Outer Back Upholstery Grade
5. Outer Back Upholstery Number
6. Seat Upholstery Grade
7. Seat Upholstery Number
8. Arm Upholstery Grade
9. Arm Upholstery Number
10. Front Panel/Accent Upholstery Grade
11. Front Panel/Accent Upholstery Number
12. Leg Metal Finish Designator
13. Moisture Barrier Optional for Seat, or Seat and Inside Back

- See page 763 for Whittaker Health options
- See pages 797-802 for COM fabric yardage

ONE SEAT FULL ARM(S) LOUNGE

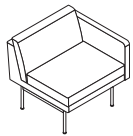

Full Arm on Left

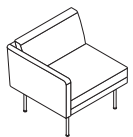

Full Arm on Right

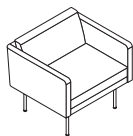

Full Arm on Both Sides

MODEL NO.

ALLIANCE PROGRAM PRICE GRADES

			A	B	C	D	E	F	G	H	I
			J	K	L	M	N	O	P	Q	R
K89L1FALTB	Full Arm on Left	\$	3575	3761	3907	4056	4216	4403	4509	4712	4884
			5059	5343	5904	6261	6341	6411	6495	6581	6976
K89L1FARTB	Full Arm on Right		3575	3761	3907	4056	4216	4403	4509	4712	4884
			5059	5343	5904	6261	6341	6411	6495	6581	6976
K89L1FABTB	Full Arm on Both Sides		3945	4155	4318	4486	4665	4875	4995	5223	5415
			5613	5931	6562	6963	7053	7131	7227	7323	7767

DIMENSIONS

Width	29¾	Seat Height	18¾	Arm Height	26¾	Weight	86
Depth	29¾	Seat Depth	20⅞	Arm Width	2	Weight Both Sides	93
Height	29⅜	Seat Width	27¾			Cubic Ft.	20.00
						Cubic Ft. Both Sides	22.00

- Contrasting fabric option – specify X (i.e., K89L1FALTBX); see page 764. For list pricing, use your electronic specification tool or contact customer service
- Weight Limit 253 lbs.
- Tight-back
- Clean out
- 2mm tubular metal legs
- Non-skid, adjustable glides

TWO SEAT FULL ARM(S) LOUNGE

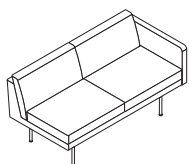

Full Arm on Left

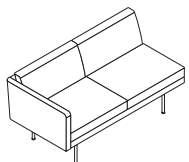

Full Arm on Right

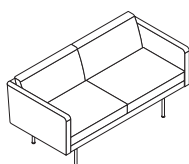

Full Arm on Both Sides

			A	B	C	D	E	F	G	H	I
			J	K	L	M	N	O	P	Q	R
K89L2FALTB	Full Arm on Left	\$	5220	5488	5697	5912	6144	6413	6567	6859	7106
			7360	7768	8577	9093	9208	9308	9430	9554	10125
K89L2FARTB	Full Arm on Right		5220	5488	5697	5912	6144	6413	6567	6859	7106
			7360	7768	8577	9093	9208	9308	9430	9554	10125
K89L2FABTB	Full Arm on Both Sides		5626	5918	6144	6378	6629	6921	7089	7406	7673
			7950	8392	9271	9831	9956	10064	10198	10332	10952

DIMENSIONS

Width	57¾	Seat Height	18¾	Arm Height	26¾	Weight	133
Depth	29¾	Seat Depth	20⅞	Arm Width	2	Weight Both Sides	140
Height	29⅜	Seat Width	55¾			Cubic Ft.	37.00
						Cubic Ft. Both Sides	39.00

- Contrasting fabric option – specify X (i.e., K89L2FALTBX); see page 764. For list pricing, use your electronic specification tool or contact customer service
- Weight Limit 253 lbs.
- Tight-back
- Clean out
- 2mm tubular metal legs
- Non-skid, adjustable glides

TO ORDER, SPECIFY:

1. Model Number
2. Inner Back Upholstery Grade
3. Inner Back Upholstery Number
4. Outer Back Upholstery Grade
5. Outer Back Upholstery Number
6. Seat Upholstery Grade
7. Seat Upholstery Number
8. Arm Upholstery Grade
9. Arm Upholstery Number
10. Front Panel/Accent Upholstery Grade
11. Front Panel/Accent Upholstery Number
12. Leg Metal Finish Designator
13. Moisture Barrier Optional for Seat, or Seat and Inside Back

- See page 763 for Whittaker Health options
- See pages 797-802 for COM fabric yardage

THREE SEAT FULL ARM(S) LOUNGE

MODEL NO.

ALLIANCE PROGRAM PRICE GRADES

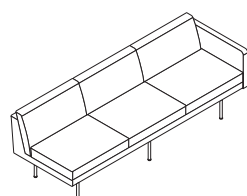

Full Arm on Left

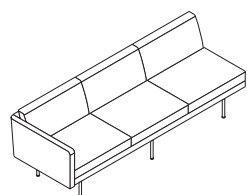

Full Arm on Right

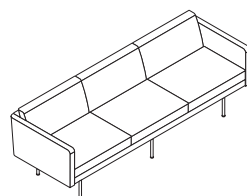

Full Arm on Both Sides

			A	B	C	D	E	F	G	H	I
			J	K	L	M	N	O	P	Q	R
K89L3FALTB	Full Arm on Left	\$	6681	7029	7299	7578	7879	8228	8428	8806	9127
			9455	9985	11032	11702	11850	11981	12139	12299	13037
K89L3FARTB	Full Arm on Right		6681	7029	7299	7578	7879	8228	8428	8806	9127
			9455	9985	11032	11702	11850	11981	12139	12299	13037
K89L3FABTB	Full Arm on Both Sides		6737	7109	7396	7694	8014	8386	8600	9003	9344
			9695	10259	11376	12090	12248	12387	12557	12727	13514

DIMENSIONS

Width	84½	Seat Height	18½	Arm Height	26½	Weight	206
Depth	29¾	Seat Depth	20½	Arm Width	2	Weight Both Sides	214
Height	29⅜	Seat Width	82½			Cubic Ft.	55.00
						Cubic Ft. Both Sides	56.00

- Contrasting fabric option – specify X (i.e., K89L3FALTBX); see page 764. For list pricing, use your electronic specification tool or contact customer service
- Weight Limit 253 lbs.
- Tight-back
- Clean out
- 2mm tubular metal legs
- Non-skid, adjustable glides

TO ORDER, SPECIFY:

1. Model Number
2. Inner Back Upholstery Grade
3. Inner Back Upholstery Number
4. Outer Back Upholstery Grade
5. Outer Back Upholstery Number
6. Seat Upholstery Grade
7. Seat Upholstery Number
8. Arm Upholstery Grade
9. Arm Upholstery Number
10. Front Panel/Accent Upholstery Grade
11. Front Panel/Accent Upholstery Number
12. Leg Metal Finish Designator
13. Moisture Barrier Optional for Seat, or Seat and Inside Back

- See page 763 for Whittaker Health options
- See pages 797-802 for COM fabric yardage

WHITTAKER HEALTH

TWO SEAT INTERIOR ARMS, NO SIDE ARMS LOUNGE

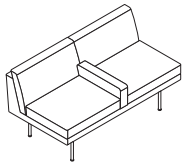

MODEL NO.

ALLIANCE PROGRAM PRICE GRADES

		A	B	C	D	E	F	G	H	I
		J	K	L	M	N	O	P	Q	R
K89L2XAITB	Interior Arm Center	\$ 4572	4826	5024	5227	5445	5700	5846	6122	6355
		6596	6981	7746	8234	8343	8437	8553	8670	9209

DIMENSIONS

Width	55%	Seat Height	18%	Arm Height	26%	Weight	132
Depth	29%	Seat Depth	20%	Arm Width	3 1/2	Cubic Ft.	36.00
Height	29 3/16	Seat Width	55%				

- Contrasting fabric option – specify X (i.e., K89L2XAITBX); see page 764. For list pricing, use your electronic specification tool or contact customer service
- Weight Limit 253 lbs.
- Tight-back
- Clean out
- 2mm tubular metal legs
- Non-skid, adjustable glides

THREE SEAT INTERIOR ARMS, NO SIDE ARMS LOUNGE

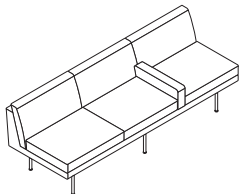

Interior Arm Left

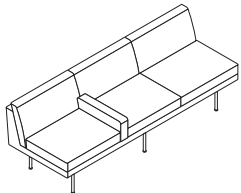

Interior Arm Right

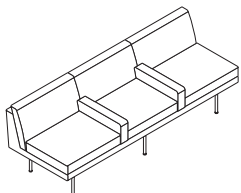

Interior Arms Left and Right

		A	B	C	D	E	F	G	H	I
		J	K	L	M	N	O	P	Q	R
K89L3XAILTB	Interior Arm Left	\$ 6130	6472	6736	7010	7304	7646	7843	8213	8527
		8849	9368	10394	11051	11196	11324	11479	11636	12359
K89L3XAIRTB	Interior Arm Right	6130	6472	6736	7010	7304	7646	7843	8213	8527
		8849	9368	10394	11051	11196	11324	11479	11636	12359
K89L3XAIBTB	Interior Arms Left and Right	6139	6481	6745	7019	7313	7655	7852	8222	8536
		8858	9377	10403	11060	11205	11333	11488	11645	12368

DIMENSIONS

Width	82 1/2	Seat Height	18%	Arm Height	26%	Weight	206
Depth	29%	Seat Depth	20%	Arm Width	2	Weight Both Sides	213
Height	29 3/16	Seat Width	82 1/2			Cubic Ft.	53.00

- Contrasting fabric option – specify X (i.e., K89L3XAILTBX); see page 764. For list pricing, use your electronic specification tool or contact customer service
- Weight Limit 253 lbs.
- Tight-back
- Clean out
- 2mm tubular metal legs
- Non-skid, adjustable glides

TO ORDER, SPECIFY:

- 1. Model Number
- 2. Inner Back Upholstery Grade
- 3. Inner Back Upholstery Number
- 4. Outer Back Upholstery Grade
- 5. Outer Back Upholstery Number
- 6. Seat Upholstery Grade
- 7. Seat Upholstery Number
- 8. Arm Upholstery Grade
- 9. Arm Upholstery Number
- 10. Front Panel/Accent Upholstery Grade
- 11. Front Panel/Accent Upholstery Number
- 12. Leg Metal Finish Designator
- 13. Arm Cap Finish or Color Designator (if applicable)
- 14. Moisture Barrier Optional for Seat, or Seat and Inside Back

- See page 763 for Whittaker Health options
- See pages 797-802 for COM fabric yardage

TWO SEAT INTERIOR ARM IN CENTER, CONVENIENCE ARM ON LEFT LOUNGE

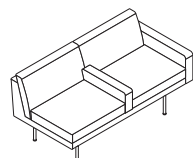

No Arm Caps

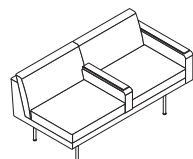

Arm Caps

MODEL NO.

ALLIANCE PROGRAM PRICE GRADES

		A	B	C	D	E	F	G	H	I
		J	K	L	M	N	O	P	Q	R
K89L2CVALIUTB	No Arm Caps	\$ 5294	5562	5771	5986	6218	6487	6641	6933	7180
		7434	7842	8651	9167	9282	9382	9504	9628	10199
K89L2CVALIACWTB	Wood Arm Caps	5398	5666	5875	6090	6322	6591	6745	7037	7284
		7538	7946	8755	9271	9386	9486	9608	9732	10303
K89L2CVALIACPTB	Polyurethane Arm Caps	5472	5740	5949	6164	6396	6665	6819	7111	7358
		7612	8020	8829	9345	9460	9560	9682	9806	10377
K89L2CVALIACCTB	3D Laminate Arm Caps	6147	6415	6624	6839	7071	7340	7494	7786	8033
		8287	8695	9504	10020	10135	10235	10357	10481	11052
K89L2CVALIACSTB	Solid Surface Arm Caps	6396	6664	6873	7088	7320	7589	7743	8035	8282
		8536	8944	9753	10269	10384	10484	10606	10730	11301

DIMENSIONS

Width	58 $\frac{3}{4}$	Seat Height	18 $\frac{1}{2}$	Arm Height		Weight	140
Depth	29 $\frac{3}{4}$	Seat Depth	20 $\frac{1}{4}$	No Arm Cap	22 $\frac{3}{8}$	Cubic Ft.	38.00
Height	29 $\frac{1}{2}$	Seat Width	25 $\frac{1}{2}$	Arm Cap	22 $\frac{1}{4}$		
				Arm Width	3 $\frac{1}{2}$		

- Contrasting fabric option – specify X (i.e., K89L2CVALIUTBX); see page 764. For list pricing, use your electronic specification tool or contact customer service
- Weight Limit 253 lbs.
- Tight-back
- Clean out
- 2mm tubular metal legs
- Non-skid, adjustable glides
- Arm caps on applicable models

TWO SEAT INTERIOR ARM IN CENTER, CONVENIENCE ARM ON RIGHT LOUNGE

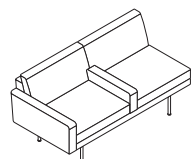

No Arm Caps

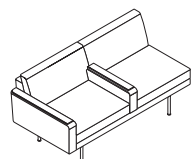

Arm Caps

		A	B	C	D	E	F	G	H	I
		J	K	L	M	N	O	P	Q	R
K89L2CVARIUTB	No Arm Caps	\$ 5294	5562	5771	5986	6218	6487	6641	6933	7180
		7434	7842	8651	9167	9282	9382	9504	9628	10199
K89L2CVARIACWTB	Wood Arm Caps	5398	5666	5875	6090	6322	6591	6745	7037	7284
		7538	7946	8755	9271	9386	9486	9608	9732	10303
K89L2CVARIACPTB	Polyurethane Arm Caps	5472	5740	5949	6164	6396	6665	6819	7111	7358
		7612	8020	8829	9345	9460	9560	9682	9806	10377
K89L2CVARIACCTB	3D Laminate Arm Caps	6147	6415	6624	6839	7071	7340	7494	7786	8033
		8287	8695	9504	10020	10135	10235	10357	10481	11052
K89L2CVARIACSTB	Solid Surface Arm Caps	6396	6664	6873	7088	7320	7589	7743	8035	8282
		8536	8944	9753	10269	10384	10484	10606	10730	11301

DIMENSIONS

Width	58 $\frac{3}{4}$	Seat Height	18 $\frac{1}{2}$	Arm Height		Weight	140
Depth	29 $\frac{3}{4}$	Seat Depth	20 $\frac{1}{4}$	No Arm Cap	22 $\frac{3}{8}$	Cubic Ft.	38.00
Height	29 $\frac{1}{2}$	Seat Width	25 $\frac{1}{2}$	Arm Cap	22 $\frac{1}{4}$		
				Arm Width	3 $\frac{1}{2}$		

- Contrasting fabric option – specify X (i.e., K89L2CVARIUTBX); see page 764. For list pricing, use your electronic specification tool or contact customer service
- Weight Limit 253 lbs.
- Tight-back
- Clean out
- 2mm tubular metal legs
- Non-skid, adjustable glides
- Arm caps on applicable models

TO ORDER, SPECIFY:

1. Model Number
2. Inner Back Upholstery Grade
3. Inner Back Upholstery Number
4. Outer Back Upholstery Grade
5. Outer Back Upholstery Number
6. Seat Upholstery Grade
7. Seat Upholstery Number
8. Arm Upholstery Grade
9. Arm Upholstery Number
10. Front Panel/Accent Upholstery Grade
11. Front Panel/Accent Upholstery Number
12. Leg Metal Finish Designator
13. Arm Cap Finish or Color Designator (if applicable)
14. Moisture Barrier Optional for Seat, or Seat and Inside Back

- See page 763 for Whittaker Health options
- See pages 797-802 for COM fabric yardage

WHITTAKER HEALTH

TWO SEAT INTERIOR ARM IN CENTER, CONVENIENCE ARM ON BOTH SIDES LOUNGE

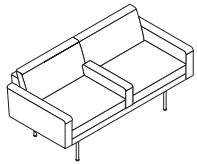

No Arm Caps

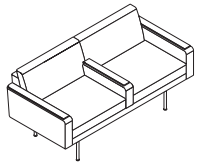

Arm Caps

MODEL NO.

ALLIANCE PROGRAM PRICE GRADES

			ALLIANCE PROGRAM PRICE GRADES									
			A	B	C	D	E	F	G	H	I	
			J	K	L	M	N	O	P	Q	R	
K89L2CVABIUTB	No Arm Caps	\$	5454	5731	5946	6169	6408	6686	6845	7147	7401	
			7664	8085	8920	9453	9572	9675	9801	9929	10519	
K89L2CVABIACWTB	Wood Arm Caps		5658	5935	6150	6373	6612	6890	7049	7351	7605	
			7868	8289	9124	9657	9776	9879	10005	10133	10723	
K89L2CVABIACPTB	Polyurethane Arm Caps		5908	6185	6400	6623	6862	7140	7299	7601	7855	
			8118	8539	9374	9907	10026	10129	10255	10383	10973	
K89L2CVABIACCTB	3D Laminate Arm Caps		6764	7041	7256	7479	7718	7996	8155	8457	8711	
			8974	9395	10230	10763	10882	10985	11111	11239	11829	
K89L2CVABIACSTB	Solid Surface Arm Caps		7101	7378	7593	7816	8055	8333	8492	8794	9048	
			9311	9732	10567	11100	11219	11322	11448	11576	12166	

DIMENSIONS

Width	62 $\frac{3}{8}$	Seat Height	18 $\frac{1}{2}$	Arm Height		Weight	140
Depth	29 $\frac{3}{4}$	Seat Depth	20 $\frac{1}{4}$	No Arm Cap	22 $\frac{3}{4}$	Cubic Ft.	38.00
Height	29 $\frac{3}{16}$	Seat Width	25 $\frac{1}{16}$	Arm Cap	22 $\frac{1}{4}$		
				Arm Width	3 $\frac{1}{2}$		

- Contrasting fabric option – specify X (i.e., K89L2CVABIUTBX); see page 764. For list pricing, use your electronic specification tool or contact customer service
- Weight Limit 253 lbs.
- Tight-back
- Clean out
- 2mm tubular metal legs
- Non-skid, adjustable glides
- Arm caps on applicable models

TO ORDER, SPECIFY:

- 1. Model Number
- 2. Inner Back Upholstery Grade
- 3. Inner Back Upholstery Number
- 4. Outer Back Upholstery Grade
- 5. Outer Back Upholstery Number
- 6. Seat Upholstery Grade
- 7. Seat Upholstery Number
- 8. Arm Upholstery Grade
- 9. Arm Upholstery Number
- 10. Front Panel/Accent Upholstery Grade
- 11. Front Panel/Accent Upholstery Number
- 12. Leg Metal Finish Designator
- 13. Arm Cap Finish or Color Designator (if applicable)
- 14. Moisture Barrier Optional for Seat, or Seat and Inside Back

- See page 763 for Whittaker Health options
- See pages 797-802 for COM fabric yardage

THREE SEAT INTERIOR ARM ON LEFT, CONVENIENCE ARM ON RIGHT LOUNGE

MODEL NO.

ALLIANCE PROGRAM PRICE GRADES

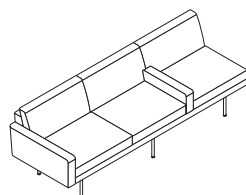

No Arm Caps

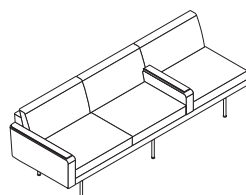

Arm Caps

		A	B	C	D	E	F	G	H	I
		J	K	L	M	N	O	P	Q	R
K89L3CVARILUTB	No Arm Caps	\$ 6778	7122	7388	7664	7960	8304	8501	8874	9190
		9514	10036	11069	11729	11875	12004	12161	12318	13046
K89L3CVARILACWTB	Wood Arm Caps	6865	7209	7475	7751	8047	8391	8588	8961	9277
		9601	10123	11156	11816	11962	12091	12248	12405	13133
K89L3CVARILACPTB	Polyurethane Arm Caps	6975	7319	7585	7861	8157	8501	8698	9071	9387
		9711	10233	11266	11926	12072	12201	12358	12515	13243
K89L3CVARILACTTB	3D Laminate Arm Caps	7669	8013	8279	8555	8851	9195	9392	9765	10081
		10405	10927	11960	12620	12766	12895	13052	13209	13937
K89L3CVARILACSTB	Solid Surface Arm Caps	7902	8246	8512	8788	9084	9428	9625	9998	10314
		10638	11160	12193	12853	12999	13128	13285	13442	14170

DIMENSIONS

Width	89½	Seat Height	18½	Arm Height		Weight	213
Depth	29¾	Seat Depth	20¾	No Arm Cap	22¾	Cubic Ft.	56.00
Height	29¾	Seat Width	25¾	Arm Cap	22¾		
				Arm Width	3½		

- Contrasting fabric option – specify X (i.e., K89L3CVARILUTBX); see page 764. For list pricing, use your electronic specification tool or contact customer service
- Weight Limit 253 lbs.
- Tight-back
- Clean out
- 2mm tubular metal legs
- Non-skid, adjustable glides
- Arm caps on applicable models

THREE SEAT INTERIOR ARM ON LEFT, CONVENIENCE ARMS ON BOTH SIDES LOUNGE

		A	B	C	D	E	F	G	H	I
		J	K	L	M	N	O	P	Q	R
K89L3CVABILUTB	No Arm Caps	\$ 7202	7559	7835	8122	8430	8788	8993	9381	9709
		10046	10589	11662	12349	12501	12635	12797	12961	13718
K89L3CVABILACWTB	Wood Arm Caps	7239	7596	7872	8159	8467	8825	9030	9418	9746
		10083	10626	11699	12386	12538	12672	12834	12998	13755
K89L3CVABILACPTB	Polyurethane Arm Caps	7450	7807	8083	8370	8678	9036	9241	9629	9957
		10294	10837	11910	12597	12749	12883	13045	13209	13966
K89L3CVABILACTTB	3D Laminate Arm Caps	8506	8863	9139	9426	9734	10092	10297	10685	11013
		11350	11893	12966	13653	13805	13939	14101	14265	15022
K89L3CVABILACSTB	Solid Surface Arm Caps	8851	9208	9484	9771	10079	10437	10642	11030	11358
		11695	12238	13311	13998	14150	14284	14446	14610	15367

DIMENSIONS

Width	89½	Seat Height	18½	Arm Height		Weight	221
Depth	29¾	Seat Depth	20¾	No Arm Cap	22¾	Cubic Ft.	58.00
Height	29¾	Seat Width	25¾	Arm Cap	22¾		
				Arm Width	3½		

- Contrasting fabric option – specify X (i.e., K89L3CVABILUTBX); see page 764. For list pricing, use your electronic specification tool or contact customer service
- Weight Limit 253 lbs.
- Tight-back
- Clean out
- 2mm tubular metal legs
- Non-skid, adjustable glides
- Arm caps on applicable models

WHITTAKER HEALTH

TO ORDER, SPECIFY:

1. Model Number
2. Inner Back Upholstery Grade
3. Inner Back Upholstery Number
4. Outer Back Upholstery Grade
5. Outer Back Upholstery Number
6. Seat Upholstery Grade
7. Seat Upholstery Number
8. Arm Upholstery Grade
9. Arm Upholstery Number
10. Front Panel/Accent Upholstery Grade
11. Front Panel/Accent Upholstery Number
12. Leg Metal Finish Designator
13. Arm Cap Finish or Color Designator (if applicable)
14. Moisture Barrier Optional for Seat, or Seat and Inside Back

- See page 763 for Whittaker Health options
- See pages 797-802 for COM fabric yardage

THREE SEAT INTERIOR ARM ON RIGHT, CONVENIENCE ARM ON LEFT LOUNGE

MODEL NO.

ALLIANCE PROGRAM PRICE GRADES

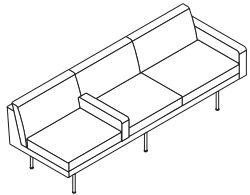

No Arm Caps

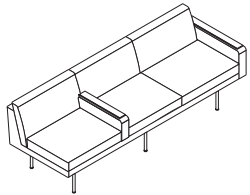

Arm Caps

			A	B	C	D	E	F	G	H	I
			J	K	L	M	N	O	P	Q	R
K89L3CVALIRUTB	No Arm Caps	\$	6778	7122	7388	7664	7960	8304	8501	8874	9190
			9514	10036	11069	11729	11875	12004	12161	12318	13046
K89L3CVALIRACWTB	Wood Arm Caps		6865	7209	7475	7751	8047	8391	8588	8961	9277
			9601	10123	11156	11816	11962	12091	12248	12405	13133
K89L3CVALIRACPTB	Polyurethane Arm Caps		6975	7319	7585	7861	8157	8501	8698	9071	9387
			9711	10233	11266	11926	12072	12201	12358	12515	13243
K89L3CVALIRACTTB	3D Laminate Arm Caps		7669	8013	8279	8555	8851	9195	9392	9765	10081
			10405	10927	11960	12620	12766	12895	13052	13209	13937
K89L3CVALIRACSTB	Solid Surface Arm Caps		7902	8246	8512	8788	9084	9428	9625	9998	10314
			10638	11160	12193	12853	12999	13128	13285	13442	14170

DIMENSIONS

Width	89 $\frac{1}{2}$	Seat Height	18 $\frac{1}{2}$	Arm Height		Weight	213
Depth	29 $\frac{3}{4}$	Seat Depth	20 $\frac{1}{4}$	No Arm Cap	22 $\frac{1}{4}$	Cubic Ft.	56.00
Height	29 $\frac{3}{8}$	Seat Width	25 $\frac{1}{4}$	Arm Cap	22 $\frac{1}{4}$		
				Arm Width	3 $\frac{1}{2}$		

- Contrasting fabric option – specify X (i.e., K89L3CVALIRUTBX); see page 764. For list pricing, use your electronic specification tool or contact customer service
- Weight Limit 253 lbs.
- Tight-back
- Clean out
- 2mm tubular metal legs
- Non-skid, adjustable glides
- Arm caps on applicable models

THREE SEAT INTERIOR ARM ON RIGHT, CONVENIENCE ARMS ON BOTH SIDES LOUNGE

			A	B	C	D	E	F	G	H	I
			J	K	L	M	N	O	P	Q	R
K89L3CVABIRUTB	No Arm Caps	\$	7202	7559	7835	8122	8430	8788	8993	9381	9709
			10046	10589	11662	12349	12501	12635	12797	12961	13718
K89L3CVABIRACWTB	Wood Arm Caps		7239	7596	7872	8159	8467	8825	9030	9418	9746
			10083	10626	11699	12386	12538	12672	12834	12998	13755
K89L3CVABIRACPTB	Polyurethane Arm Caps		7450	7807	8083	8370	8678	9036	9241	9629	9957
			10294	10837	11910	12597	12749	12883	13045	13209	13966
K89L3CVABIRACTTB	3D Laminate Arm Caps		8506	8863	9139	9426	9734	10092	10297	10685	11013
			11350	11893	12966	13653	13805	13939	14101	14265	15022
K89L3CVABIRACSTB	Solid Surface Arm Caps		8851	9208	9484	9771	10079	10437	10642	11030	11358
			11695	12238	13311	13998	14150	14284	14446	14610	15367

DIMENSIONS

Width	89 $\frac{1}{2}$	Seat Height	18 $\frac{1}{2}$	Arm Height		Weight	221
Depth	29 $\frac{3}{4}$	Seat Depth	20 $\frac{1}{4}$	No Arm Cap	22 $\frac{1}{4}$	Cubic Ft.	58.00
Height	29 $\frac{3}{8}$	Seat Width	25 $\frac{1}{4}$	Arm Cap	22 $\frac{1}{4}$		
				Arm Width	3 $\frac{1}{2}$		

- Contrasting fabric option – specify X (i.e., K89L3CVABIRUTBX); see page 764. For list pricing, use your electronic specification tool or contact customer service
- Weight Limit 253 lbs.
- Tight-back
- Clean out
- 2mm tubular metal legs
- Non-skid, adjustable glides
- Arm caps on applicable models

TO ORDER, SPECIFY:

- 1. Model Number
- 2. Inner Back Upholstery Grade
- 3. Inner Back Upholstery Number
- 4. Outer Back Upholstery Grade
- 5. Outer Back Upholstery Number
- 6. Seat Upholstery Grade
- 7. Seat Upholstery Number
- 8. Arm Upholstery Grade
- 9. Arm Upholstery Number
- 10. Front Panel/Accent Upholstery Grade
- 11. Front Panel/Accent Upholstery Number
- 12. Leg Metal Finish Designator
- 13. Arm Cap Finish or Color Designator (if applicable)
- 14. Moisture Barrier Optional for Seat, or Seat and Inside Back

- See page 763 for Whittaker Health options
- See pages 797-802 for COM fabric yardage

**THREE SEAT INTERIOR
ARMS ON LEFT AND RIGHT,
CONVENIENCE ARM ON
RIGHT LOUNGE**

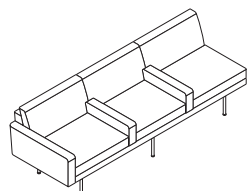

No Arm Caps

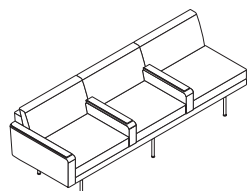

Arm Caps

**MODEL
NO.**

ALLIANCE PROGRAM PRICE GRADES

		A	B	C	D	E	F	G	H	I
		J	K	L	M	N	O	P	Q	R
K89L3CVARIBUTB	No Arm Caps	\$ 7120	7487	7770	8064	8380	8747	8958	9356	9693
		10039	10596	11697	12402	12559	12696	12863	13031	13807
K89L3CVARIBACWTB	Wood Arm Caps	7225	7592	7875	8169	8485	8852	9063	9461	9798
		10144	10701	11802	12507	12664	12801	12968	13136	13912
K89L3CVARIBACPTB	Polyurethane Arm Caps	7374	7741	8024	8318	8634	9001	9212	9610	9947
		10293	10850	11951	12656	12813	12950	13117	13285	14061
K89L3CVARIBACTTB	3D Laminate Arm Caps	8396	8763	9046	9340	9656	10023	10234	10632	10969
		11315	11872	12973	13678	13835	13972	14139	14307	15083
K89L3CVARIBACSTB	Solid Surface Arm Caps	8752	9119	9402	9696	10012	10379	10590	10988	11325
		11671	12228	13329	14034	14191	14328	14495	14663	15439

DIMENSIONS

Width	89½	Seat Height	18½	Arm Height		Weight	221
Depth	29¾	Seat Depth	20¾	No Arm Cap	22¾	Cubic Ft.	58.00
Height	29¾	Seat Width	25¾	Arm Cap	22¾		
				Arm Width	3½		

- Contrasting fabric option – specify X (i.e., K89L3CVARIBUTBX); see page 764. For list pricing, use your electronic specification tool or contact customer service
- Weight Limit 253 lbs.
- Tight-back
- Clean out
- 2mm tubular metal legs
- Non-skid, adjustable glides
- Arm caps on applicable models

**THREE SEAT INTERIOR
ARMS ON LEFT AND RIGHT,
CONVENIENCE ARM ON
LEFT LOUNGE**

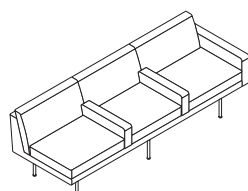

No Arm Caps

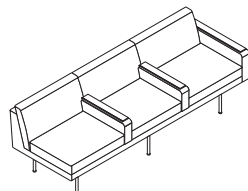

Arm Caps

		A	B	C	D	E	F	G	H	I
		J	K	L	M	N	O	P	Q	R
K89L3CVALIBUTB	No Arm Caps	\$ 7120	7487	7770	8064	8380	8747	8958	9356	9693
		10039	10596	11697	12402	12559	12696	12863	13031	13807
K89L3CVALIBACWTB	Wood Arm Caps	7225	7592	7875	8169	8485	8852	9063	9461	9798
		10144	10701	11802	12507	12664	12801	12968	13136	13912
K89L3CVALIBACPTB	Polyurethane Arm Caps	7374	7741	8024	8318	8634	9001	9212	9610	9947
		10293	10850	11951	12656	12813	12950	13117	13285	14061
K89L3CVALIBACTTB	3D Laminate Arm Caps	8396	8763	9046	9340	9656	10023	10234	10632	10969
		11315	11872	12973	13678	13835	13972	14139	14307	15083
K89L3CVALIBACSTB	Solid Surface Arm Caps	8752	9119	9402	9696	10012	10379	10590	10988	11325
		11671	12228	13329	14034	14191	14328	14495	14663	15439

DIMENSIONS

Width	89½	Seat Height	18½	Arm Height		Weight	220
Depth	29¾	Seat Depth	20¾	No Arm Cap	22¾	Cubic Ft.	56.00
Height	29¾	Seat Width	25¾	Arm Cap	22¾		
				Arm Width	3½		

- Contrasting fabric option – specify X (i.e., K89L3CVALIBUTBX); see page 764. For list pricing, use your electronic specification tool or contact customer service
- Weight Limit 253 lbs.
- Tight-back
- Clean out
- 2mm tubular metal legs
- Non-skid, adjustable glides
- Arm caps on applicable models

TO ORDER, SPECIFY:

1. Model Number
2. Inner Back Upholstery Grade
3. Inner Back Upholstery Number
4. Outer Back Upholstery Grade
5. Outer Back Upholstery Number
6. Seat Upholstery Grade
7. Seat Upholstery Number
8. Arm Upholstery Grade
9. Arm Upholstery Number
10. Front Panel/Accent Upholstery Grade
11. Front Panel/Accent Upholstery Number
12. Leg Metal Finish Designator
13. Arm Cap Finish or Color Designator (if applicable)
14. Moisture Barrier Optional for Seat, or Seat and Inside Back

- See page 763 for Whittaker Health options
- See pages 797-802 for COM fabric yardage

WHITTAKER HEALTH

**THREE SEAT INTERIOR
ARMS ON LEFT AND RIGHT,
CONVENIENCE ARMS ON
BOTH SIDES LOUNGE**

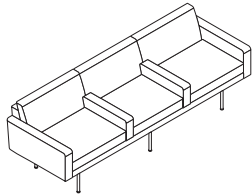

No Arm Caps

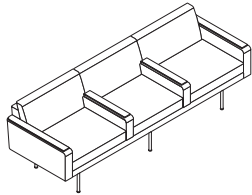

Arm Caps

**MODEL
NO.**

ALLIANCE PROGRAM PRICE GRADES

			A	B	C	D	E	F	G	H	I
			J	K	L	M	N	O	P	Q	R
			K89L3CVABIBUTB	No Arm Caps	\$ 7525	7892	8175	8469	8785	9152	9363
			10444	11001	12102	12807	12964	13101	13268	13436	14212
K89L3CVABIBACWTB	Wood Arm Caps	7536	7903	8186	8480	8796	9163	9374	9772	10109	
			10455	11012	12113	12818	12975	13112	13279	13447	14223
K89L3CVABIBACPTB	Polyurethane Arm Caps	7849	8216	8499	8793	9109	9476	9687	10085	10422	
			10768	11325	12426	13131	13288	13425	13592	13760	14536
K89L3CVABIBACTTB	3D Laminate Arm Caps	9232	9599	9882	10176	10492	10859	11070	11468	11805	
			12151	12708	13809	14514	14671	14808	14975	15143	15919
K89L3CVABIBACSTB	Solid Surface Arm Caps	9669	10036	10319	10613	10929	11296	11507	11905	12242	
			12588	13145	14246	14951	15108	15245	15412	15580	16356

DIMENSIONS

Width	89½	Seat Height	18½	Arm Height		Weight	228
Depth	29¾	Seat Depth	20¼	No Arm Cap	22¾	Cubic Ft.	58.00
Height	29¾	Seat Width	25¼	Arm Cap	22¼		
				Arm Width	3½		

- Contrasting fabric option – specify X (i.e., K89L3CVABIBUTBX); see page 764. For list pricing, use your electronic specification tool or contact customer service
- Weight Limit 253 lbs.
- Tight-back
- Clean out
- 2mm tubular metal legs
- Non-skid, adjustable glides
- Arm caps on applicable models

TO ORDER, SPECIFY:

1. Model Number
2. Inner Back Upholstery Grade
3. Inner Back Upholstery Number
4. Outer Back Upholstery Grade
5. Outer Back Upholstery Number
6. Seat Upholstery Grade
7. Seat Upholstery Number
8. Front Panel/Accent Upholstery Grade
9. Front Panel/Accent Upholstery Number
10. Leg Metal Finish Designator
11. Moisture Barrier Optional for Seat, or Seat and Inside Back

- See page 763 for Whittaker Health options
- See pages 797-802 for COM fabric yardage

ARMLESS LEFT CORNER LOUNGE

MODEL NO.

ALLIANCE PROGRAM PRICE GRADES

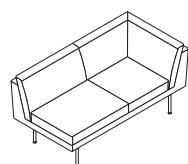

Two Seat

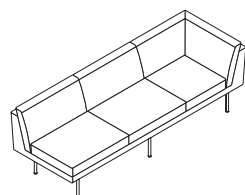

Three Seat

			A	B	C	D	E	F	G	H	I
			J	K	L	M	N	O	P	Q	R
K89C2LXATB	Two Seat	\$	4925	5179	5376	5580	5799	6053	6198	6475	6708
			6949	7334	8099	8586	8696	8790	8906	9023	9562
K89C3LXATB	Three Seat		6590	6924	7182	7451	7737	8072	8263	8627	8932
			9248	9753	10758	11399	11542	11665	11819	11972	12680

DIMENSIONS - TWO SEAT

Width	57 ¹ / ₁₆	Seat Height	18 ¹ / ₂	Weight	135
Depth	29 ³ / ₄	Seat Depth	20 ¹ / ₁₆	Cubic Ft.	37.00
Height	29 ¹³ / ₁₆	Seat Width	47 ³ / ₁₆		

DIMENSIONS - THREE SEAT

Width	84 ¹ / ₂	Seat Height	18 ¹ / ₂	Weight	182
Depth	29 ³ / ₄	Seat Depth	20 ¹ / ₁₆	Cubic Ft.	55.00
Height	29 ¹³ / ₁₆	Seat Width	74 ³ / ₄		

- Contrasting fabric option – specify X (i.e., K89C2LXATBX); see page 764. For list pricing, use your electronic specification tool or contact customer service
- Weight Limit 253 lbs.
- Tight-back
- Clean out
- 2mm tubular metal legs
- Non-skid, adjustable glides

WHITTAKER HEALTH

WHITTAKER HEALTH

TO ORDER, SPECIFY:

1. Model Number
2. Inner Back Upholstery Grade
3. Inner Back Upholstery Number
4. Outer Back Upholstery Grade
5. Outer Back Upholstery Number
6. Seat Upholstery Grade
7. Seat Upholstery Number
8. Arm Upholstery Grade
9. Arm Upholstery Number
10. Front Panel/Accent Upholstery Grade
11. Front Panel/Accent Upholstery Number
12. Leg Metal Finish Designator
13. Arm Cap Finish or Color Designator (if applicable)
14. Moisture Barrier Optional for Seat, or Seat and Inside Back

- See page 763 for Whittaker Health options
- See pages 797-802 for COM fabric yardage

TWO SEAT LEFT CORNER CONVENIENCE ARM ON RIGHT LOUNGE

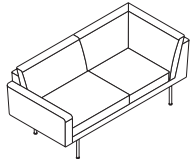

No Arm Cap

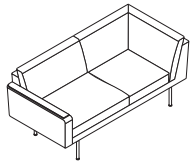

Arm Cap

MODEL NO.

ALLIANCE PROGRAM PRICE GRADES

			A	B	C	D	E	F	G	H	I
			J	K	L	M	N	O	P	Q	R
K89C2LCVAUTB	No Arm Cap	\$	5498	5797	6029	6269	6526	6825	6995	7321	7595
			7878	8331	9231	9803	9932	10043	10180	10317	10951
K89C2LCVAACWTB	Wood Arm Cap		5555	5854	6086	6326	6583	6882	7052	7378	7652
			7935	8388	9288	9860	9989	10100	10237	10374	11008
K89C2LCVAACPTB	Polyurethane Arm Cap		5587	5886	6118	6358	6615	6914	7084	7410	7684
			7967	8420	9320	9892	10021	10132	10269	10406	11040
K89C2LCVAACCTB	3D Laminate Arm Cap		5714	6013	6245	6485	6742	7041	7211	7537	7811
			8094	8547	9447	10019	10148	10259	10396	10533	11167
K89C2LCVAACSTB	Solid Surface Arm Cap		5940	6239	6471	6711	6968	7267	7437	7763	8037
			8320	8773	9673	10245	10374	10485	10622	10759	11393

DIMENSIONS

Width	62 $\frac{1}{2}$	Seat Height	18 $\frac{1}{2}$	Arm Height		Weight	142
Depth	29 $\frac{3}{4}$	Seat Depth	20 $\frac{1}{4}$	No Arm Cap	22 $\frac{1}{4}$	Cubic Ft.	40.00
Height	29 $\frac{3}{16}$	Seat Width	25 $\frac{1}{16}$	Arm Cap	22 $\frac{1}{16}$		
				Arm Width	3 $\frac{1}{2}$		

- Contrasting fabric option – specify X (i.e., K89C2LCVAUTBX); see page 764. For list pricing, use your electronic specification tool or contact customer service
- Weight Limit 253 lbs.
- Tight-back
- Clean out
- 2mm tubular metal legs
- Non-skid, adjustable glides
- Arm caps on applicable models

THREE SEAT LEFT CORNER CONVENIENCE ARM ON RIGHT LOUNGE

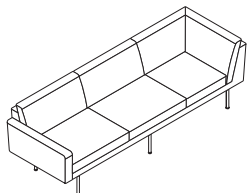

No Arm Cap

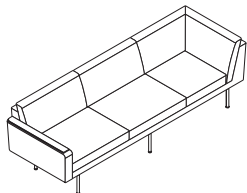

Arm Cap

			A	B	C	D	E	F	G	H	I
			J	K	L	M	N	O	P	Q	R
K89C3LCVAUTB	No Arm Cap	\$	7160	7539	7832	8137	8461	8841	9057	9470	9816
			10174	10747	11887	12613	12775	12915	13090	13263	14066
K89C3LCVAACWTB	Wood Arm Cap		7216	7595	7888	8193	8517	8897	9113	9526	9872
			10230	10803	11943	12669	12831	12971	13146	13319	14122
K89C3LCVAACPTB	Polyurethane Arm Cap		7249	7628	7921	8226	8550	8930	9146	9559	9905
			10263	10836	11976	12702	12864	13004	13179	13352	14155
K89C3LCVAACCTB	3D Laminate Arm Cap		7377	7756	8049	8354	8678	9058	9274	9687	10033
			10391	10964	12104	12830	12992	13132	13307	13480	14283
K89C3LCVAACSTB	Solid Surface Arm Cap		7602	7981	8274	8579	8903	9283	9499	9912	10258
			10616	11189	12329	13055	13217	13357	13532	13705	14508

DIMENSIONS

Width	88	Seat Height	18 $\frac{1}{2}$	Arm Height		Weight	190
Depth	29 $\frac{3}{4}$	Seat Depth	20 $\frac{1}{4}$	No Arm Cap	22 $\frac{1}{4}$	Cubic Ft.	57.00
Height	29 $\frac{3}{16}$	Seat Width	74 $\frac{1}{4}$	Arm Cap	22 $\frac{1}{16}$		
				Arm Width	3 $\frac{1}{2}$		

- Contrasting fabric option – specify X (i.e., K89C3LCVAUTBX); see page 764. For list pricing, use your electronic specification tool or contact customer service
- Weight Limit 253 lbs.
- Tight-back
- Clean out
- 2mm tubular metal legs
- Non-skid, adjustable glides
- Arm caps on applicable models

TO ORDER, SPECIFY:

1. Model Number
2. Inner Back Upholstery Grade
3. Inner Back Upholstery Number
4. Outer Back Upholstery Grade
5. Outer Back Upholstery Number
6. Seat Upholstery Grade
7. Seat Upholstery Number
8. Arm Upholstery Grade
9. Arm Upholstery Number
10. Front Panel/Accent Upholstery Grade
11. Front Panel/Accent Upholstery Number
12. Leg Metal Finish Designator
13. Moisture Barrier Optional for Seat, or Seat and Inside Back

- See page 763 for Whittaker Health options
- See pages 797-802 for COM fabric yardage

**FULL ARM ON RIGHT
LEFT CORNER LOUNGE**

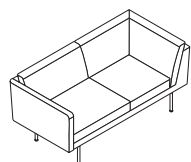

Two Seat

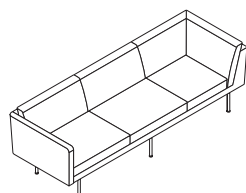

Three Seat

**MODEL
NO.**

ALLIANCE PROGRAM PRICE GRADES

		A	B	C	D	E	F	G	H	I
		J	K	L	M	N	O	P	Q	R
K89C2LFATB	Two Seat	\$ 5504	5807	6043	6286	6548	6852	7025	7356	7635
		7922	8383	9297	9879	10010	10123	10261	10401	11045
K89C3LFATB	Three Seat	7167	7550	7847	8155	8484	8869	9088	9506	9857
		10219	10800	11954	12690	12854	12996	13172	13348	14161

DIMENSIONS - TWO SEAT

Width	59½	Seat Height	18½	Arm Height	26½	Weight	142
Depth	29¾	Seat Depth	20½	Arm Width	2	Cubic Ft.	39.00
Height	29⅜	Seat Width	47½				

DIMENSIONS - THREE SEAT

Width	86½	Seat Height	18½	Arm Height	26½	Weight	190
Depth	29¾	Seat Depth	20½	Arm Width	2	Cubic Ft.	56.00
Height	29⅜	Seat Width	74¾				

- Contrasting fabric option – specify X (i.e., K89C2LFATBX); see page 764. For list pricing, use your electronic specification tool or contact customer service
- Weight Limit 253 lbs.
- Tight-back
- Clean out
- 2mm tubular metal legs
- Non-skid, adjustable glides

**THREE SEAT LEFT CORNER,
INTERIOR ARM ON RIGHT
LOUNGE**

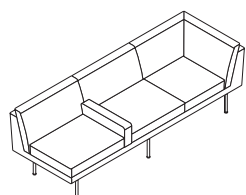

		A	B	C	D	E	F	G	H	I
		J	K	L	M	N	O	P	Q	R
K89C3LXAIRTB	Three Seat	\$ 6452	6829	7120	7423	7745	8123	8339	8749	9093
		9449	10019	11152	11875	12036	12175	12348	12521	13319

DIMENSIONS

Width	84½	Seat Height	18½	Arm Height	22½	Weight	189
Depth	29¾	Seat Depth	20½	Arm Width	3½	Cubic Ft.	55.00
Height	29⅜	Seat Width	25⅜				

- Contrasting fabric option – specify X (i.e., K89C3LXAIRTBX); see page 764. For list pricing, use your electronic specification tool or contact customer service
- Weight Limit 253 lbs.
- Tight-back
- Clean out
- 2mm tubular metal legs
- Non-skid, adjustable glides

WHITTAKER HEALTH

TO ORDER, SPECIFY:

1. Model Number
2. Inner Back Upholstery Grade
3. Inner Back Upholstery Number
4. Outer Back Upholstery Grade
5. Outer Back Upholstery Number
6. Seat Upholstery Grade
7. Seat Upholstery Number
8. Arm Upholstery Grade
9. Arm Upholstery Number
10. Front Panel/Accent Upholstery Grade
11. Front Panel/Accent Upholstery Number
12. Leg Metal Finish Designator
13. Arm Cap Finish or Color Designator (if applicable)
14. Moisture Barrier Optional for Seat, or Seat and Inside Back

- See page 763 for Whittaker Health options
- See pages 797-802 for COM fabric yardage

WHITTAKER HEALTH

THREE SEAT LEFT CORNER, INTERIOR ARM ON RIGHT, CONVENIENCE ARM ON RIGHT LOUNGE

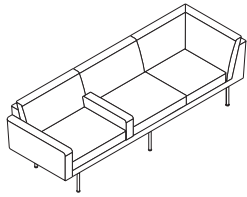

No Arm Caps

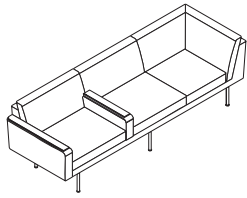

Arm Caps

MODEL NO.

ALLIANCE PROGRAM PRICE GRADES

			A	B	C	D	E	F	G	H	I
			J	K	L	M	N	O	P	Q	R
K89C3LCVAUIRTB	No Arm Caps	\$	7140	7519	7812	8117	8441	8821	9037	9450	9796
			10154	10727	11867	12593	12755	12895	13070	13243	14046
K89C3LCVAACWIRTB	Wood Arm Caps		7215	7594	7887	8192	8516	8896	9112	9525	9871
			10229	10802	11942	12668	12830	12970	13145	13318	14121
K89C3LCVAACPIRTB	Polyurethane Arm Caps		7320	7699	7992	8297	8621	9001	9217	9630	9976
			10334	10907	12047	12773	12935	13075	13250	13423	14226
K89C3LCVAACTIRTB	3D Laminate Arm Caps		7529	7908	8201	8506	8830	9210	9426	9839	10185
			10543	11116	12256	12982	13144	13284	13459	13632	14435
K89C3LCVAACSIRTB	Solid Surface Arm Caps		8021	8400	8693	8998	9322	9702	9918	10331	10677
			11035	11608	12748	13474	13636	13776	13951	14124	14927

DIMENSIONS

Width	88	Seat Height	18 $\frac{1}{2}$	Arm Height		Weight	197
Depth	29 $\frac{3}{4}$	Seat Depth	20 $\frac{1}{4}$	No Arm Cap	22 $\frac{3}{4}$	Cubic Ft.	57.00
Height	29 $\frac{3}{16}$	Seat Width	25 $\frac{1}{16}$	Arm Cap	22 $\frac{1}{16}$		
				Arm Width	3 $\frac{1}{2}$		

- Contrasting fabric option – specify X (i.e., K89C3LCVAUIRTBX); see page 764. For list pricing, use your electronic specification tool or contact customer service
- Weight Limit 253 lbs.
- Tight-back
- Clean out
- 2mm tubular metal legs
- Non-skid, adjustable glides
- Arm caps on applicable models

TO ORDER, SPECIFY:

1. Model Number
2. Inner Back Upholstery Grade
3. Inner Back Upholstery Number
4. Outer Back Upholstery Grade
5. Outer Back Upholstery Number
6. Seat Upholstery Grade
7. Seat Upholstery Number
8. Front Panel/Accent Upholstery Grade
9. Front Panel/Accent Upholstery Number
10. Leg Metal Finish Designator
11. Moisture Barrier Optional for Seat, or Seat and Inside Back

- See page 763 for Whittaker Health options
- See pages 797-802 for COM fabric yardage

ARMLESS RIGHT CORNER LOUNGE

MODEL NO.

ALLIANCE PROGRAM PRICE GRADES

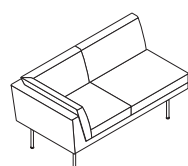

Two Seat

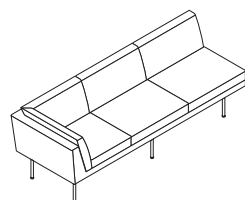

Three Seat

			A	B	C	D	E	F	G	H	I
			J	K	L	M	N	O	P	Q	R
K89C2RXATB	Two Seat	\$	4925	5179	5376	5580	5799	6053	6198	6475	6708
			6949	7334	8099	8586	8696	8790	8906	9023	9562
K89C3RXATB	Three Seat		6590	6924	7182	7451	7737	8072	8263	8627	8932
			9248	9753	10758	11399	11542	11665	11819	11972	12680

DIMENSIONS - TWO SEAT

Width	57 ¹ / ₁₆	Seat Height	18 ¹ / ₂	Weight	135
Depth	29 ³ / ₄	Seat Depth	20 ¹ / ₁₆	Cubic Ft.	37.00
Height	29 ¹³ / ₁₆	Seat Width	47 ³ / ₁₆		

DIMENSIONS - THREE SEAT

Width	84 ¹ / ₂	Seat Height	18 ¹ / ₂	Weight	182
Depth	29 ³ / ₄	Seat Depth	20 ¹ / ₁₆	Cubic Ft.	55.00
Height	29 ¹³ / ₁₆	Seat Width	74 ³ / ₄		

- Contrasting fabric option – specify X (i.e., K89C2RXATBX); see page 764. For list pricing, use your electronic specification tool or contact customer service
- Weight Limit 253 lbs.
- Tight-back
- Clean out
- 2mm tubular metal legs
- Non-skid, adjustable glides

WHITTAKER HEALTH

TO ORDER, SPECIFY:

1. Model Number
2. Inner Back Upholstery Grade
3. Inner Back Upholstery Number
4. Outer Back Upholstery Grade
5. Outer Back Upholstery Number
6. Seat Upholstery Grade
7. Seat Upholstery Number
8. Arm Upholstery Grade
9. Arm Upholstery Number
10. Front Panel/Accent Upholstery Grade
11. Front Panel/Accent Upholstery Number
12. Leg Metal Finish Designator
13. Arm Cap Finish or Color Designator (if applicable)
14. Moisture Barrier Optional for Seat, or Seat and Inside Back

- See page 763 for Whittaker Health options
- See pages 797-802 for COM fabric yardage

TWO SEAT RIGHT CORNER CONVENIENCE ARM ON LEFT LOUNGE

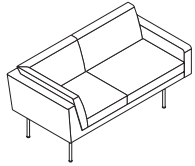

No Arm Cap

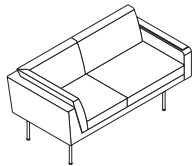

Arm Cap

MODEL NO.

ALLIANCE PROGRAM PRICE GRADES

			A	B	C	D	E	F	G	H	I
			J	K	L	M	N	O	P	Q	R
K89C2RCVAUTB	No Arm Cap	\$	5498	5797	6029	6269	6526	6825	6995	7321	7595
			7878	8331	9231	9803	9932	10043	10180	10317	10951
K89C2RCVAACWTB	Wood Arm Cap		5555	5854	6086	6326	6583	6882	7052	7378	7652
			7935	8388	9288	9860	9989	10100	10237	10374	11008
K89C2RCVAACPTB	Polyurethane Arm Cap		5587	5886	6118	6358	6615	6914	7084	7410	7684
			7967	8420	9320	9892	10021	10132	10269	10406	11040
K89C2RCVAACCTB	3D Laminate Arm Cap		5714	6013	6245	6485	6742	7041	7211	7537	7811
			8094	8547	9447	10019	10148	10259	10396	10533	11167
K89C2RCVAACSTB	Solid Surface Arm Cap		5940	6239	6471	6711	6968	7267	7437	7763	8037
			8320	8773	9673	10245	10374	10485	10622	10759	11393

DIMENSIONS

Width	62 $\frac{1}{2}$	Seat Height	18 $\frac{1}{2}$	Arm Height		Weight	142
Depth	29 $\frac{3}{4}$	Seat Depth	20 $\frac{1}{4}$	No Arm Cap	22 $\frac{1}{4}$	Cubic Ft.	40.00
Height	29 $\frac{3}{8}$	Seat Width	47 $\frac{1}{4}$	Arm Cap	22 $\frac{1}{4}$		
				Arm Width	3 $\frac{1}{2}$		

- Contrasting fabric option – specify X (i.e., K89C2RCVAUTBX); see page 764. For list pricing, use your electronic specification tool or contact customer service
- Weight Limit 253 lbs.
- Tight-back
- Clean out
- 2mm tubular metal legs
- Non-skid, adjustable glides
- Arm caps on applicable models

THREE SEAT RIGHT CORNER CONVENIENCE ARM ON LEFT LOUNGE

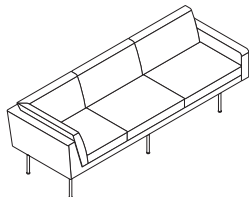

No Arm Cap

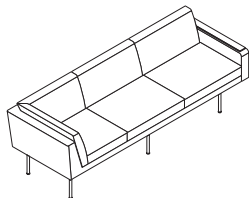

Arm Cap

			A	B	C	D	E	F	G	H	I
			J	K	L	M	N	O	P	Q	R
K89C3RCVAUTB	No Arm Cap	\$	7160	7539	7832	8137	8461	8841	9057	9470	9816
			10174	10747	11887	12613	12775	12915	13090	13263	14066
K89C3RCVAACWTB	Wood Arm Cap		7216	7595	7888	8193	8517	8897	9113	9526	9872
			10230	10803	11943	12669	12831	12971	13146	13319	14122
K89C3RCVAACPTB	Polyurethane Arm Cap		7249	7628	7921	8226	8550	8930	9146	9559	9905
			10263	10836	11976	12702	12864	13004	13179	13352	14155
K89C3RCVAACCTB	3D Laminate Arm Cap		7377	7756	8049	8354	8678	9058	9274	9687	10033
			10391	10964	12104	12830	12992	13132	13307	13480	14283
K89C3RCVAACSTB	Solid Surface Arm Cap		7602	7981	8274	8579	8903	9283	9499	9912	10258
			10616	11189	12329	13055	13217	13357	13532	13705	14508

DIMENSIONS

Width	88	Seat Height	18 $\frac{1}{2}$	Arm Height		Weight	190
Depth	29 $\frac{3}{4}$	Seat Depth	20 $\frac{1}{4}$	No Arm Cap	22 $\frac{1}{4}$	Cubic Ft.	57.00
Height	29 $\frac{3}{8}$	Seat Width	74 $\frac{1}{4}$	Arm Cap	22 $\frac{1}{4}$		
				Arm Width	3 $\frac{1}{2}$		

- Contrasting fabric option – specify X (i.e., K89C3RCVAUTBX); see page 764. For list pricing, use your electronic specification tool or contact customer service
- Weight Limit 253 lbs.
- Tight-back
- Clean out
- 2mm tubular metal legs
- Non-skid, adjustable glides
- Arm caps on applicable models

TO ORDER, SPECIFY:

1. Model Number
2. Inner Back Upholstery Grade
3. Inner Back Upholstery Number
4. Outer Back Upholstery Grade
5. Outer Back Upholstery Number
6. Seat Upholstery Grade
7. Seat Upholstery Number
8. Arm Upholstery Grade
9. Arm Upholstery Number
10. Front Panel/Accent Upholstery Grade
11. Front Panel/Accent Upholstery Number
12. Leg Metal Finish Designator
13. Moisture Barrier Optional for Seat, or Seat and Inside Back

- See page 763 for Whittaker Health options
- See pages 797-802 for COM fabric yardage

**FULL ARM ON LEFT RIGHT
CORNER LOUNGE**

**MODEL
NO.**

ALLIANCE PROGRAM PRICE GRADES

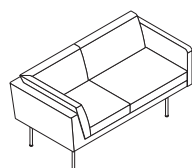

Two Seat

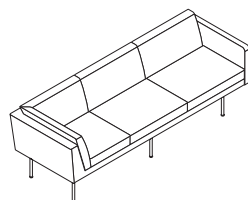

Three Seat

			A	B	C	D	E	F	G	H	I
			J	K	L	M	N	O	P	Q	R
K89C2RFATB	Two Seat	\$	5504	5807	6043	6286	6548	6852	7025	7356	7635
			7922	8383	9297	9879	10010	10123	10261	10401	11045
K89C3RFATB	Three Seat		7167	7550	7847	8155	8484	8869	9088	9506	9857
			10219	10800	11954	12690	12854	12996	13172	13348	14161

DIMENSIONS - TWO SEAT

Width	59½	Seat Height	18½	Arm Height	26½	Weight	142
Depth	29¾	Seat Depth	20½	Arm Width	2	Cubic Ft.	39.00
Height	29⅞	Seat Width	47½				

DIMENSIONS - THREE SEAT

Width	86½	Seat Height	18½	Arm Height	26½	Weight	190
Depth	29¾	Seat Depth	20½	Arm Width	2	Cubic Ft.	56.00
Height	29⅞	Seat Width	74¾				

- Contrasting fabric option – specify X (i.e., K89C2RFATBX); see page 764. For list pricing, use your electronic specification tool or contact customer service
- Weight Limit 253 lbs.
- Tight-back
- Clean out
- 2mm tubular metal legs
- Non-skid, adjustable glides

WHITTAKER HEALTH

TO ORDER, SPECIFY:

1. Model Number
2. Inner Back Upholstery Grade
3. Inner Back Upholstery Number
4. Outer Back Upholstery Grade
5. Outer Back Upholstery Number
6. Seat Upholstery Grade
7. Seat Upholstery Number
8. Arm Upholstery Grade
9. Arm Upholstery Number
10. Front Panel/Accent Upholstery Grade
11. Front Panel/Accent Upholstery Number
12. Leg Metal Finish Designator
13. Moisture Barrier Optional for Seat, or Seat and Inside Back

- See page 763 for Whittaker Health options
- See pages 797-802 for COM fabric yardage

THREE SEAT RIGHT CORNER, INTERIOR ARM ON LEFT LOUNGE

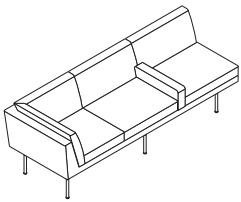

MODEL NO.

ALLIANCE PROGRAM PRICE GRADES

		A	B	C	D	E	F	G	H	I
		J	K	L	M	N	O	P	Q	R
K89C3RXAILTB	Three Seat	\$ 6452	6829	7120	7423	7745	8123	8339	8749	9093
		9449	10019	11152	11875	12036	12175	12348	12521	13319

DIMENSIONS

Width	84½	Seat Height	18¾	Arm Height	22¾	Weight	189
Depth	29¾	Seat Depth	20¾	Arm Width	3½	Cubic Ft.	55.00
Height	29¾	Seat Width	25¾				

- Contrasting fabric option – specify X (i.e., K89C3RXAILTBX); see page 764. For list pricing, use your electronic specification tool or contact customer service
- Weight Limit 253 lbs.
- Tight-back
- Clean out
- 2mm tubular metal legs
- Non-skid, adjustable glides

TO ORDER, SPECIFY:

1. Model Number
2. Inner Back Upholstery Grade
3. Inner Back Upholstery Number
4. Outer Back Upholstery Grade
5. Outer Back Upholstery Number
6. Seat Upholstery Grade
7. Seat Upholstery Number
8. Arm Upholstery Grade
9. Arm Upholstery Number
10. Front Panel/Accent Upholstery Grade
11. Front Panel/Accent Upholstery Number
12. Leg Metal Finish Designator
13. Arm Cap Finish or Color Designator (if applicable)
14. Moisture Barrier Optional for Seat, or Seat and Inside Back

- See page 763 for Whittaker Health options
- See pages 797-802 for COM fabric yardage

THREE SEAT RIGHT CORNER, INTERIOR ARM ON LEFT, CONVENIENCE ARM ON LEFT LOUNGE

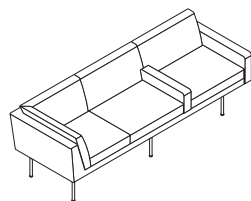

No Arm Caps

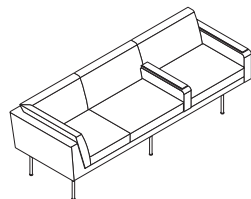

Arm Caps

MODEL NO.

ALLIANCE PROGRAM PRICE GRADES

			A	B	C	D	E	F	G	H	I
			J	K	L	M	N	O	P	Q	R
K89C3RCVAUULTB	No Arm Caps	\$	7140	7519	7812	8117	8441	8821	9037	9450	9796
			10154	10727	11867	12593	12755	12895	13070	13243	14046
K89C3RCVAACWILTB	Wood Arm Caps		7215	7594	7887	8192	8516	8896	9112	9525	9871
			10229	10802	11942	12668	12830	12970	13145	13318	14121
K89C3RCVAACPILTB	Polyurethane Arm Caps		7320	7699	7992	8297	8621	9001	9217	9630	9976
			10334	10907	12047	12773	12935	13075	13250	13423	14226
K89C3RCVAACTILTB	3D Laminate Arm Caps		7529	7908	8201	8506	8830	9210	9426	9839	10185
			10543	11116	12256	12982	13144	13284	13459	13632	14435
K89C3RCVAACSILTB	Solid Surface Arm Caps		8021	8400	8693	8998	9322	9702	9918	10331	10677
			11035	11608	12748	13474	13636	13776	13951	14124	14927

DIMENSIONS

Width	88	Seat Height	18 ¹ / ₂	Arm Height		Weight	197
Depth	29 ³ / ₄	Seat Depth	20 ¹ / ₄	No Arm Cap	22 ³ / ₄	Cubic Ft.	57.00
Height	29 ³ / ₁₆	Seat Width	25 ¹ / ₁₆	Arm Cap	22 ¹ / ₄		
				Arm Width	3 ¹ / ₂		

- Contrasting fabric option – specify X (i.e., K89C3RCVAUULTBX); see page 764. For list pricing, use your electronic specification tool or contact customer service
- Weight Limit 253 lbs.
- Tight-back
- Clean out
- 2mm tubular metal legs
- Non-skid, adjustable glides
- Arm caps on applicable models

WHITTAKER HEALTH

TO ORDER, SPECIFY:

1. Model Number
2. Inner Back Upholstery Grade
3. Inner Back Upholstery Number
4. Outer Back Upholstery Grade
5. Outer Back Upholstery Number
6. Seat Upholstery Grade
7. Seat Upholstery Number
8. Front Panel/Accent Upholstery Grade
9. Front Panel/Accent Upholstery Number
10. Leg Metal Finish Designator
11. Moisture Barrier Optional for Seat, or Seat and Inside Back

- See page 763 for Whittaker Health options
- See pages 797-802 for COM fabric yardage

TWO SEAT ARMLESS, PENINSULA LOUNGE

MODEL NO.

ALLIANCE PROGRAM PRICE GRADES

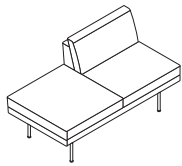

Back on Left Side

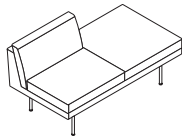

Back on Right Side

			A	B	C	D	E	F	G	H	I
			J	K	L	M	N	O	P	Q	R
K89PE2LTB	Back on Left Side	\$	4293	4487	4636	4790	4954	5148	5259	5469	5645
			5827	6120	6700	7069	7152	7224	7313	7401	7809
K89PE2RTB	Back on Right Side		4293	4487	4636	4790	4954	5148	5259	5469	5645
			5827	6120	6700	7069	7152	7224	7313	7401	7809

DIMENSIONS

Width	55½	Seat Height	18½	Weight	107
Depth	29¾	Seat Depth	20½	Cubic Ft.	36.00
Height	29⅜	Seat Width	55½		

- Contrasting fabric option – specify X (i.e., K89PE2LTBX); see page 764. For list pricing, use your electronic specification tool or contact customer service
- Weight Limit 253 lbs.
- Tight-back
- Clean out
- 2mm tubular metal legs
- Non-skid, adjustable glides

THREE SEAT ARMLESS, PENINSULA LOUNGE

MODEL NO.

ALLIANCE PROGRAM PRICE GRADES

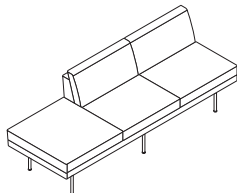

Back on Left Side

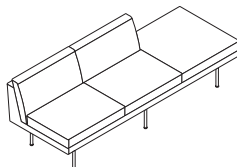

Back on Right Side

			A	B	C	D	E	F	G	H	I
			J	K	L	M	N	O	P	Q	R
K89PE3LTB	Back on Left Side	\$	5870	6149	6364	6588	6827	7105	7265	7567	7822
			8086	8508	9345	9879	9999	10102	10229	10357	10947
K89PE3RTB	Back on Right Side		5870	6149	6364	6588	6827	7105	7265	7567	7822
			8086	8508	9345	9879	9999	10102	10229	10357	10947

DIMENSIONS

Width	82½	Seat Height	18½	Weight	181
Depth	29¾	Seat Depth	20½	Cubic Ft.	53.00
Height	29⅜	Seat Width	82½		

- Contrasting fabric option – specify X (i.e., K89PE3LTBX); see page 764. For list pricing, use your electronic specification tool or contact customer service
- Weight Limit 253 lbs.
- Tight-back
- Clean out
- 2mm tubular metal legs
- Non-skid, adjustable glides

TO ORDER, SPECIFY:

- 1. Model Number
- 2. Inner Back Upholstery Grade
- 3. Inner Back Upholstery Number
- 4. Outer Back Upholstery Grade
- 5. Outer Back Upholstery Number
- 6. Seat Upholstery Grade
- 7. Seat Upholstery Number
- 8. Arm Upholstery Grade
- 9. Arm Upholstery Number
- 10. Front Panel/Accent Upholstery Grade
- 11. Front Panel/Accent Upholstery Number
- 12. Leg Metal Finish Designator
- 13. Arm Cap Finish or Color Designator (if applicable)
- 14. Moisture Barrier Optional for Seat, or Seat and Inside Back

- See page 763 for Whittaker Health options
- See pages 797-802 for COM fabric yardage

TWO SEAT BACK AND CONVENIENCE ARM ON LEFT, PENINSULA LOUNGE

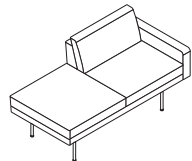

No Arm Cap

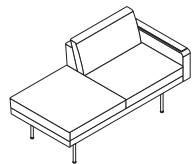

Arm Cap

MODEL NO.

ALLIANCE PROGRAM PRICE GRADES

		A	B	C	D	E	F	G	H	I
		J	K	L	M	N	O	P	Q	R
K89PE2RCVARUTB	No Arm Cap	\$ 4984	5223	5407	5597	5799	6038	6174	6433	6650
		6874	7235	7950	8404	8506	8595	8705	8813	9316
K89PE2RCVARACWTB	Wood Arm Cap	5040	5279	5463	5653	5855	6094	6230	6489	6706
		6930	7291	8006	8460	8562	8651	8761	8869	9372
K89PE2RCVARACPTB	Polyurethane Arm Cap	5073	5312	5496	5686	5888	6127	6263	6522	6739
		6963	7324	8039	8493	8595	8684	8794	8902	9405
K89PE2RCVARACTTB	3D Laminate Arm Cap	5200	5439	5623	5813	6015	6254	6390	6649	6866
		7090	7451	8166	8620	8722	8811	8921	9029	9532
K89PE2RCVARACSTB	Solid Surface Arm Cap	5427	5666	5850	6040	6242	6481	6617	6876	7093
		7317	7678	8393	8847	8949	9038	9148	9256	9759

DIMENSIONS

Width	58%	Seat Height	18%	Arm Height		Weight	115
Depth	29%	Seat Depth	20%	No Arm Cap	22 ³ / ₁₆	Cubic Ft.	38.00
Height	29 ¹³ / ₁₆	Seat Width	55%	Arm Cap	22 ¹ / ₁₆		
				Arm Width	3 ¹ / ₂		

- Contrasting fabric option – specify X (i.e., K89PE2RCVARUTBX); see page 764. For list pricing, use your electronic specification tool or contact customer service
- Weight Limit 253 lbs.
- Tight-back
- Clean out
- 2mm tubular metal legs
- Non-skid, adjustable glides
- Arm cap on applicable models

THREE SEAT BACK AND CONVENIENCE ARM ON LEFT, PENINSULA LOUNGE

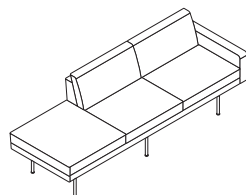

No Arm Cap

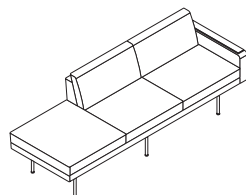

Arm Cap

		A	B	C	D	E	F	G	H	I
		J	K	L	M	N	O	P	Q	R
K89PE3RCVARUTB	No Arm Cap	\$ 6351	6675	6925	7185	7462	7785	7970	8321	8617
		8923	9413	10385	11004	11143	11263	11411	11559	12244
K89PE3RCVARACWTB	Wood Arm Cap	6568	6892	7142	7402	7679	8002	8187	8538	8834
		9140	9630	10602	11221	11360	11480	11628	11776	12461
K89PE3RCVARACPTB	Polyurethane Arm Cap	6723	7047	7297	7557	7834	8157	8342	8693	8989
		9295	9785	10757	11376	11515	11635	11783	11931	12616
K89PE3RCVARACTTB	3D Laminate Arm Cap	6852	7176	7426	7686	7963	8286	8471	8822	9118
		9424	9914	10886	11505	11644	11764	11912	12060	12745
K89PE3RCVARACSTB	Solid Surface Arm Cap	7076	7400	7650	7910	8187	8510	8695	9046	9342
		9648	10138	11110	11729	11868	11988	12136	12284	12969

DIMENSIONS

Width	88	Seat Height	18%	Arm Height		Weight	188
Depth	29%	Seat Depth	20%	No Arm Cap	22 ³ / ₁₆	Cubic Ft.	56.00
Height	29 ¹³ / ₁₆	Seat Width	25%	Arm Cap	22 ¹ / ₁₆		
				Arm Width	3 ¹ / ₂		

- Contrasting fabric option – specify X (i.e., K89PE3RCVARUTBX); see page 764. For list pricing, use your electronic specification tool or contact customer service
- Weight Limit 253 lbs.
- Tight-back
- Clean out
- 2mm tubular metal legs
- Non-skid, adjustable glides
- Arm cap on applicable models

WHITTAKER HEALTH

TO ORDER, SPECIFY:

1. Model Number
2. Inner Back Upholstery Grade
3. Inner Back Upholstery Number
4. Outer Back Upholstery Grade
5. Outer Back Upholstery Number
6. Seat Upholstery Grade
7. Seat Upholstery Number
8. Arm Upholstery Grade
9. Arm Upholstery Number
10. Front Panel/Accent Upholstery Grade
11. Front Panel/Accent Upholstery Number
12. Leg Metal Finish Designator
13. Arm Cap Finish or Color Designator (if applicable)
14. Moisture Barrier Optional for Seat, or Seat and Inside Back

- See page 763 for Whittaker Health options
- See pages 797-802 for COM fabric yardage

TWO SEAT BACK AND CONVENIENCE ARM ON RIGHT, PENINSULA LOUNGE

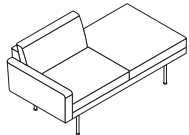

No Arm Cap

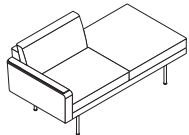

Arm Cap

MODEL NO.

ALLIANCE PROGRAM PRICE GRADES

			A	B	C	D	E	F	G	H	I
			J	K	L	M	N	O	P	Q	R
K89PE2LCVALUTB	No Arm Cap	\$	4984	5223	5407	5597	5799	6038	6174	6433	6650
			6874	7235	7950	8404	8506	8595	8705	8813	9316
K89PE2LCVALACWTB	Wood Arm Cap		5040	5279	5463	5653	5855	6094	6230	6489	6706
			6930	7291	8006	8460	8562	8651	8761	8869	9372
K89PE2LCVALACPTB	Polyurethane Arm Cap		5073	5312	5496	5686	5888	6127	6263	6522	6739
			6963	7324	8039	8493	8595	8684	8794	8902	9405
K89PE2LCVALACTTB	3D Laminate Arm Cap		5200	5439	5623	5813	6015	6254	6390	6649	6866
			7090	7451	8166	8620	8722	8811	8921	9029	9532
K89PE2LCVALACSTB	Solid Surface Arm Cap		5427	5666	5850	6040	6242	6481	6617	6876	7093
			7317	7678	8393	8847	8949	9038	9148	9256	9759

DIMENSIONS

Width	58%	Seat Height	18%	Arm Height		Weight	115
Depth	29%	Seat Depth	20%	No Arm Cap	22 ³ / ₁₆	Cubic Ft.	38.00
Height	29 ³ / ₁₆	Seat Width	55%	Arm Cap	22 ¹ / ₁₆		
				Arm Width	3 ¹ / ₂		

- Contrasting fabric option – specify X (i.e., K89PE2LCVALUTBX); see page 764. For list pricing, use your electronic specification tool or contact customer service
- Weight Limit 253 lbs.
- Tight-back
- Clean out
- 2mm tubular metal legs
- Non-skid, adjustable glides
- Arm cap on applicable models

THREE SEAT BACK AND CONVENIENCE ARM ON RIGHT, PENINSULA LOUNGE

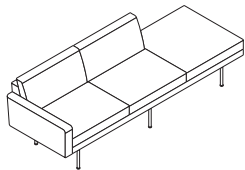

No Arm Cap

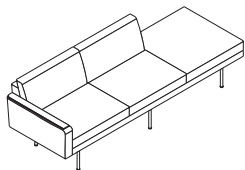

Arm Cap

			A	B	C	D	E	F	G	H	I
			J	K	L	M	N	O	P	Q	R
K89PE3LCVALUTB	No Arm Cap	\$	6351	6675	6925	7185	7462	7785	7970	8321	8617
			8923	9413	10385	11004	11143	11263	11411	11559	12244
K89PE3LCVALACWTB	Wood Arm Cap		6568	6892	7142	7402	7679	8002	8187	8538	8834
			9140	9630	10602	11221	11360	11480	11628	11776	12461
K89PE3LCVALACPTB	Polyurethane Arm Cap		6723	7047	7297	7557	7834	8157	8342	8693	8989
			9295	9785	10757	11376	11515	11635	11783	11931	12616
K89PE3LCVALACTTB	3D Laminate Arm Cap		6852	7176	7426	7686	7963	8286	8471	8822	9118
			9424	9914	10886	11505	11644	11764	11912	12060	12745
K89PE3LCVALACSTB	Solid Surface Arm Cap		7076	7400	7650	7910	8187	8510	8695	9046	9342
			9648	10138	11110	11729	11868	11988	12136	12284	12969

DIMENSIONS

Width	88	Seat Height	18%	Arm Height		Weight	188
Depth	29%	Seat Depth	20%	No Arm Cap	22 ³ / ₁₆	Cubic Ft.	56.00
Height	29 ³ / ₁₆	Seat Width	25%	Arm Cap	22 ¹ / ₁₆		
				Arm Width	3 ¹ / ₂		

- Contrasting fabric option – specify X (i.e., K89PE3LCVALUTBX); see page 764. For list pricing, use your electronic specification tool or contact customer service
- Weight Limit 253 lbs.
- Tight-back
- Clean out
- 2mm tubular metal legs
- Non-skid, adjustable glides
- Arm cap on applicable models

TO ORDER, SPECIFY:

1. Model Number
2. Inner Back Upholstery Grade
3. Inner Back Upholstery Number
4. Outer Back Upholstery Grade
5. Outer Back Upholstery Number
6. Seat Upholstery Grade
7. Seat Upholstery Number
8. Arm Upholstery Grade
9. Arm Upholstery Number
10. Front Panel/Accent Upholstery Grade
11. Front Panel/Accent Upholstery Number
12. Leg Metal Finish Designator
13. Moisture Barrier Optional for Seat, or Seat and Inside Back

- See page 763 for Whittaker Health options
- See pages 797-802 for COM fabric yardage

THREE SEAT INTERIOR ARM, PENINSULA LOUNGE

MODEL NO. ALLIANCE PROGRAM PRICE GRADES

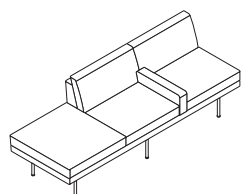

Back on Left Side

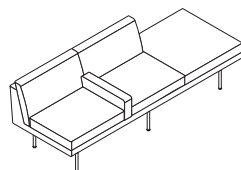

Back on Right Side

MODEL NO.	DESCRIPTION	PRICE	A	B	C	D	E	F	G	H	I
			J	K	L	M	N	O	P	Q	R
K89PE3LILTB	Back on Left Side	\$	5636	5930	6156	6391	6641	6934	7103	7420	7688
			7966	8409	9290	9851	9977	10085	10219	10354	10974
K89PE3RIRTB	Back on Right Side		5636	5930	6156	6391	6641	6934	7103	7420	7688
			7966	8409	9290	9851	9977	10085	10219	10354	10974

DIMENSIONS

Width	86	Seat Height	18 $\frac{1}{2}$	Weight	188
Depth	29 $\frac{3}{4}$	Seat Depth	20 $\frac{1}{16}$	Cubic Ft.	53.00
Height	29 $\frac{3}{16}$	Seat Width	25 $\frac{3}{16}$		

- Contrasting fabric option – specify X (i.e., K89PE3LILTBX); see page 764. For list pricing, use your electronic specification tool or contact customer service
- Weight Limit 253 lbs.
- Tight-back
- Clean out
- 2mm tubular metal legs
- Non-skid, adjustable glides

WHITTAKER HEALTH

TO ORDER, SPECIFY:

1. Model Number
2. Inner Back Upholstery Grade
3. Inner Back Upholstery Number
4. Outer Back Upholstery Grade
5. Outer Back Upholstery Number
6. Seat Upholstery Grade
7. Seat Upholstery Number
8. Front Panel/Accent Upholstery Grade
9. Front Panel/Accent Upholstery Number
10. Leg Metal Finish Designator
11. Moisture Barrier Optional for Seat, or Seat and Inside Back

- See page 763 for Whittaker Health options
- See pages 797-802 for COM fabric yardage

TWO SEAT CORNERS, PENINSULA LOUNGE

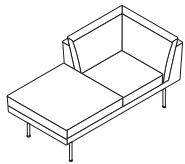

Left Corner

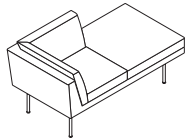

Right Corner

MODEL NO.

ALLIANCE PROGRAM PRICE GRADES

			A	B	C	D	E	F	G	H	I
			J	K	L	M	N	O	P	Q	R
K89CP2LTB	Left Corner	\$	4594	4809	4974	5147	5332	5546	5669	5902	6099
			6302	6627	7270	7683	7776	7855	7952	8051	8505
K89CP2RTB	Right Corner		4594	4809	4974	5147	5332	5546	5669	5902	6099
			6302	6627	7270	7683	7776	7855	7952	8051	8505

DIMENSIONS

Width	57 $\frac{1}{16}$	Seat Height	18 $\frac{1}{16}$	Weight	140
Depth	29 $\frac{3}{16}$	Seat Depth	20 $\frac{1}{16}$	Cubic Ft.	37.00
Height	29 $\frac{13}{16}$	Seat Width	51 $\frac{1}{4}$		

- Contrasting fabric option – specify X (i.e., K89CP2LTBX); see page 764. For list pricing, use your electronic specification tool or contact customer service
- Weight Limit 253 lbs.
- Tight-back
- Clean out
- 2mm tubular metal legs
- Non-skid, adjustable glides

THREE SEAT CORNERS, PENINSULA LOUNGE

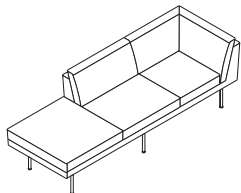

Back on Left Side

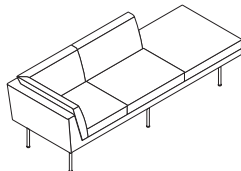

Back on Right Side

			A	B	C	D	E	F	G	H	I
			J	K	L	M	N	O	P	Q	R
K89CP3LTB	Back on Left Side	\$	5953	6250	6479	6717	6973	7270	7440	7763	8035
			8316	8766	9658	10228	10356	10466	10601	10738	11367
K89CP3RTB	Back on Right Side		5953	6250	6479	6717	6973	7270	7440	7763	8035
			8316	8766	9658	10228	10356	10466	10601	10738	11367

DIMENSIONS

Width	84 $\frac{1}{2}$	Seat Height	18 $\frac{1}{16}$	Weight	200
Depth	29 $\frac{3}{16}$	Seat Depth	20 $\frac{1}{16}$	Cubic Ft.	55.00
Height	29 $\frac{13}{16}$	Seat Width	74 $\frac{1}{16}$		

- Contrasting fabric option – specify X (i.e., K89CP3LTBX); see page 764. For list pricing, use your electronic specification tool or contact customer service
- Weight Limit 253 lbs.
- Tight-back
- Clean out
- 2mm tubular metal legs
- Non-skid, adjustable glides

TO ORDER, SPECIFY:

1. Model Number
2. Seat Upholstery Grade
3. Seat Upholstery Number
4. Front Panel/Accent Upholstery Grade
5. Front Panel/Accent Upholstery Number
6. Leg Metal Finish Designator
7. Moisture Barrier Optional for Seat, or Seat and Inside Back

- See page 763 for Whittaker Health options
- See pages 797-802 for COM fabric yardage

BENCHES

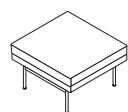

One Seat

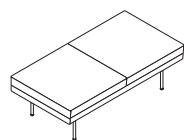

Two Seat

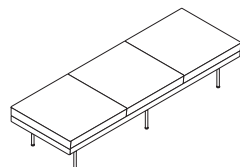

Three Seat

MODEL NO.

ALLIANCE PROGRAM PRICE GRADES

			A	B	C	D	E	F	G	H	I
			J	K	L	M	N	O	P	Q	R
K89BE1	One Seat	\$	1857	1932	1990	2050	2114	2189	2232	2314	2382
			2452	2566	2790	2934	2966	2994	3028	3062	3221
K89BE2	Two Seat		2935	3066	3167	3271	3381	3512	3586	3728	3846
			3969	4166	4557	4806	4863	4910	4970	5030	5306
K89BE3	Three Seat		3722	3904	4044	4189	4345	4526	4630	4827	4993
			5165	5440	5985	6332	6411	6478	6561	6644	7028

DIMENSIONS - ONE SEAT

Width	27½	Weight	58
Depth	28½	Cubic Ft.	11.00
Height	17½		

DIMENSIONS - TWO SEAT

Width	55½	Weight	96
Depth	28½	Cubic Ft.	21.00
Height	17½		

DIMENSIONS - THREE SEAT

Width	82½	Weight	140
Depth	28½	Cubic Ft.	31.00
Height	17½		

- Contrasting fabric option – specify X (i.e., K89BE1X); see page 764. For list pricing, use your electronic specification tool or contact customer service
- Weight Limit 253 lbs.
- 2mm tubular metal legs
- Non-skid, adjustable glides

WHITTAKER HEALTH

WHITTAKER HEALTH

TO ORDER, SPECIFY:

• See page 763 for Whittaker Health options

1. Model Number

GANGING DEVICE



MODEL NO.

LIST PRICE

K82PGB	Ganging Device	\$	54
--------	----------------	----	----

DIMENSIONS

Weight	2
Cubic Ft.	1.00

- Two two-piece ganging devices are required to join two units together

POWER/USB MODULE

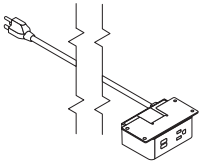

K87EUM	White	\$	429
--------	-------	----	-----

DIMENSIONS

Width	4.05
Depth	2.77
Height	1.69

Weight	2
Cubic Ft.	1.00

- Can be placed under all Whittaker lounge models
- 6' cord with three-prong plug
- 1 power receptacle
- 2 USB ports

COM YARDAGE REQUIREMENTS

COM YARDAGE REQUIREMENTS (54" WIDTH – CUT UP THE ROLL)

MODEL	RAILROADED Contact customer service 800-634-9510 for ydg requirements	NON DIRECTIONAL OR SOLID	1"-4" REPEAT	5"-11" REPEAT	12"-18" REPEAT	COL SQUARE FEET
			4" VERTICAL X 4" HORIZONTAL	11" VERTICAL X 11" HORIZONTAL	18" VERTICAL X 18" HORIZONTAL	
K89L1XATB	Entire Unit	3.50	4.50	5.00	6.00	70.3
	Inner Back	1.30	1.80	2.00	2.50	25.5
	Outer Back	1.20	1.50	2.00	2.80	24.4
	Seat	0.90	1.30	2.00	2.00	18.3
	Accent	0.50	1.00	1.50	2.30	10
K89L2XATB	Entire Unit	5.90	7.50	8.50	9.50	118.4
	Inner Back	2.50	3.00	3.50	4.50	49.3
	Outer Back	1.50	2.00	3.00	4.50	29.9
	Seat	1.80	2.00	3.00	3.00	34.9
	Accent	0.60	1.00	1.80	2.80	11.1
K89L3XATB	Entire Unit	9.10	10.50	12.00	14.00	181
	Inner Back	3.70	4.50	5.00	6.50	73.1
	Outer Back	2.20	3.00	4.00	6.00	43.2
	Seat	2.60	3.00	4.00	3.50	51.5
	Accent	0.80	1.50	2.00	3.30	14.9
K89L1CVALUTB, K89L1CVALACWTB, K89L1CVALACPTB, K89L1CVALACTTB, K89L1CVALACSTB	Entire Unit	4.30	5.00	6.00	7.00	84.7
	Inner Back	1.30	1.80	2.00	2.50	25.5
	Outer Back	1.20	1.50	2.00	2.80	24.4
	Seat	0.90	1.30	2.00	2.00	18.3
	Arm	1.40	1.50	1.80	2.50	28.2
	Accent	0.50	1.00	1.50	2.30	10
K89L2CVALUTB, K89L2CVALACWTB, K89L2CVALACPTB, K89L2CVALACTTB, K89L2CVALACSTB	Entire Unit	6.60	8.00	9.00	10.50	132.3
	Inner Back	2.50	3.00	3.50	4.50	49.3
	Outer Back	1.50	2.00	3.00	4.50	29.9
	Seat	1.80	2.00	3.00	3.00	34.9
	Arm	1.30	1.50	1.80	2.50	25.5
	Accent	0.60	1.00	1.80	2.80	11.1
K89L3CVALUTB, K89L3CVALACWTB, K89L3CVALACPTB, K89L3CVALACTTB, K89L3CVALACSTB	Entire Unit	9.60	11.30	12.50	14.50	190.4
	Inner Back	3.60	4.50	5.00	6.50	72.5
	Outer Back	2.10	3.00	4.00	6.00	42.6
	Seat	2.10	3.00	4.00	3.50	41
	Arm	1.30	1.50	1.80	2.50	25.5
	Accent	0.70	1.50	2.00	3.30	14.4
K89L1CVARUTB, K89L1CVARACWTB, K89L1CVARACPTB, K89L1CVARACTTB, K89L1CVARACSTB	Entire Unit	4.30	5.00	6.00	7.00	84.7
	Inner Back	1.30	1.80	2.00	2.50	25.5
	Outer Back	1.20	1.50	2.00	2.80	24.4
	Seat	0.90	1.30	2.00	2.00	18.3
	Arm	1.40	1.50	1.80	2.50	28.2
	Accent	0.50	1.00	1.50	2.30	10
K89L2CVARUTB, K89L2CVARACWTB, K89L2CVARACPTB, K89L2CVARACTTB, K89L2CVARACSTB	Entire Unit	6.60	8.00	9.00	10.50	132.3
	Inner Back	2.50	3.00	3.50	4.50	49.3
	Outer Back	1.50	2.00	3.00	4.50	29.9
	Seat	1.80	2.00	3.00	3.00	34.9
	Arm	1.30	1.50	1.80	2.50	25.5
	Accent	0.60	1.00	1.80	2.80	11.1
K89L3CVARUTB, K89L3CVARACWTB, K89L3CVARACPTB, K89L3CVARACTTB, K89L3CVARACSTB	Entire Unit	9.60	11.30	12.50	14.50	190.4
	Inner Back	3.60	4.50	5.00	6.50	72.5
	Outer Back	2.10	3.00	4.00	6.00	42.6
	Seat	2.10	3.00	4.00	3.50	41
	Arm	1.30	1.50	1.80	2.50	25.5
	Accent	0.70	1.50	2.00	3.30	14.4
K89L1CVABUTB, K89L1CVABACWTB, K89L1CVABACPTB, K89L1CVABACTTB, K89L1CVABACSTB	Entire Unit	5.00	6.00	7.00	8.00	99.1
	Inner Back	1.30	1.80	2.00	2.50	25.5
	Outer Back	1.20	1.50	2.00	2.80	24.4
	Seat	0.90	1.30	2.00	2.00	18.3
	Arms	1.50	2.00	3.00	3.80	30.4
	Accent	0.50	1.00	1.50	2.30	10

COM YARDAGE REQUIREMENTS

COM YARDAGE REQUIREMENTS (54" WIDTH – CUT UP THE ROLL)

MODEL	RAILROADED Contact customer service 800-634-9510 for ydg requirements	NON DIRECTIONAL OR SOLID	1"-4" REPEAT	5"-11" REPEAT	12"-18" REPEAT	COL SQUARE FEET
			4" VERTICAL X 4" HORIZONTAL	11" VERTICAL X 11" HORIZONTAL	18" VERTICAL X 18" HORIZONTAL	
K89L2CVABUTB,	Entire Unit	7.40	9.00	10.00	11.50	147.2
K89L2CVABACWTB,	Inner Back	2.50	3.00	3.50	4.50	49.2
K89L2CVABACPTB,	Outer Back	1.50	2.00	3.00	4.50	29.9
K89L2CVABACTTB,	Seat	1.80	2.00	3.00	3.00	34.9
K89L2CVABACSTB	Arms	1.50	2.00	3.00	3.80	30.4
	Accent	0.60	1.00	1.80	2.80	11.1
K89L3CVABUTB,	Entire Unit	10.30	12.00	13.50	15.50	204.8
K89L3CVABACWTB,	Inner Back	3.60	4.50	5.00	6.50	72.5
K89L3CVABACPTB,	Outer Back	2.10	3.00	4.00	6.00	42.6
K89L3CVABACTTB,	Seat	2.10	3.00	4.00	3.50	41
K89L3CVABACSTB	Arms	1.50	2.00	3.00	3.80	30.4
	Accent	0.70	1.50	2.00	3.30	14.4
K89L1FALTB, K89L1FARTB	Entire Unit	4.40	5.50	6.50	7.00	88.6
	Inner Back	1.30	1.80	2.00	2.50	25.5
	Outer Back	1.20	1.50	2.00	2.80	24.4
	Seat	0.90	1.30	2.00	2.00	18.3
	Arm	1.40	1.80	2.00	2.50	28.2
	Accent	0.50	1.00	1.50	2.30	10
K89L1FABTB	Entire Unit	5.50	6.50	7.50	8.00	109.6
	Inner Back	1.30	1.80	2.00	2.50	25.5
	Outer Back	1.20	1.50	2.00	2.80	24.4
	Seat	0.90	1.30	2.00	2.00	18.3
	Arms	2.10	2.50	3.30	4.50	41.5
	Accent	0.50	1.00	1.50	2.30	10
K89L2FALTB, K89L2FARTB	Entire Unit	6.90	8.50	10.00	11.00	138.4
	Inner Back	2.50	3.00	3.50	4.50	49.3
	Outer Back	1.50	2.00	3.00	4.50	29.9
	Seat	1.80	2.00	3.00	3.00	34.9
	Arm	1.40	1.80	2.00	2.50	28.2
	Accent	0.60	1.00	1.80	2.80	11.1
K89L2FABTB	Entire Unit	7.90	9.50	11.00	12.00	157.7
	Inner Back	2.50	3.00	3.50	4.50	49.3
	Outer Back	1.50	2.00	3.00	4.50	29.9
	Seat	1.80	2.00	3.00	3.00	34.9
	Arms	2.10	2.50	3.30	4.50	41.5
	Accent	0.60	1.00	1.80	2.80	11.1
K89L3FALTB, K89L3FARTB	Entire Unit	9.80	12.00	13.00	15.00	195.9
	Inner Back	3.60	4.50	5.00	6.50	72.5
	Outer Back	2.10	3.00	4.00	6.00	42.6
	Seat	2.10	3.00	4.00	3.50	41
	Arm	1.40	1.80	2.00	2.50	28.2
	Accent	0.70	1.50	2.00	3.30	14.4
K89L3FABTB	Entire Unit	10.80	13.00	14.50	16.50	215.3
	Inner Back	3.60	4.50	5.00	6.50	72.5
	Outer Back	2.10	3.00	4.00	6.00	42.6
	Seat	2.10	3.00	4.00	3.50	41
	Arms	2.10	2.50	3.30	4.50	41.5
	Accent	0.70	1.50	2.00	3.30	14.4
K89L2XAIBT	Entire Unit	5.10	7.50	8.50	10.50	101.8
	Inner Back	2.50	3.00	3.50	4.50	49.3
	Outer Back	1.50	2.00	3.00	4.50	29.9
	Seat	1.50	2.00	3.00	3.00	30.4
	Arm	1.20	1.40	1.50	2.00	24.4
	Accent	0.60	1.00	1.80	2.80	11.1
K89L3XAIBT, K89L3XAIRTB	Entire Unit	10.10	10.50	12.00	14.50	202
	Inner Back	2.10	3.00	4.00	3.50	41
	Outer Back	2.10	3.00	4.00	6.00	42.6
	Seat	2.10	3.00	4.00	3.50	41
	Arm	1.20	1.40	1.50	2.00	24.4
	Accent	0.70	1.50	2.00	3.30	14.4

COM YARDAGE REQUIREMENTS

COM YARDAGE REQUIREMENTS (54" WIDTH – CUT UP THE ROLL)

MODEL	RAILROADED Contact customer service 800-634-9510 for ydg requirements	NON DIRECTIONAL OR SOLID	1"-4" REPEAT	5"-11" REPEAT	12"-18" REPEAT	COL SQUARE FEET
			4" VERTICAL X 4" HORIZONTAL	11" VERTICAL X 11" HORIZONTAL	18" VERTICAL X 18" HORIZONTAL	
K89L3XAIBTB	Entire Unit	10.10	11.00	12.50	15.50	202
	Inner Back	3.60	4.50	5.00	6.50	72.5
	Outer Back	2.10	3.00	4.00	6.00	42.6
	Seat	2.10	3.00	4.00	3.50	41
	Arm	1.20	1.50	2.50	2.80	24.4
	Accent	0.70	1.50	2.00	3.30	14.4
K89L2CVALIUTB, K89L2CVALIACWTB, K89L2CVALIACPTB, K89L2CVALIACSTB	Entire Unit	5.90	8.00	9.00	11.50	117.3
	Inner Back	2.50	3.00	3.50	4.50	49.3
	Outer Back	1.50	2.00	3.00	4.50	29.9
	Seat	1.80	2.00	3.00	3.00	34.9
	Arms	1.40	1.80	2.50	3.00	28.2
	Accent	0.60	1.00	1.80	2.80	11.1
K89L2CVARIUTB, K89L2CVARIACWTB, K89L2CVARIACPTB, K89L2CVARIACSTB	Entire Unit	5.90	8.00	9.00	11.50	117.3
	Inner Back	2.50	3.00	3.50	4.50	49.3
	Outer Back	1.50	2.00	3.00	4.50	29.9
	Seat	1.80	2.00	3.00	3.00	34.9
	Arms	1.40	1.80	2.50	3.00	28.2
	Accent	0.60	1.00	1.80	2.80	11.1
K89L2CVABIUTB, K89L2CVABIACWTB, K89L2CVABIACPTB, K89L2CVABIACSTB	Entire Unit	6.60	9.00	10.50	12.50	130.6
	Inner Back	2.50	3.00	3.50	4.50	49.3
	Outer Back	1.50	2.00	3.00	4.50	29.9
	Seat	1.80	2.00	3.00	3.00	34.9
	Arms	1.70	2.50	4.50	5.00	33.2
	Accent	0.60	1.00	1.80	2.80	11.1
K89L3CVARILUTB, K89L3CVARILACWTB, K89L3CVARILACPTB, K89L3CVARILACTTB, K89L3CVARILACSTB	Entire Unit	8.70	11.30	13.00	15.50	173.8
	Inner Back	3.60	4.50	5.00	6.50	72.5
	Outer Back	2.10	3.00	4.00	6.00	42.6
	Seat	2.10	3.00	4.00	3.50	41
	Arms	1.30	1.80	2.50	3.00	25.5
	Accent	0.70	1.50	2.00	3.30	14.4
K89L3CVABILUTB, K89L3CVABILACWTB, K89L3CVABILACPTB, K89L3CVABILACTTB, K89L3CVABILACSTB	Entire Unit	9.40	12.50	14.00	16.50	188.2
	Inner Back	3.60	4.50	5.00	6.50	72.5
	Outer Back	2.10	3.00	4.00	6.00	42.6
	Seat	2.10	3.00	4.00	3.50	41
	Arms	1.70	2.50	4.50	5.00	33.2
	Accent	0.70	1.50	2.00	3.30	14.4
K89L3CVALIRUTB, K89L3CVALIRACWTB, K89L3CVALIRACPTB, K89L3CVALIRACTTB, K89L3CVALIRACSTB	Entire Unit	8.70	11.30	13.00	15.50	173.8
	Inner Back	3.60	4.50	5.00	6.50	72.5
	Outer Back	2.10	3.00	4.00	6.00	42.6
	Seat	2.10	3.00	4.00	3.50	41
	Arms	1.30	1.80	2.50	3.00	25.5
	Accent	0.70	1.50	2.00	3.30	14.4
K89L3CVABIRUTB, K89L3CVABIRACWTB, K89L3CVABIRACPTB, K89L3CVABIRACTTB, K89L3CVABIRACSTB	Entire Unit	9.40	12.50	14.00	16.50	188.2
	Inner Back	3.60	4.50	5.00	6.50	72.5
	Outer Back	2.10	3.00	4.00	6.00	42.6
	Seat	2.10	3.00	4.00	3.50	41
	Arms	1.70	2.50	4.50	5.00	33.2
	Accent	0.70	1.50	2.00	3.30	14.4
K89L3CVARIBUTB, K89L3CVARIBACWTB, K89L3CVARIBACPTB, K89L3CVARIBACTTB, K89L3CVARIBACSTB	Entire Unit	8.00	11.50	13.50	16.30	159.4
	Inner Back	3.60	4.50	5.00	6.50	72.5
	Outer Back	2.10	3.00	4.00	6.00	42.6
	Seat	2.10	3.00	4.00	3.50	41
	Arms	1.90	3.00	4.50	5.00	38.7
	Accent	0.70	1.50	2.00	3.30	14.4
K89L3CVALIBUTB, K89L3CVALIBACWTB, K89L3CVALIBACPTB, K89L3CVALIBACTTB, K89L3CVALIBACSTB	Entire Unit	8.00	11.50	13.50	16.30	159.4
	Inner Back	3.60	4.50	5.00	6.50	72.5
	Outer Back	2.10	3.00	4.00	6.00	42.6
	Seat	2.10	3.00	4.00	3.50	41
	Arms	1.90	3.00	4.50	5.00	38.7
	Accent	0.70	1.50	2.00	3.30	14.4

WHITTAKER HEALTH

COM YARDAGE REQUIREMENTS

COM YARDAGE REQUIREMENTS (54" WIDTH – CUT UP THE ROLL)

MODEL	RAILROADED Contact customer service 800-634-9510 for ydg requirements	NON DIRECTIONAL OR SOLID	1"-4" REPEAT	5"-11" REPEAT	12"-18" REPEAT	COL SQUARE FEET
			4" VERTICAL X 4" HORIZONTAL	11" VERTICAL X 11" HORIZONTAL	18" VERTICAL X 18" HORIZONTAL	
K89L3CVABIBUTB,	Entire Unit	8.60	12.50	15.00	17.50	171.6
K89L3CVABIBACWTB,	Inner Back	3.60	4.50	5.00	6.50	72.5
K89L3CVABIBACPTB,	Outer Back	2.10	3.00	4.00	6.00	42.6
K89L3CVABIBACTTB,	Seat	2.10	3.00	4.00	3.50	41
K89L3CVABIBACSTB	Arms	1.90	3.00	4.50	5.00	38.7
	Accent	0.70	1.50	2.00	3.30	14.4
K89C2LXATB	Entire Unit	6.20	8.50	10.50	12.50	123.4
	Inner Back	3.00	4.50	5.00	6.00	59.8
	Outer Back	2.20	2.80	4.00	5.30	43.2
	Seat	1.60	2.00	2.50	2.50	32.1
	Accent	0.50	1.00	1.50	2.30	10
K89C3LXATB	Entire Unit	9.30	12.00	14.00	16.50	184.8
	Inner Back	3.10	3.80	5.80	6.50	75.8
	Outer Back	2.90	3.50	5.00	7.30	57
	Seat	2.30	2.80	4.00	3.50	45.9
	Accent	0.60	1.00	1.80	2.80	11.6
K89C2LCVAUTB,	Entire Unit	6.90	9.00	11.00	13.00	137.3
K89C2LCVAACWTB,	Inner Back	3.00	4.50	5.00	6.00	59.8
K89C2LCVAACPTB,	Outer Back	2.20	2.80	4.00	5.30	43.2
K89C2LCVAACTTB,	Seat	1.60	2.00	2.50	2.50	32.1
K89C2LCVAACSTB	Arm	1.30	1.50	1.80	2.50	25.5
	Accent	0.50	1.00	1.50	2.30	10
K89C3LCVAUTB,	Entire Unit	9.80	12.50	14.50	17.50	194.3
K89C3LCVAACWTB,	Inner Back	3.80	5.80	6.50	7.50	75.8
K89C3LCVAACPTB,	Outer Back	2.90	3.50	5.00	7.30	57
K89C3LCVAACTTB,	Seat	2.30	2.80	4.00	3.50	45.9
K89C3LCVAACSTB	Arm	1.30	1.50	1.80	2.50	25.5
	Accent	0.60	1.00	1.80	2.80	11.6
K89C2LFATB	Entire Unit	7.20	9.50	11.50	13.50	142.8
	Inner Back	3.00	4.50	5.00	6.00	59.8
	Outer Back	2.20	2.80	4.00	5.30	43.2
	Seat	1.60	2.00	2.50	2.50	32.1
	Arm	1.40	1.80	2.00	2.50	28.2
	Accent	0.50	1.00	1.50	2.30	10
K89C3LFATB	Entire Unit	10.10	13.00	15.50	17.50	200.9
	Inner Back	3.80	5.80	6.50	7.50	75.8
	Outer Back	2.90	3.50	5.00	7.30	57
	Seat	2.30	2.80	4.00	3.50	45.9
	Arm	1.40	1.80	2.00	2.50	28.2
	Accent	0.60	1.00	1.80	2.80	11.6
K89C3LXAIRTB	Entire Unit	8.30	12.00	14.00	17.00	164.9
	Inner Back	3.80	5.80	6.50	7.50	75.8
	Outer Back	2.90	3.50	5.00	7.30	57
	Seat	2.30	2.80	4.00	3.50	45.9
	Arm	1.20	1.40	1.50	2.00	12.2
	Accent	0.60	1.00	1.80	2.80	11.6
K89C3LCVAUIRTB,	Entire Unit	9.20	13.00	15.00	18.00	182.6
K89C3LCVAACWIRTB,	Inner Back	3.80	5.80	6.50	7.50	75.8
K89C3LCVAACPIRTB,	Outer Back	2.90	3.50	5.00	7.30	57
K89C3LCVAACIIRTB,	Seat	2.30	2.80	4.00	3.50	45.9
K89C3LCVAACSIIRTB	Arms	1.30	1.80	2.50	3.00	25.5
	Accent	0.60	1.00	1.80	2.80	11.6
K89C2RXATB	Entire Unit	6.20	8.50	10.50	12.50	123.4
	Inner Back	3.00	4.50	5.00	6.00	59.8
	Outer Back	2.20	2.80	4.00	5.30	43.2
	Seat	1.60	2.00	2.50	2.50	32.1
	Accent	0.50	1.00	1.50	2.30	10
K89C3RXATB	Entire Unit	9.30	12.00	14.00	16.50	184.8
	Inner Back	3.10	3.80	5.80	6.50	75.8
	Outer Back	2.90	3.50	5.00	7.30	57
	Seat	2.30	2.80	4.00	3.50	45.9
	Accent	0.60	1.00	1.80	2.80	11.6

COM YARDAGE REQUIREMENTS

COM YARDAGE REQUIREMENTS (54" WIDTH – CUT UP THE ROLL)

MODEL	RAILOADED Contact customer service 800-634-9510 for ydg requirements	NON DIRECTIONAL OR SOLID	1"-4" REPEAT	5"-11" REPEAT	12"-18" REPEAT	COL SQUARE FEET
			4" VERTICAL X 4" HORIZONTAL	11" VERTICAL X 11" HORIZONTAL	18" VERTICAL X 18" HORIZONTAL	
K89C2RCVAUTB,	Entire Unit	6.90	9.00	11.00	13.00	137.3
K89C2RCVAACWTB,	Inner Back	3.00	4.50	5.00	6.00	59.8
K89C2RCVAACPTB,	Outer Back	2.20	2.80	4.00	5.30	43.2
K89C2RCVAACCTB,	Seat	1.60	2.00	2.50	2.50	32.1
K89C2RCVAACSTB	Arm	1.30	1.50	1.80	2.50	25.5
	Accent	0.50	1.00	1.50	2.30	10
K89C3RCVAUTB,	Entire Unit	9.80	12.50	14.50	17.50	194.3
K89C3RCVAACWTB,	Inner Back	3.80	5.80	6.50	7.50	75.8
K89C3RCVAACPTB,	Outer Back	2.90	3.50	5.00	7.30	57
K89C3RCVAACCTB,	Seat	2.30	2.80	4.00	3.50	45.9
K89C3RCVAACSTB	Arm	1.30	1.50	1.80	2.50	25.5
	Accent	0.60	1.00	1.80	2.80	11.6
K89C2RFATB	Entire Unit	7.20	9.50	11.50	13.50	142.8
	Inner Back	3.00	4.50	5.00	6.00	59.8
	Outer Back	2.20	2.80	4.00	5.30	43.2
	Seat	1.60	2.00	2.50	2.50	32.1
	Arm	1.40	1.80	2.00	2.50	28.2
	Accent	0.50	1.00	1.50	2.30	10
K89C3RFATB	Entire Unit	10.10	13.00	15.50	17.50	200.9
	Inner Back	3.80	5.80	6.50	7.50	75.8
	Outer Back	2.90	3.50	5.00	7.30	57
	Seat	2.30	2.80	4.00	3.50	45.9
	Arm	1.40	1.80	2.00	2.50	28.2
	Accent	0.60	1.00	1.80	2.80	11.6
K89C3RXAILTB	Entire Unit	8.30	12.00	14.00	17.00	164.9
	Inner Back	3.80	5.80	6.50	7.50	75.8
	Outer Back	2.90	3.50	5.00	7.30	57
	Seat	2.30	2.80	4.00	3.50	45.9
	Arm	1.20	1.40	1.50	2.00	12.2
	Accent	0.60	1.00	1.80	2.80	11.6
K89C3RCVAUILTB,	Entire Unit	9.20	13.00	15.00	18.00	182.6
K89C3RCVAACWILTB,	Inner Back	3.80	5.80	6.50	7.50	75.8
K89C3RCVAACPILTB,	Outer Back	2.90	3.50	5.00	7.30	57
K89C3RCVAACITLTB,	Seat	2.30	2.80	4.00	3.50	45.9
K89C3RCVAACSILTB	Arms	1.30	1.80	2.50	3.00	25.5
	Accent	0.60	1.00	1.80	2.80	11.6
K89PE2LTB, K89PE2RTB	Entire Unit	5.20	6.00	7.00	8.00	103.5
	Inner Back	1.30	1.80	2.00	2.50	25.5
	Outer Back	1.20	1.50	2.00	2.80	24.4
	Seat	2.10	2.50	3.30	3.30	41.5
	Accent	0.90	1.50	2.00	3.30	18.8
K89PE3LTB, K89PE3RTB	Entire Unit	7.60	9.00	10.50	12.00	152.2
	Inner Back	2.50	3.00	3.50	4.30	49.3
	Outer Back	1.50	2.00	3.00	4.30	29.9
	Seat	2.90	3.30	4.50	4.50	57.6
	Accent	1.10	1.50	2.30	3.80	22.1
K89PE2RCVARUTB,	Entire Unit	5.90	7.00	8.00	9.00	117.3
K89PE2RCVARACWTB,	Inner Back	1.30	1.80	2.00	2.50	25.5
K89PE2RCVARACPTB,	Outer Back	1.20	1.50	2.00	2.80	24.4
K89PE2RCVARACTTB,	Seat	2.10	2.50	3.30	3.30	41.5
K89PE2RCVARACSTB	Arm	1.30	1.50	1.80	2.50	25.5
	Accent	0.90	1.50	2.00	3.30	18.8
K89PE3RCVARUTB,	Entire Unit	8.40	10.00	11.00	13.00	166.6
K89PE3RCVARACWTB,	Inner Back	2.50	3.00	3.50	4.30	49.3
K89PE3RCVARACPTB,	Outer Back	1.50	2.00	3.00	4.30	29.9
K89PE3RCVARACTTB,	Seat	2.90	3.30	4.50	4.50	57.6
K89PE3RCVARACSTB	Arms	1.30	1.50	1.80	2.50	25.5
	Accent	1.10	1.50	2.30	3.80	22.1

WHITTAKER HEALTH

COM YARDAGE REQUIREMENTS

COM YARDAGE REQUIREMENTS (54" WIDTH – CUT UP THE ROLL)

MODEL	RAILROADED Contact customer service 800-634-9510 for ydg requirements	NON DIRECTIONAL OR SOLID	1"-4" REPEAT	5"-11" REPEAT	12"-18" REPEAT	COL SQUARE FEET
			4" VERTICAL X 4" HORIZONTAL	11" VERTICAL X 11" HORIZONTAL	18" VERTICAL X 18" HORIZONTAL	
K89PE2LCVALUTB,	Entire Unit	5.90	7.00	8.00	9.00	117.3
K89PE2LCVALACWTB,	Inner Back	1.30	1.80	2.00	2.50	25.5
K89PE2LCVALACPTB,	Outer Back	1.20	1.50	2.00	2.80	24.4
K89PE2LCVALACCTTB,	Seat	2.10	2.50	3.30	3.30	41.5
K89PE2LCVALACSTB	Arm	1.30	1.50	1.80	2.50	25.5
	Accent	0.90	1.50	2.00	3.30	18.8
K89PE3LCVALUTB,	Entire Unit	8.40	10.00	11.00	13.00	166.6
K89PE3LCVALACWTB,	Inner Back	2.50	3.00	3.50	4.30	49.3
K89PE3LCVALACPTB,	Outer Back	1.50	2.00	3.00	4.30	29.9
K89PE3LCVALACCTTB,	Seat	2.90	3.30	4.50	4.50	57.6
K89PE3LCVALACSTB	Arms	1.30	1.50	1.80	2.50	25.5
	Accent	1.10	1.50	2.30	3.80	22.1
K89PE3LILTB, K89PE3LIRTB	Entire Unit	7.00	9.00	11.00	13.50	139.5
	Inner Back	2.50	3.00	3.50	4.30	49.3
	Outer Back	1.50	2.00	3.00	4.30	29.9
	Seat	2.10	3.30	4.50	4.50	41.5
	Arm	1.20	1.40	1.50	2.00	12.2
	Accent	1.10	1.50	2.30	3.80	22.1
K89CP2LTB, K89CP2RTB	Entire Unit	5.00	7.00	9.00	10.00	99.1
	Inner Back	2.00	3.00	3.50	4.30	40.4
	Outer Back	1.50	2.00	3.00	4.30	29.3
	Seat	1.90	2.50	2.80	2.80	38.2
	Accent	0.70	1.30	1.80	2.80	14.4
K89CP3LTB, K89CP3RTB	Entire Unit	8.20	10.50	12.50	14.50	163.3
	Inner Back	3.00	4.30	4.80	5.80	59.8
	Outer Back	2.20	2.80	3.00	5.80	43.2
	Seat	2.60	3.30	4.00	4.00	52
	Accent	0.70	1.80	2.30	3.80	14.4
K89BE1	Entire Unit	2.00	2.40	3.00	4.50	40.4
	Seat	1.30	1.50	2.30	2.30	24.9
	Accent	0.90	1.20	1.80	2.80	17.7
K89BE2	Entire Unit	3.60	4.00	5.00	7.00	70.8
	Seat	2.40	2.70	3.80	4.00	47
	Accent	1.40	1.60	2.30	4.00	27.1
K89BE3	Entire Unit	5.10	5.80	6.80	9.50	101.3
	Seat	3.50	3.80	5.00	5.30	69.7
	Accent	1.70	2.00	3.00	5.00	33.8