Villa Health

Product Specifications	684
Fabrics and Options	685
Product Pages	687
COM Yardage Requirements	696

VILLA HEALTH PRODUCT SPECIFICATIONS

MOBILE LOUNGE CHAIRS

- Clean out
- 123mm dual wheel casters on front: black
- Non-skid, adjustable glides on back legs
- Rounded handle on back: platinum metallic finish
- EOS^{CU} (Cupron-enhanced EOS) biocidal solid surface arm caps
- Power/USB grommet
- Legs: metal square, round, Y, or wood tapered

MOBILE LOUNGE CHAIRS WITH TABLET ARM

- Clean out
- 123mm dual wheel casters on front: black
- Non-skid, adjustable glides on back legs
- Rounded handle on back: platinum metallic finish
- Tablet arm: HPL or wood
- Tablet arm grommet (NH) to enable tablet arm to be moved to the other arm by user
- Power/USB grommet
- Legs: metal square, round, Y, or wood tapered

LOUNGE CHAIRS, LOVESEATS, SOFAS

- Clean out
- Non-skid, adjustable glides on legs
- EOS^{CU} (Cupron-enhanced EOS) biocidal solid surface arm caps
- Power/USB grommet
- Legs: metal square, round, Y, or wood tapered

LOUNGE CHAIRS, LOVESEATS, SOFAS WITH TABLET ARM

- Clean out
- Non-skid, adjustable glides on legs
- Tablet arm: HPL or wood
- Tablet arm grommet (NH) to enable tablet arm to be moved to the other arm by user
- Power/USB grommet
- Legs: metal square, round, Y, or wood tapered

45° CRESCENT LOUNGE

- Clean out
- Non-skid, adjustable glides on legs

OPTIONAL G55 POWER/USB MODULE

- Single-sided, pneumatic pop-out design: platinum metallic
- 6' cord
- 4" x 5" cut-out

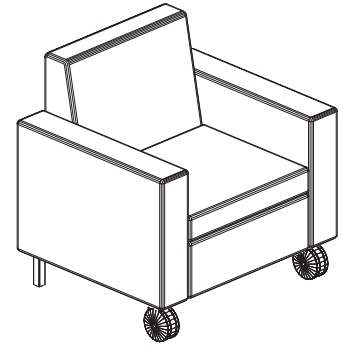

SURFACE MATERIALS

See the Kimball Hospitality Surface Materials Reference Guide at kimballhospitality.com for a complete overview of our materials program, including:

- Characteristics of wood
- Special wood finishes
- Customer specified laminate (CSL)
- Customer specified paint (CSP)
- Fabric application and colorways
- Customer's own material (COM) process overview
- Alliance program

ALLIANCE FABRIC PROGRAM

Kimball Hospitality has analyzed each model to most accurately reflect the COM/COL yardage requirements shown on page 696.

The yardage requirement for each model is based on 54" wide fabric and cutting the fabric up the roll.

If repeat is larger than 18", contact Customer Service to confirm the correct amount of yardage required. When ordering 10 or more chairs in the same COM, yardage requirements may be reduced.

Contact Customer Service.

PRICE GRADES A-R

See Surface Materials at www.kimballhospitality.com for a wide variety of graded-in fabrics from Arc-Com, CF Stinson, Designtex, Maharam, Momentum, and Ultrafabrics.

FABRIC SAMPLES

If you need samples for presentation(s), contact our alliance partners directly at:

Arc-Com	800.223.5466	arc-com.com
Designtex	800.221.1540	designtex.com
CF Stinson	800.841.6279	cfstinson.com
Maharam	800.645.3943	maharam.com
Momentum	800.366.6839	memosamples.com
Ultrafabrics	877.309.6648	ultrafabricsllc.com

ARM CAPS

3D LAMINATE

WOODGRAIN

MC	Amber Cherry
MH	Mocha Cherry
CO	Canyon Straight Grain
DF	Driftwood Straight Grain
YO	Monterey Straight Grain
NW	Tuscan Straight Grain

SOLID SURFACE

STANDARD

405	Designer White
-----	----------------

PREMIUM*

495	EOS ^{CU} Beige
496	EOS ^{CU} Grey
*\$997 Upcharge	

WOOD

AD	Almond	MH	Mocha
MC	Amber	YO	Monterey
IM	Brighton	PB	Portobello
CO	Canyon	792	Sable
CC	Cordoba	SC	Sedona
DF	Driftwood	TW	Tribeca
ES	Espresso	NW	Tuscan
TM	Huntington	UW	Urban
MW	Midtown		

IMPORTANT: Wood finishes applied to solid hardwood are complementary to the same wood finish applied to wood veneer, but not an exact match. Contact Customer Service for more information.

TABLETS

HIGH PRESSURE LAMINATE (HPL)

WOODGRAIN

MC	Amber Cherry
CC	Cordoba Cherry
MH	Mocha Cherry
SC	Sedona Cherry
IM	Brighton Maple
TM	Huntington Maple
MW	Midtown Walnut
TW	Tribeca Walnut
UW	Urban Walnut

SOLID COLOR

480	Antique White
403	Chamois
462	Cinder
440	Cloud
405	Designer White
450	Fog
488	Frosty White
461	Graphite
416	Putty
420	Sandstone
425	Shadow
460	Storm
419	Wallaby

WOOD STRAIGHT GRAIN

AD	Almond Straight Grain
CO	Canyon Straight Grain
DF	Driftwood Straight Grain
YO	Monterey Straight Grain
PB	Portobello Straight Grain
792	Sable Straight Grain
NW	Tuscan Straight Grain

TABLET ARM LOCATION

L	Left as Seated
R	Right as Seated
NH	Non-Handed (\$31 upcharge)
LR	(Loveseats and Sofas) Left and Right as Seated (\$388 upcharge for laminate) (\$416 upcharge for wood)

VILLA HEALTH

CASTERS

42 Black, Hard Dual Wheel

HANDLE

100_PL Round, Platinum Metal

LEG OPTIONS

SQUARE AND ROUND METAL LEGS

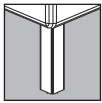

S

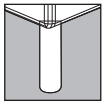

R

SOLID COLOR PAINT

462 Cinder
405 Designer White

METALLIC PAINT

501 Platinum Metallic

Y METAL LEG

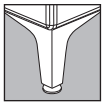

Y

SOLID COLOR PAINT

462 Cinder

METALLIC PAINT

501 Platinum Metallic

NON-PAINT

497 Polished Aluminum

TAPERED WOOD LEG

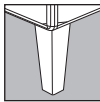

T

WOOD

AD Almond	MH Mocha
MC Amber	YO Monterey
IM Brighton	PB Portobello
CO Canyon	792 Sable
CC Cordoba	SC Sedona
DF Driftwood	TW Tribeca
ES Espresso	NW Tuscan
TM Huntington	UW Urban
MW Midtown	

OPTIONAL G55 POWER/USB MODULE

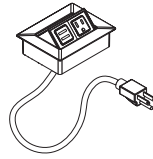

X No Power/USB Module
G55KRPL Left Front as Seated (\$406 upcharge)
G55KRPR Right Front as Seated (\$406 upcharge)
G55KRPLR Left and Right Front (\$812 upcharge)

TO ORDER, SPECIFY:

1. Model Number
2. Back Fabric Grade
3. Back Fabric Number
4. Seat Fabric Grade
5. Seat Fabric Number
6. Arm Fabric Grade
7. Arm Fabric Number
8. Wood Arm Cap Price Group (if applicable)
9. Arm Cap Finish Designator (if applicable)
10. Power/USB Module
11. Casters
12. Handle
13. Leg Option

- See pages 685-686 for Villa Health options
- See page 696 for COM fabric yardage

MOBILE LOUNGE CHAIR

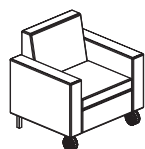

No Arm Caps

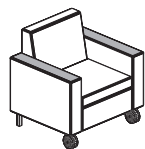

Arm Caps

MODEL NO.

ALLIANCE PROGRAM PRICE GRADES

			A	B	C	D	E	F	G	H	I
			J	K	L	M	N	O	P	Q	R
K6015ACOM	No Arm Caps	\$	2651	2810	2934	3057	3188	3341	3436	3601	3742
			3890	4126	4598	4893	4958	5011	5088	5158	5483
K6015ACOACWM	Wood Arm Caps		3054	3213	3337	3460	3591	3744	3839	4004	4145
			4293	4529	5001	5296	5361	5414	5491	5561	5886
K6015ACOACTM	3D Laminate Arm Caps		3055	3214	3338	3461	3592	3745	3840	4005	4146
			4294	4530	5002	5297	5362	5415	5492	5562	5887
K6015ACOACSM	Solid Surface Arm Caps		3330	3489	3613	3736	3867	4020	4115	4280	4421
			4569	4805	5277	5572	5637	5690	5767	5837	6162

DIMENSIONS

Width	35	Seat Height	18¾	Arm Height		Weight	61
Depth	29	Seat Depth	21½	No Arm Caps	26%	Cubic Ft.	28.70
Height	35¼	Seat Width	24¾	Arm Caps	27%		

- Clean out
- 123mm dual wheel casters on front: black
- Non-skid, adjustable glides on back legs
- Rounded handle on back: platinum metallic finish

VILLA HEALTH

TO ORDER, SPECIFY:

1. Model Number
2. Back Fabric Grade
3. Back Fabric Number
4. Seat Fabric Grade
5. Seat Fabric Number
6. Arm Fabric Grade
7. Arm Fabric Number
8. Wood Arm Cap Price Group (if applicable)
9. Tablet Arm Finish Designator
10. Tablet Arm Location
11. Power/USB Module
12. Casters
13. Handle
14. Leg Option

- See pages 685-686 for Villa Health options
- See page 696 for COM fabric yardage

MOBILE LOUNGE CHAIR WITH TABLET ARM



Tablet Arm
 Note: Illustration above shows power/USB grommet and non-handed tablet arm grommet options

MODEL NO.

ALLIANCE PROGRAM PRICE GRADES

			A	B	C	D	E	F	G	H	I
			J	K	L	M	N	O	P	Q	R
K6015ACOTLM	HPL Tablet Arm	\$	3041	3200	3324	3447	3578	3731	3826	3991	4132
			4280	4516	4988	5283	5348	5401	5478	5548	5873
K6015ACOTWM	Wood Tablet Arm		3071	3230	3354	3477	3608	3761	3856	4021	4162
			4310	4546	5018	5313	5378	5431	5508	5578	5903

DIMENSIONS

Width	35	Seat Height	18¾	Arm Height	26¾	Weight	69
Depth	29	Seat Depth	21¾			Cubic Ft.	28.70
Height	35¾	Seat Width	24¾				

- Clean out
- 123mm dual wheel casters on front: black
- Non-skid, adjustable glides on back legs
- Rounded handle on back: platinum metallic finish
- Tablet arm location may be specified as: L (left as seated); R (right as seated); or NH (non-handed for a \$31 upcharge)

TO ORDER, SPECIFY:

1. Model Number
2. Back Fabric Grade
3. Back Fabric Number
4. Seat Fabric Grade
5. Seat Fabric Number
6. Arm Fabric Grade
7. Arm Fabric Number
8. Wood Arm Cap Price Group (if applicable)
9. Arm Cap Finish Designator (if applicable)
10. Power/USB Module
11. Leg Option

- See pages 685-686 for Villa Health options
- See page 696 for COM fabric yardage

LOUNGE CHAIR

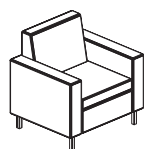

No Arm Caps

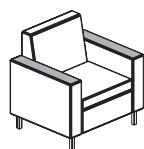

Arm Caps

MODEL NO.

ALLIANCE PROGRAM PRICE GRADES

		A	B	C	D	E	F	G	H	I
		J	K	L	M	N	O	P	Q	R
K6015ACO	No Arm Caps	\$ 2472	2631	2755	2878	3009	3162	3257	3422	3563
		3711	3947	4419	4714	4779	4832	4909	4979	5304
K6015ACOACW	Wood Arm Caps	2873	3032	3156	3279	3410	3563	3658	3823	3964
		4112	4348	4820	5115	5180	5233	5310	5380	5705
K6015ACOACT	3D Laminate Arm Caps	2873	3032	3156	3279	3410	3563	3658	3823	3964
		4112	4348	4820	5115	5180	5233	5310	5380	5705
K6015ACOACS	Solid Surface Arm Caps	3150	3309	3433	3556	3687	3840	3935	4100	4241
		4389	4625	5097	5392	5457	5510	5587	5657	5982

DIMENSIONS

Width	35	Seat Height	18¾	Arm Height		Weight	61
Depth	29	Seat Depth	21½	No Arm Caps	26%	Cubic Ft.	28.70
Height	35¼	Seat Width	24¾	Arm Caps	27%		

- Clean out
- Non-skid, adjustable glides on legs

VILLA HEALTH

TO ORDER, SPECIFY:

1. Model Number
2. Back Fabric Grade
3. Back Fabric Number
4. Seat Fabric Grade
5. Seat Fabric Number
6. Arm Fabric Grade
7. Arm Fabric Number
8. Wood or HPL Price Group
9. Tablet Arm Finish Designator
10. Tablet Arm Location
11. Power/USB Module
12. Leg Option

- See pages 685-686 for Villa Health options
- See page 696 for COM fabric yardage

LOUNGE CHAIR WITH TABLET ARM

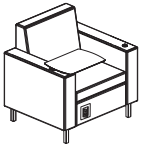

Tablet Arm
Note: Illustration above shows power/USB grommet (on the right as seated) and non-handed tablet arm grommet options

MODEL NO.

ALLIANCE PROGRAM PRICE GRADES

			A	B	C	D	E	F	G	H	I
			J	K	L	M	N	O	P	Q	R
K6015ACOTL	HPL Tablet Arm	\$	2861	3020	3144	3267	3398	3551	3646	3811	3952
			4100	4336	4808	5103	5168	5221	5298	5368	5693
K6015ACOTW	Wood Tablet Arm		2891	3050	3174	3297	3428	3581	3676	3841	3982
			4130	4366	4838	5133	5198	5251	5328	5398	5723

DIMENSIONS

Width	35	Seat Height	18¾	Arm Height	26¾	Weight	69
Depth	29	Seat Depth	21¾			Cubic Ft.	28.70
Height	35¾	Seat Width	24¾				

- Clean out
- Non-skid, adjustable glides on back legs
- Tablet arm location may be specified as: L (left as seated); R (right as seated); or NH (non-handed for a \$31 upcharge)

TO ORDER, SPECIFY:

1. Model Number
2. Back Fabric Grade
3. Back Fabric Number
4. Seat Fabric Grade
5. Seat Fabric Number
6. Arm Fabric Grade
7. Arm Fabric Number
8. Wood Arm Cap Price Group (if applicable)
9. Arm Cap Finish Designator (if applicable)
10. Power/USB Module
11. Leg Option

- See pages 685-686 for Villa Health options
- See page 696 for COM fabric yardage

LOVESEAT

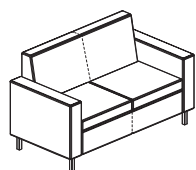

No Arm Caps

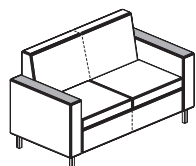

Arm Caps

MODEL NO.

ALLIANCE PROGRAM PRICE GRADES

		A	B	C	D	E	F	G	H	I
		J	K	L	M	N	O	P	Q	R
K6025ACO	No Arm Caps	\$ 3271	3472	3626	3782	3946	4138	4256	4464	4640
		4825	5121	5713	6083	6166	6231	6328	6416	6823
K6025ACOACW	Wood Arm Caps	3673	3874	4028	4184	4348	4540	4658	4866	5042
		5227	5523	6115	6485	6568	6633	6730	6818	7225
K6025ACOACT	3D Laminate Arm Caps	3674	3875	4029	4185	4349	4541	4659	4867	5043
		5228	5524	6116	6486	6569	6634	6731	6819	7226
K6025ACOACS	Solid Surface Arm Caps	3947	4148	4302	4458	4622	4814	4932	5140	5316
		5501	5797	6389	6759	6842	6907	7004	7092	7499

DIMENSIONS

Width	58¾	Seat Height	18¾	Arm Height		Weight	83.9
Depth	29	Seat Depth	21½	No Arm Caps	26%	Cubic Ft.	37.40
Height	35¼	Seat Width	48¾	Arm Caps	27%		

- Clean out
- Non-skid, adjustable glides on back legs

VILLA HEALTH

VILLA HEALTH

TO ORDER, SPECIFY:

1. Model Number
2. Back Fabric Grade
3. Back Fabric Number
4. Seat Fabric Grade
5. Seat Fabric Number
6. Arm Fabric Grade
7. Arm Fabric Number
8. Wood or HPL Price Group
9. Tablet Arm Finish Designator
10. Tablet Arm Location
11. Power/USB Module
12. Leg Option

- See pages 685-686 for Villa Health options
- See page 696 for COM fabric yardage

LOVESEAT WITH TABLET ARM

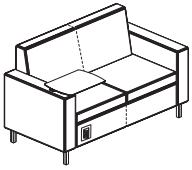

Tablet Arm
Note: Illustration above shows power/USB grommet option (on right as seated)

MODEL NO.

ALLIANCE PROGRAM PRICE GRADES

			A	B	C	D	E	F	G	H	I
			J	K	L	M	N	O	P	Q	R
K6025ACOTL	HPL Tablet Arm	\$	3663	3864	4018	4174	4338	4530	4648	4856	5032
			5217	5513	6105	6475	6558	6623	6720	6808	7215
K6025ACOTW	Wood Tablet Arm		3691	3892	4046	4202	4366	4558	4676	4884	5060
			5245	5541	6133	6503	6586	6651	6748	6836	7243

DIMENSIONS

Width	58¾	Seat Height	18¾	Arm Height	26¾	Weight	91.9
Depth	29	Seat Depth	21¾			Cubic Ft.	37.40
Height	35¾	Seat Width	48¾				

- Clean out
- Non-skid, adjustable glides on back legs
- Tablet arm location may be specified as: L (left as seated); R (right as seated); NH (non-handed for a \$31 upcharge) or LR (left and right as seated). A \$388 upcharge applies for laminate tablet and a \$416 upcharge applies for a wood tablet

TO ORDER, SPECIFY:

1. Model Number
2. Back Fabric Grade
3. Back Fabric Number
4. Seat Fabric Grade
5. Seat Fabric Number
6. Arm Fabric Grade
7. Arm Fabric Number
8. Wood Arm Cap Price Group (if applicable)
9. Arm Cap Finish Designator (if applicable)
10. Power/USB Module
11. Leg Option

- See pages 685-686 for Villa Health options
- See page 696 for COM fabric yardage

SOFA

MODEL NO.

ALLIANCE PROGRAM PRICE GRADES

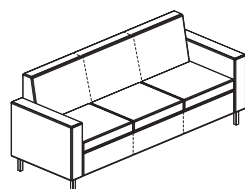

No Arm Caps

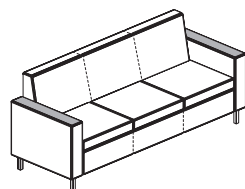

Arm Caps

MODEL NO.	Description	Price	A	B	C	D	E	F	G	H	I
			J	K	L	M	N	O	P	Q	R
K6035ACO	No Arm Caps	\$	4072	4312	4499	4686	4883	5113	5255	5506	5718
			5941	6297	7009	7454	7553	7632	7747	7854	8344
K6035ACOACW	Wood Arm Caps		4475	4715	4902	5089	5286	5516	5658	5909	6121
			6344	6700	7412	7857	7956	8035	8150	8257	8747
K6035ACOACT	3D Laminate Arm Caps		4475	4715	4902	5089	5286	5516	5658	5909	6121
			6344	6700	7412	7857	7956	8035	8150	8257	8747
K6035ACOACS	Solid Surface Arm Caps		4750	4990	5177	5364	5561	5791	5933	6184	6396
			6619	6975	7687	8132	8231	8310	8425	8532	9022

DIMENSIONS

Width	82¾	Seat Height	18¾	Arm Height		Weight	114.8
Depth	29	Seat Depth	21½	No Arm Caps	26%	Cubic Ft.	64.60
Height	35¼	Seat Width	72¼	Arm Caps	27%		

- Clean out
- Non-skid, adjustable glides on back legs

VILLA HEALTH

TO ORDER, SPECIFY:

1. Model Number
2. Back Fabric Grade
3. Back Fabric Number
4. Seat Fabric Grade
5. Seat Fabric Number
6. Arm Fabric Grade
7. Arm Fabric Number
8. Wood or HPL Price Group
9. Tablet Arm Finish Designator
10. Tablet Arm Location
11. Power/USB Module
12. Leg Option

- See pages 685-686 for Villa Health options
- See page 696 for COM fabric yardage

SOFA WITH TABLET ARM

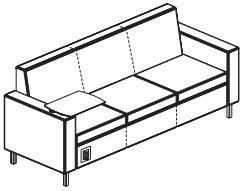

Tablet Arm
Note: Illustration at left shows power/USB grogram option (on right as seated)

MODEL NO.

ALLIANCE PROGRAM PRICE GRADES

			A	B	C	D	E	F	G	H	I
			J	K	L	M	N	O	P	Q	R
K6035ACOTL	HPL Tablet Arm	\$	4462	4702	4889	5076	5273	5503	5645	5896	6108
			6331	6687	7399	7844	7943	8022	8137	8244	8734
K6035ACOTW	Wood Tablet Arm		4491	4731	4918	5105	5302	5532	5674	5925	6137
			6360	6716	7428	7873	7972	8051	8166	8273	8763

DIMENSIONS

Width	82¼	Seat Height	18¾	Arm Height	26¾	Weight	122.8
Depth	29	Seat Depth	21¾			Cubic Ft.	64.60
Height	35½	Seat Width	72¼				

- Clean out
- Non-skid, adjustable glides on back legs
- Tablet arm location may be specified as: L (left as seated); R (right as seated); NH (non-handed for a \$31 upcharge) or LR (left and right as seated). A \$388 upcharge applies for laminate tablet and a \$416 upcharge applies for a wood tablet

TO ORDER, SPECIFY:

1. Model Number
2. Back Fabric Grade
3. Back Fabric Number
4. Seat Fabric Grade
5. Seat Fabric Number
6. Seat Cushion Firmness
7. Power/USB Module
8. Leg Option

- See pages 685-686 for Villa Health options
- See page 696 for COM fabric yardage

45° CRESCENT LOUNGE

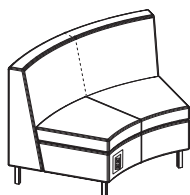

Note: Illustration above shows power/USB grommet option (on right as seated)

MODEL NO.

ALLIANCE PROGRAM PRICE GRADES

			A	B	C	D	E	F	G	H	I
			J	K	L	M	N	O	P	Q	R
K60CCCO	Crescent Lounge	\$	3261	3398	3505	3612	3725	3857	3939	4082	4204
			4332	4536	4944	5199	5255	5301	5367	5428	5709

DIMENSIONS

Width	53	Seat Height	18¾	Weight	112.5
Depth	32	Seat Depth	21¾	Cubic Ft.	51.30
Height	35¼	Seat Width	53		

- Clean out
- Non-skid, adjustable glides on back legs
- Seat cushion firmness - specify STD Standard cushion

COM YARDAGE REQUIREMENTS

COM YARDAGE REQUIREMENTS (54" WIDTH – CUT UP THE ROLL)

MODEL	RAILROADED Contact customer service 800-634-9510 for ydg requirements	NON DIRECTIONAL OR SOLID	1"-4" REPEAT	5"-11" REPEAT	12"-18" REPEAT	COL SQUARE FEET
			4" VERTICAL X 4" HORIZONTAL	11" VERTICAL X 11" HORIZONTAL	18" VERTICAL X 18" HORIZONTAL	
K6015ACOM, K6015ACOACWM, K6015ACOACTM, K6015ACOACSM	Entire Unit	4.70	6.00	7.80	8.80	91
	Back	1.80	1.90	2.10	3.10	33.3
	Base/Seat	1.40	1.50	2.70	3.70	25
	Arms	2.70	2.80	3.80	4.00	51.5
K6015ACOTLM, K6015ACOTWM	Entire Unit	4.70	6.00	7.80	8.80	91
	Back	1.80	1.90	2.10	3.10	33.3
	Base/Seat	1.40	1.50	2.70	3.70	25
	Arms	2.70	2.80	3.80	4.00	51.5
K6015ACO, K6015ACOACW, K6015ACOACT, K6015ACOACS	Entire Unit	4.70	6.00	7.80	8.80	91
	Back	1.80	1.90	2.10	3.10	33.3
	Base/Seat	1.40	1.50	2.70	3.70	25
	Arms	2.70	2.80	3.80	4.00	51.5
K6015ACOTL, K6015ACOTW	Entire Unit	4.70	6.00	7.80	8.80	91
	Back	1.80	1.90	2.10	3.10	33.3
	Base/Seat	1.40	1.50	2.70	3.70	25
	Arms	2.70	2.80	3.80	4.00	51.5
K6025ACO, K6025ACOACW, K6025ACOACT, K6025ACOACS	Entire Unit	5.90	9.10	11.80	12.30	117
	Back	2.60	4.70	5.50	5.50	62.5
	Base/Seat	2.10	3.00	4.50	6.20	40
	Arms	2.70	2.80	3.80	4.00	51.5
K6025ACOTL, K6025ACOTW	Entire Unit	5.90	9.10	11.80	12.30	117
	Back	2.60	4.70	5.50	5.50	62.5
	Base/Seat	2.10	3.00	4.50	6.20	40
	Arms	2.70	2.80	3.80	4.00	51.5
K6035ACO, K6035ACOACW, K6035ACOACT, K6035ACOACS	Entire Unit	7.70	12.30	15.20	17.20	151
	Back	3.30	5.20	5.80	7.10	63
	Base/Seat	2.90	4.30	6.30	8.70	57
	Arms	2.70	2.80	3.80	4.00	51.5
K6035ACOTL, K6035ACOTW	Entire Unit	7.70	12.30	15.20	17.20	151
	Back	3.30	5.20	5.80	7.10	63
	Base/Seat	2.90	4.30	6.30	8.70	57
	Arms	2.70	2.80	3.80	4.00	51.5
K60CCCO	Entire Unit	4.30	5.30	6.90	8.70	83.5
	Back	3.40	3.50	3.90	4.50	66.5
	Base/Seat	2.90	4.30	6.30	8.70	57