Whittaker Health

Product Specifications	774
Fabrics and Options	775
Contrasting Fabrics Specifications	776
Product Pages	777
COM Yardage Requirements	809

WHITTAKER HEALTH PRODUCT SPECIFICATIONS

FRAME CONSTRUCTION

- Lounge frame is constructed of $\frac{3}{8}$ " thick OSB, using a lap-joint construction method
- Frames are glued and screwed together
- Moisture barrier is optional for seat, or seat and inside back. Upcharge applies

HANDING DESIGNATION

- Handing designation (left or right of unit) is determined from the user's perspective when seated
- Unit shown is a left corner with convenience arm right

SEAT CONSTRUCTION

- Seats feature a high tension, strip webbing suspension that is stapled to the frame
- Seat upholstery features a wrap-around upholstery method and is stapled into place
- Clean out is standard to make cleaning easy and simple
- Cushions are made of high grade, high resiliency, CFC-free, laminated polyurethane foam
- Seat cushions are $3\frac{1}{4}$ " thick. Back cushions are $4\frac{1}{2}$ "

CONTRASTING FABRIC

- Contrasting fabric may be specified for inner back, outer back, seat, arm, and front panel/accent

ARM CAPS

- Arm caps are available as an option on convenience arms (upcharge applies)
- Available in polyurethane, 3D laminate, solid surface, or wood

ARMS

- Arms are available in convenience and full heights
- Arm frames are constructed of $\frac{1}{2}$ " thick plywood
- Arm tops and outside panels feature $\frac{1}{4}$ " thick, high grade polyurethane foam
- Arms feature a sewn slipcover with French seams that is stapled into place

LEGS

- Legs are 2mm tubular metal and available in several finishes

RAILS

- Side rails are 8mm bar stock
- Front and back rails are 6mm bar stock

POWER/USB MODULE

- Power/USB module is available and can be attached anywhere underneath the unit
- Specified separately for field installation
- Includes a 6' cord with three-prong plug, one power receptacle and two USB ports

GLIDES

- Non-skid, adjustable glides are $\frac{3}{4}$ " in diameter

GANGING BRACKETS

- Two ganging brackets (K82PGB) are required to join two units together
- Lounge models have pre-drilled holes in the base to accept the ganging bracket and small mating piece
- Once brackets are installed, units slide together for a secure connection
- To disconnect, lift up and pull outward on the unit with the smaller, mating pieces
- Assembly instructions available at: kimballhospitality.com

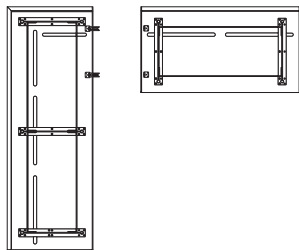
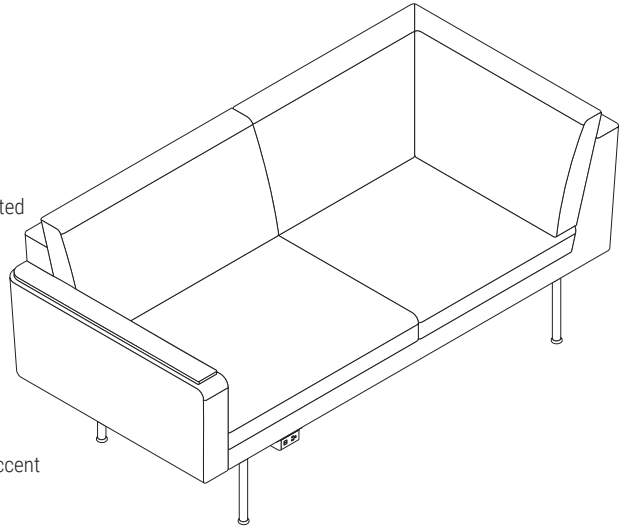

IMPORTANT: Applying upholsteries with horizontal or vertical patterns and stripes on corner units and the backs of units that will be used in a ganging application is discouraged

IMPORTANT: Fabrics reflect light differently when viewed at various angles, creating a natural phenomenon called "flip." Flip is visible on all fabrics and is not considered a defect; it is more easily recognized on fabrics with a nap or shimmer and more apparent on crescent or corner units

SURFACE MATERIALS

See the Kimball Hospitality Surface Materials Reference Guide at kimballhospitality.com for a complete overview of our materials program, including:

- Characteristics of wood
- Special wood finishes
- Customer specified laminate (CSL)
- Customer specified paint (CSP)
- Fabric application and colorways
- Customer's own material (COM) process overview
- Alliance program

ALLIANCE FABRIC PROGRAM

Kimball Hospitality has analyzed each model to most accurately reflect the COM/COL yardage requirements shown on page 809.

The yardage requirement for each model is based on 54" wide fabric and cutting the fabric up the roll.

If repeat is larger than 18", contact Customer Service to confirm the correct amount of yardage required. When ordering 10 or more chairs in the same COM, yardage requirements may be reduced.

Contact Customer Service.

PRICE GRADES A-R

See Surface Materials at www.kimballhospitality.com for a wide variety of graded-in fabrics from Arc-Com, Carnegie, CF Stinson, Designtex, Maharam, Mayer, Momentum, and Ultrafabrics.

FABRIC SAMPLES

If you need samples for presentation(s), contact our alliance partners directly at:

Arc-Com	800.223.5466	arc-com.com
Carnegie	800.727.6770	carnegiefabrics.com
CF Stinson	800.841.6279	cfstinson.com
Designtex	800.221.1540	designtex.com
Maharam	800.645.3943	maharam.com
Mayer	800.428.4415	mayerfabrics.com
Momentum	800.366.6839	memosamples.com
Ultrafabrics	877.309.6648	ultrafabricsllc.com

LEGS

PAINT

462	Cinder
405	Designer White

NON-PAINT*

490	Chrome
552	Gold
553	Rose Gold

*\$251 upcharge

MOISTURE BARRIER

X	No Moisture Barrier
MB1	Seat (\$140 upcharge)
MB2	Seat and Inside Back (\$245 upcharge)

ARM CAPS

WOOD FINISHES

PRICE GROUP 1

BZ	Brazilwood
CO	Canyon
CI	Chai
CC	Cordoba
DF	Driftwood
KN	Kona
MW	Midtown
MH	Mocha
YO	Monterey
PC	Porcini
PB	Portobello
792	Sable
NW	Tuscan
WL	Willow

IMPORTANT: Hardwood finishes on seating are complementary to veneer finishes on casegoods and tables, but may not be a direct match due to the difference in substrates

Contact Customer Service for more information

POLYURETHANE

SOLID

495	Beige
462	Cinder
495	Grey

3D LAMINATE

WOODGRAIN

CO	Canyon
DF	Driftwood
MH	Mocha
YO	Monterey
NW	Tuscan

SOLID SURFACE

STANDARD

7101	Bisque
405	Designer White

PREMIUM*

467	Carbon Concrete
468	Neutral Concrete
464	Peace Grey
469	Weathered Concrete

*\$446 upcharge

EOS*

495	EOS ^{CU} Beige
496	EOS ^{CU} Grey

*\$1206 upcharge

TO ORDER CONTRASTING FABRIC, SPECIFY

WHITTAKER HEALTH

One Seat, Two Seat, and Three Seat Armless Lounge Seating page 777

1. Model Number plus "X"
2. Inner Back Upholstery Grade
3. Inner Back Upholstery Number
4. Outer Back Upholstery Grade
5. Outer Back Upholstery Number
6. Seat Upholstery Grade
7. Seat Upholstery Number
8. Front Panel/Accent Upholstery Grade
9. Front Panel/Accent Upholstery Number
10. Leg Metal Finish Designator
11. Moisture Barrier Optional for Seat, or Seat and Inside Back

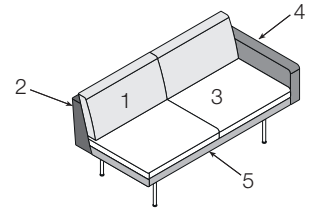

Contrasting fabric may be specified for inner back, outer back, seat, arm, and front panel/accent

One Seat and Two Seat Convenience Arm on Left Lounge page 778

Three Seat Convenience Arm on Left Lounge page 779

One Seat and Two Seat Convenience Arm on Right Lounge page 780

Three Seat Convenience Arm on Right Lounge page 781

One Seat and Two Seat Convenience Arm on Both Sides Lounge page 782

Three Seat Convenience Arm on Both Sides Lounge page 783

1. Model Number plus "X"
2. Inner Back Upholstery Grade
3. Inner Back Upholstery Number
4. Outer Back Upholstery Grade
5. Outer Back Upholstery Number
6. Seat Upholstery Grade
7. Seat Upholstery Number
8. Arm Upholstery Grade
9. Arm Upholstery Number
10. Front Panel/Accent Upholstery Grade
11. Front Panel/Accent Upholstery Number
12. Leg Metal Finish Designator
13. Arm Cap Finish or Color Designator (if applicable)
14. Moisture Barrier Optional for Seat, or Seat and Inside Back

One Seat and Two Seat Full Arm(s) Lounge page 784

Three Seat Full Arm(s) Lounge page 785

Two and Three Seat Interior Arms, No Side Arms Lounge page 786

1. Model Number plus "X"
2. Inner Back Upholstery Grade
3. Inner Back Upholstery Number
4. Outer Back Upholstery Grade
5. Outer Back Upholstery Number
6. Seat Upholstery Grade
7. Seat Upholstery Number
8. Arm Upholstery Grade
9. Arm Upholstery Number
10. Front Panel/Accent Upholstery Grade
11. Front Panel/Accent Upholstery Number
12. Leg Metal Finish Designator
13. Moisture Barrier Optional for Seat, or Seat and Inside Back

Two Seat Interior Arm in Center, Convenience Arm on Left Lounge page 787

Two Seat Interior Arm in Center, Convenience Arm on Right Lounge page 787

Two Seat Interior Arm in Center, Convenience Arm on Both Sides Lounge page 788

1. Model Number plus "X"
2. Inner Back Upholstery Grade
3. Inner Back Upholstery Number
4. Outer Back Upholstery Grade
5. Outer Back Upholstery Number
6. Seat Upholstery Grade
7. Seat Upholstery Number
8. Arm Upholstery Grade
9. Arm Upholstery Number
10. Front Panel/Accent Upholstery Grade
11. Front Panel/Accent Upholstery Number
12. Leg Metal Finish Designator
13. Arm Cap Finish or Color Designator (if applicable)
14. Moisture Barrier Optional for Seat, or Seat and Inside Back

TO ORDER, SPECIFY:

1. Model Number
2. Inner Back Upholstery Grade
3. Inner Back Upholstery Number
4. Outer Back Upholstery Grade
5. Outer Back Upholstery Number
6. Seat Upholstery Grade
7. Seat Upholstery Number
8. Front Panel/Accent Upholstery Grade
9. Front Panel/Accent Upholstery Number
10. Leg Metal Finish Designator
11. Moisture Barrier Optional for Seat, or Seat and Inside Back

- See page 775 for Whittaker Health options
- See pages 809-814 for COM fabric yardage

ARMLESS LOUNGE

MODEL NO.

ALLIANCE PROGRAM PRICE GRADES

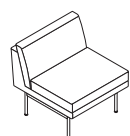

One Seat

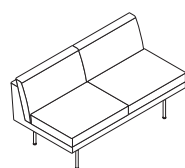

Two Seat

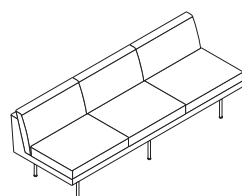

Three Seat

			A	B	C	D	E	F	G	H	I
			J	K	L	M	N	O	P	Q	R
K89L1XATB	One Seat	\$	2698	2823	2921	3019	3126	3251	3322	3458	3573
			3689	3879	4255	4493	4544	4592	4650	4705	4968
K89L2XATB	Two Seat		4204	4405	4562	4719	4888	5089	5203	5422	5605
			5793	6094	6697	7079	7162	7237	7331	7420	7840
K89L3XATB	Three Seat		5775	6070	6297	6527	6775	7068	7234	7554	7821
			8095	8535	9416	9975	10094	10204	10342	10470	11085

DIMENSIONS - ONE SEAT

Width	31¼	Seat Height	18½	Weight	75
Depth	29¼	Seat Depth	20½	Cubic Ft.	11.00
Height	29⅜	Seat Width	27¼		

DIMENSIONS - TWO SEAT

Width	55½	Seat Height	18½	Weight	125
Depth	29¼	Seat Depth	20½	Cubic Ft.	36.00
Height	29⅜	Seat Width	55½		

DIMENSIONS - THREE SEAT

Width	82½	Seat Height	18½	Weight	199
Depth	29¼	Seat Depth	20½	Cubic Ft.	53.00
Height	29⅜	Seat Width	82½		

- Contrasting fabric option – specify X (i.e., K89L3XATBX); see page 776. For list pricing, use your electronic specification tool or contact customer service
- Weight Limit 253 lbs.
- Tight-back
- Clean out
- 2mm tubular metal legs
- Non-skid, adjustable glides

WHITTAKER HEALTH

TO ORDER, SPECIFY:

1. Model Number
2. Inner Back Upholstery Grade
3. Inner Back Upholstery Number
4. Outer Back Upholstery Grade
5. Outer Back Upholstery Number
6. Seat Upholstery Grade
7. Seat Upholstery Number
8. Arm Upholstery Grade
9. Arm Upholstery Number
10. Front Panel/Accent Upholstery Grade
11. Front Panel/Accent Upholstery Number
12. Leg Metal Finish Designator
13. Arm Cap Finish or Color Designator (if applicable)
14. Moisture Barrier Optional for Seat, or Seat and Inside Back

- See page 775 for Whittaker Health options
- See pages 809-814 for COM fabric yardage

ONE SEAT CONVENIENCE ARM ON LEFT LOUNGE

MODEL NO.

ALLIANCE PROGRAM PRICE GRADES

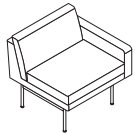

No Arm Cap

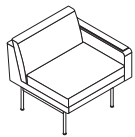

Arm Cap

			A	B	C	D	E	F	G	H	I
			J	K	L	M	N	O	P	Q	R
K89L1CVALUTB	No Arm Cap	\$	3242	3412	3546	3679	3825	3995	4092	4277	4433
			4592	4850	5362	5687	5757	5822	5901	5976	6334
K89L1CVALACWTB	Wood Arm Cap		3290	3460	3594	3727	3873	4043	4140	4325	4481
			4640	4898	5410	5735	5805	5870	5949	6024	6382
K89L1CVALACPTB	Polyurethane Arm Cap		3319	3489	3623	3756	3902	4072	4169	4354	4510
			4669	4927	5439	5764	5834	5899	5978	6053	6411
K89L1CVALACTTB	3D Laminate Arm Cap		3435	3605	3739	3872	4018	4188	4285	4470	4626
			4785	5043	5555	5880	5950	6015	6094	6169	6527
K89L1CVALACSTB	Solid Surface Arm Cap		3635	3805	3939	4072	4218	4388	4485	4670	4826
			4985	5243	5755	6080	6150	6215	6294	6369	6727

DIMENSIONS

Width	31 $\frac{1}{4}$	Seat Height	18 $\frac{1}{8}$	Arm Height		Weight	86
Depth	29 $\frac{3}{8}$	Seat Depth	20 $\frac{1}{8}$	No Arm Cap	22 $\frac{1}{8}$	Cubic Ft.	21.00
Height	29 $\frac{3}{16}$	Seat Width	27 $\frac{3}{8}$	Arm Cap	22 $\frac{1}{8}$		
				Arm Width	3 $\frac{1}{2}$		

- Contrasting fabric option – specify X (i.e., K89L1CVALUTBX); see page 776. For list pricing, use your electronic specification tool or contact customer service
- Weight Limit 253 lbs.
- Tight-back
- Clean out
- 2mm tubular metal legs
- Non-skid, adjustable glides
- Arm cap on applicable models

TWO SEAT CONVENIENCE ARM ON LEFT LOUNGE

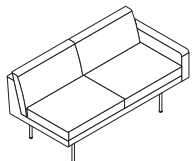

No Arm Cap

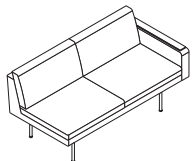

Arm Cap

			A	B	C	D	E	F	G	H	I
			J	K	L	M	N	O	P	Q	R
K89L2CVALUTB	No Arm Cap	\$	4717	4959	5148	5337	5541	5783	5920	6184	6404
			6630	6993	7719	8179	8278	8369	8482	8589	9095
K89L2CVALACWTB	Wood Arm Cap		4768	5010	5199	5388	5592	5834	5971	6235	6455
			6681	7044	7770	8230	8329	8420	8533	8640	9146
K89L2CVALACPTB	Polyurethane Arm Cap		4798	5040	5229	5418	5622	5864	6001	6265	6485
			6711	7074	7800	8260	8359	8450	8563	8670	9176
K89L2CVALACTTB	3D Laminate Arm Cap		4914	5156	5345	5534	5738	5980	6117	6381	6601
			6827	7190	7916	8376	8475	8566	8679	8786	9292
K89L2CVALACSTB	Solid Surface Arm Cap		5119	5361	5550	5739	5943	6185	6322	6586	6806
			7032	7395	8121	8581	8680	8771	8884	8991	9497

DIMENSIONS

Width	58 $\frac{1}{2}$	Seat Height	18 $\frac{1}{8}$	Arm Height		Weight	133
Depth	29 $\frac{3}{8}$	Seat Depth	20 $\frac{1}{8}$	No Arm Cap	22 $\frac{1}{8}$	Cubic Ft.	38.00
Height	29 $\frac{3}{16}$	Seat Width	55 $\frac{1}{8}$	Arm Cap	22 $\frac{1}{8}$		
				Arm Width	3 $\frac{1}{2}$		

- Contrasting fabric option – specify X (i.e., K89L2CVALUTBX); see page 776. For list pricing, use your electronic specification tool or contact customer service
- Weight Limit 253 lbs.
- Tight-back
- Clean out
- 2mm tubular metal legs
- Non-skid, adjustable glides
- Arm cap on applicable models

TO ORDER, SPECIFY:

1. Model Number
2. Inner Back Upholstery Grade
3. Inner Back Upholstery Number
4. Outer Back Upholstery Grade
5. Outer Back Upholstery Number
6. Seat Upholstery Grade
7. Seat Upholstery Number
8. Arm Upholstery Grade
9. Arm Upholstery Number
10. Front Panel/Accent Upholstery Grade
11. Front Panel/Accent Upholstery Number
12. Leg Metal Finish Designator
13. Arm Cap Finish or Color Designator (if applicable)
14. Moisture Barrier Optional for Seat, or Seat and Inside Back

- See page 775 for Whittaker Health options
- See pages 809-814 for COM fabric yardage

**THREE SEAT CONVENIENCE
ARM ON LEFT LOUNGE**

**MODEL
NO.**

ALLIANCE PROGRAM PRICE GRADES

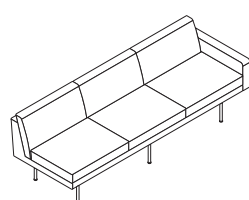

No Arm Cap

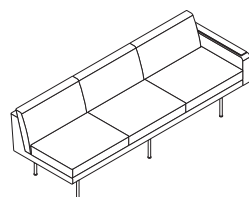

Arm Cap

MODEL NO.	Description	Price	A	B	C	D	E	F	G	H	I
			J	K	L	M	N	O	P	Q	R
K89L3CVALUTB	No Arm Cap	\$	6235	6551	6796	7043	7309	7622	7801	8144	8429
			8725	9197	10142	10741	10870	10988	11136	11274	11933
K89L3CVALACWTB	Wood Arm Cap		6285	6601	6846	7093	7359	7672	7851	8194	8479
			8775	9247	10192	10791	10920	11038	11186	11324	11983
K89L3CVALACPTB	Polyurethane Arm Cap		6315	6631	6876	7123	7389	7702	7881	8224	8509
			8805	9277	10222	10821	10950	11068	11216	11354	12013
K89L3CVALACTTB	3D Laminate Arm Cap		6430	6746	6991	7238	7504	7817	7996	8339	8624
			8920	9392	10337	10936	11065	11183	11331	11469	12128
K89L3CVALACSTB	Solid Surface Arm Cap		6636	6952	7197	7444	7710	8023	8202	8545	8830
			9126	9598	10543	11142	11271	11389	11537	11675	12334

DIMENSIONS

Width	86	Seat Height	18 $\frac{1}{2}$	Arm Height		Weight	206
Depth	29 $\frac{3}{4}$	Seat Depth	20 $\frac{1}{4}$	No Arm Cap	22 $\frac{3}{4}$	Cubic Ft.	56.00
Height	29 $\frac{3}{16}$	Seat Width	82 $\frac{1}{2}$	Arm Cap	22 $\frac{1}{4}$		
				Arm Width	3 $\frac{1}{2}$		

- Contrasting fabric option – specify X (i.e., K89L3CVALUTBX); see page 776. For list pricing, use your electronic specification tool or contact customer service
- Weight Limit 253 lbs.
- Tight-back
- Clean out
- 2mm tubular metal legs
- Non-skid, adjustable glides
- Arm cap on applicable models

WHITTAKER HEALTH

TO ORDER, SPECIFY:

1. Model Number
2. Inner Back Upholstery Grade
3. Inner Back Upholstery Number
4. Outer Back Upholstery Grade
5. Outer Back Upholstery Number
6. Seat Upholstery Grade
7. Seat Upholstery Number
8. Arm Upholstery Grade
9. Arm Upholstery Number
10. Front Panel/Accent Upholstery Grade
11. Front Panel/Accent Upholstery Number
12. Leg Metal Finish Designator
13. Arm Cap Finish or Color Designator (if applicable)
14. Moisture Barrier Optional for Seat, or Seat and Inside Back

- See page 775 for Whittaker Health options
- See pages 809-814 for COM fabric yardage

ONE SEAT CONVENIENCE ARM ON RIGHT LOUNGE

MODEL NO.

ALLIANCE PROGRAM PRICE GRADES

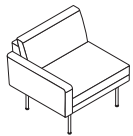

No Arm Cap

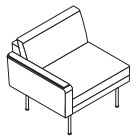

Arm Cap

			A	B	C	D	E	F	G	H	I
			J	K	L	M	N	O	P	Q	R
K89L1CVARUTB	No Arm Cap	\$	3242	3412	3546	3679	3825	3995	4092	4277	4433
			4592	4850	5362	5687	5757	5822	5901	5976	6334
K89L1CVARACWTB	Wood Arm Cap		3290	3460	3594	3727	3873	4043	4140	4325	4481
			4640	4898	5410	5735	5805	5870	5949	6024	6382
K89L1CVARACPTB	Polyurethane Arm Cap		3319	3489	3623	3756	3902	4072	4169	4354	4510
			4669	4927	5439	5764	5834	5899	5978	6053	6411
K89L1CVARACTTB	3D Laminate Arm Cap		3435	3605	3739	3872	4018	4188	4285	4470	4626
			4785	5043	5555	5880	5950	6015	6094	6169	6527
K89L1CVARACSTB	Solid Surface Arm Cap		3635	3805	3939	4072	4218	4388	4485	4670	4826
			4985	5243	5755	6080	6150	6215	6294	6369	6727

DIMENSIONS

Width	31 $\frac{1}{4}$	Seat Height	18 $\frac{1}{8}$	Arm Height		Weight	86
Depth	29 $\frac{3}{4}$	Seat Depth	20 $\frac{1}{16}$	No Arm Cap	22 $\frac{3}{16}$	Cubic Ft.	21.00
Height	29 $\frac{9}{16}$	Seat Width	27 $\frac{3}{4}$	Arm Cap	22 $\frac{1}{16}$		
				Arm Width	3 $\frac{1}{2}$		

- Contrasting fabric option – specify X (i.e., K89L1CVARUTBX); see page 776. For list pricing, use your electronic specification tool or contact customer service
- Weight Limit 253 lbs.
- Tight-back
- Clean out
- 2mm tubular metal legs
- Non-skid, adjustable glides
- Arm cap on applicable models

TWO SEAT CONVENIENCE ARM ON RIGHT LOUNGE

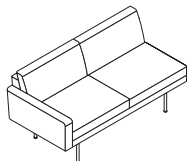

No Arm Cap

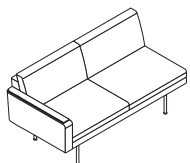

Arm Cap

			A	B	C	D	E	F	G	H	I
			J	K	L	M	N	O	P	Q	R
K89L2CVARUTB	No Arm Cap	\$	4717	4959	5148	5337	5541	5783	5920	6184	6404
			6630	6993	7719	8179	8278	8369	8482	8589	9095
K89L2CVARACWTB	Wood Arm Cap		4768	5010	5199	5388	5592	5834	5971	6235	6455
			6681	7044	7770	8230	8329	8420	8533	8640	9146
K89L2CVARACPTB	Polyurethane Arm Cap		4798	5040	5229	5418	5622	5864	6001	6265	6485
			6711	7074	7800	8260	8359	8450	8563	8670	9176
K89L2CVARACTTB	3D Laminate Arm Cap		4914	5156	5345	5534	5738	5980	6117	6381	6601
			6827	7190	7916	8376	8475	8566	8679	8786	9292
K89L2CVARACSTB	Solid Surface Arm Cap		5119	5361	5550	5739	5943	6185	6322	6586	6806
			7032	7395	8121	8581	8680	8771	8884	8991	9497

DIMENSIONS

Width	58 $\frac{1}{2}$	Seat Height	18 $\frac{1}{8}$	Arm Height		Weight	133
Depth	29 $\frac{3}{4}$	Seat Depth	20 $\frac{1}{16}$	No Arm Cap	22 $\frac{3}{16}$	Cubic Ft.	38.00
Height	29 $\frac{9}{16}$	Seat Width	55 $\frac{1}{8}$	Arm Cap	22 $\frac{1}{16}$		
				Arm Width	3 $\frac{1}{2}$		

- Contrasting fabric option – specify X (i.e., K89L2CVARUTBX); see page 776. For list pricing, use your electronic specification tool or contact customer service
- Weight Limit 253 lbs.
- Tight-back
- Clean out
- 2mm tubular metal legs
- Non-skid, adjustable glides
- Arm cap on applicable models

TO ORDER, SPECIFY:

1. Model Number
2. Inner Back Upholstery Grade
3. Inner Back Upholstery Number
4. Outer Back Upholstery Grade
5. Outer Back Upholstery Number
6. Seat Upholstery Grade
7. Seat Upholstery Number
8. Arm Upholstery Grade
9. Arm Upholstery Number
10. Front Panel/Accent Upholstery Grade
11. Front Panel/Accent Upholstery Number
12. Leg Metal Finish Designator
13. Arm Cap Finish or Color Designator (if applicable)
14. Moisture Barrier Optional for Seat, or Seat and Inside Back

- See page 775 for Whittaker Health options
- See pages 809-814 for COM fabric yardage

**THREE SEAT CONVENIENCE
ARM ON RIGHT LOUNGE**

**MODEL
NO.**

ALLIANCE PROGRAM PRICE GRADES

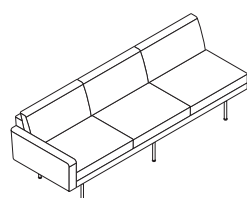

No Arm Cap

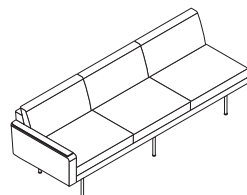

Arm Cap

MODEL NO.	Description	Price	A	B	C	D	E	F	G	H	I
			J	K	L	M	N	O	P	Q	R
K89L3CVARUTB	No Arm Cap	\$	6235	6551	6796	7043	7309	7622	7801	8144	8429
			8725	9197	10142	10741	10870	10988	11136	11274	11933
K89L3CVARACWTB	Wood Arm Cap		6285	6601	6846	7093	7359	7672	7851	8194	8479
			8775	9247	10192	10791	10920	11038	11186	11324	11983
K89L3CVARACPTB	Polyurethane Arm Cap		6315	6631	6876	7123	7389	7702	7881	8224	8509
			8805	9277	10222	10821	10950	11068	11216	11354	12013
K89L3CVARACTTB	3D Laminate Arm Cap		6430	6746	6991	7238	7504	7817	7996	8339	8624
			8920	9392	10337	10936	11065	11183	11331	11469	12128
K89L3CVARACSTB	Solid Surface Arm Cap		6636	6952	7197	7444	7710	8023	8202	8545	8830
			9126	9598	10543	11142	11271	11389	11537	11675	12334

DIMENSIONS

Width	86	Seat Height	18 $\frac{1}{2}$	Arm Height		Weight	206
Depth	29 $\frac{3}{4}$	Seat Depth	20 $\frac{1}{4}$	No Arm Cap	22 $\frac{3}{4}$	Cubic Ft.	56.00
Height	29 $\frac{3}{16}$	Seat Width	82 $\frac{1}{2}$	Arm Cap	22 $\frac{1}{4}$		
				Arm Width	3 $\frac{1}{2}$		

- Contrasting fabric option – specify X (i.e., K89L3CVARUTBX); see page 776. For list pricing, use your electronic specification tool or contact customer service
- Weight Limit 253 lbs.
- Tight-back
- Clean out
- 2mm tubular metal legs
- Non-skid, adjustable glides
- Arm cap on applicable models

WHITTAKER HEALTH

TO ORDER, SPECIFY:

1. Model Number
2. Inner Back Upholstery Grade
3. Inner Back Upholstery Number
4. Outer Back Upholstery Grade
5. Outer Back Upholstery Number
6. Seat Upholstery Grade
7. Seat Upholstery Number
8. Arm Upholstery Grade
9. Arm Upholstery Number
10. Front Panel/Accent Upholstery Grade
11. Front Panel/Accent Upholstery Number
12. Leg Metal Finish Designator
13. Arm Cap Finish or Color Designator (if applicable)
14. Moisture Barrier Optional for Seat, or Seat and Inside Back

- See page 775 for Whittaker Health options
- See pages 809-814 for COM fabric yardage

ONE SEAT CONVENIENCE ARM ON BOTH SIDES LOUNGE

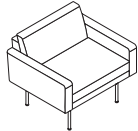

No Arm Caps

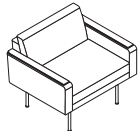

Arm Caps

MODEL NO.

ALLIANCE PROGRAM PRICE GRADES

			A	B	C	D	E	F	G	H	I
			J	K	L	M	N	O	P	Q	R
K89L1CVABUTB	No Arm Cap	\$	3567	3741	3877	4013	4162	4336	4434	4624	4783
			4945	5209	5731	6063	6134	6200	6281	6357	6723
K89L1CVABACWTB	Wood Arm Cap		3642	3816	3952	4088	4237	4411	4509	4699	4858
			5020	5284	5806	6138	6209	6275	6356	6432	6798
K89L1CVABACPTB	Polyurethane Arm Cap		3717	3891	4027	4163	4312	4486	4584	4774	4933
			5095	5359	5881	6213	6284	6350	6431	6507	6873
K89L1CVABACTTB	3D Laminate Arm Cap		3948	4122	4258	4394	4543	4717	4815	5005	5164
			5326	5590	6112	6444	6515	6581	6662	6738	7104
K89L1CVABACSTB	Solid Surface Arm Cap		4357	4531	4667	4803	4952	5126	5224	5414	5573
			5735	5999	6521	6853	6924	6990	7071	7147	7513

DIMENSIONS

Width	34 $\frac{3}{4}$	Seat Height	18 $\frac{1}{2}$	Arm Height		Weight	94
Depth	29 $\frac{3}{4}$	Seat Depth	20 $\frac{1}{4}$	No Arm Cap	22 $\frac{1}{4}$	Cubic Ft.	23.00
Height	29 $\frac{3}{16}$	Seat Width	27 $\frac{3}{4}$	Arm Cap	22 $\frac{1}{4}$		
				Arm Width	3 $\frac{1}{2}$		

- Contrasting fabric option – specify X (i.e., K89L1CVABUTBX); see page 776. For list pricing, use your electronic specification tool or contact customer service
- Weight Limit 253 lbs.
- Tight-back
- Clean out
- 2mm tubular metal legs
- Non-skid, adjustable glides
- Arm cap on applicable models

TWO SEAT CONVENIENCE ARM ON BOTH SIDES LOUNGE

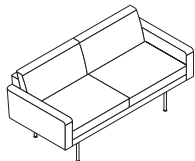

No Arm Caps

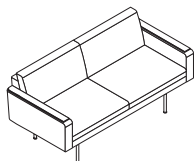

Arm Caps

			A	B	C	D	E	F	G	H	I
			J	K	L	M	N	O	P	Q	R
K89L2CVABUTB	No Arm Cap	\$	5050	5300	5495	5690	5901	6151	6292	6565	6792
			7026	7401	8150	8626	8729	8822	8939	9049	9572
K89L2CVABACWTB	Wood Arm Cap		5153	5403	5598	5793	6004	6254	6395	6668	6895
			7129	7504	8253	8729	8832	8925	9042	9152	9675
K89L2CVABACPTB	Polyurethane Arm Cap		5211	5461	5656	5851	6062	6312	6453	6726	6953
			7187	7562	8311	8787	8890	8983	9100	9210	9733
K89L2CVABACTTB	3D Laminate Arm Cap		5439	5689	5884	6079	6290	6540	6681	6954	7181
			7415	7790	8539	9015	9118	9211	9328	9438	9961
K89L2CVABACSTB	Solid Surface Arm Cap		5850	6100	6295	6490	6701	6951	7092	7365	7592
			7826	8201	8950	9426	9529	9622	9739	9849	10372

DIMENSIONS

Width	62 $\frac{1}{2}$	Seat Height	18 $\frac{1}{2}$	Arm Height		Weight	141
Depth	29 $\frac{3}{4}$	Seat Depth	20 $\frac{1}{4}$	No Arm Cap	22 $\frac{1}{4}$	Cubic Ft.	41.00
Height	29 $\frac{3}{16}$	Seat Width	55 $\frac{1}{2}$	Arm Cap	22 $\frac{1}{4}$		
				Arm Width	3 $\frac{1}{2}$		

- Contrasting fabric option – specify X (i.e., K89L2CVABUTBX); see page 776. For list pricing, use your electronic specification tool or contact customer service
- Weight Limit 253 lbs.
- Tight-back
- Clean out
- 2mm tubular metal legs
- Non-skid, adjustable glides
- Arm cap on applicable models

TO ORDER, SPECIFY:

1. Model Number
2. Inner Back Upholstery Grade
3. Inner Back Upholstery Number
4. Outer Back Upholstery Grade
5. Outer Back Upholstery Number
6. Seat Upholstery Grade
7. Seat Upholstery Number
8. Arm Upholstery Grade
9. Arm Upholstery Number
10. Front Panel/Accent Upholstery Grade
11. Front Panel/Accent Upholstery Number
12. Leg Metal Finish Designator
13. Arm Cap Finish or Color Designator (if applicable)
14. Moisture Barrier Optional for Seat, or Seat and Inside Back

- See page 775 for Whittaker Health options
- See pages 809-814 for COM fabric yardage

**THREE SEAT CONVENIENCE
ARM ON BOTH SIDES
LOUNGE**

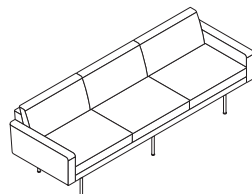

No Arm Caps

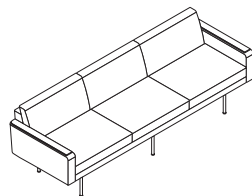

Arm Caps

**MODEL
NO.**

ALLIANCE PROGRAM PRICE GRADES

			A	B	C	D	E	F	G	H	I
			J	K	L	M	N	O	P	Q	R
K89L3CVABUTB	No Arm Cap	\$	6562	6886	7137	7390	7663	7984	8167	8519	8811
			9115	9599	10567	11182	11315	11435	11587	11728	12404
K89L3CVABACWTB	Wood Arm Cap		6663	6987	7238	7491	7764	8085	8268	8620	8912
			9216	9700	10668	11283	11416	11536	11688	11829	12505
K89L3CVABACPTB	Polyurethane Arm Cap		6724	7048	7299	7552	7825	8146	8329	8681	8973
			9277	9761	10729	11344	11477	11597	11749	11890	12566
K89L3CVABACTTB	3D Laminate Arm Cap		6954	7278	7529	7782	8055	8376	8559	8911	9203
			9507	9991	10959	11574	11707	11827	11979	12120	12796
K89L3CVABACSTB	Solid Surface Arm Cap		7365	7689	7940	8193	8466	8787	8970	9322	9614
			9918	10402	11370	11985	12118	12238	12390	12531	13207

DIMENSIONS

Width	89½	Seat Height	18¾	Arm Height		Weight	214
Depth	29¾	Seat Depth	20¼	No Arm Cap	22¾	Cubic Ft.	58.00
Height	29¾	Seat Width	82½	Arm Cap	22¼		
				Arm Width	3½		

- Contrasting fabric option – specify X (i.e., K89L3CVABUTBX); see page 776. For list pricing, use your electronic specification tool or contact customer service
- Weight Limit 253 lbs.
- Tight-back
- Clean out
- 2mm tubular metal legs
- Non-skid, adjustable glides
- Arm cap on applicable models

TO ORDER, SPECIFY:

1. Model Number
2. Inner Back Upholstery Grade
3. Inner Back Upholstery Number
4. Outer Back Upholstery Grade
5. Outer Back Upholstery Number
6. Seat Upholstery Grade
7. Seat Upholstery Number
8. Arm Upholstery Grade
9. Arm Upholstery Number
10. Front Panel/Accent Upholstery Grade
11. Front Panel/Accent Upholstery Number
12. Leg Metal Finish Designator
13. Moisture Barrier Optional for Seat, or Seat and Inside Back

- See page 775 for Whittaker Health options
- See pages 809-814 for COM fabric yardage

ONE SEAT FULL ARM(S) LOUNGE

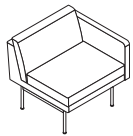

Full Arm on Left

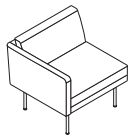

Full Arm on Right

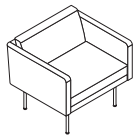

Full Arm on Both Sides

MODEL NO.

ALLIANCE PROGRAM PRICE GRADES

			A	B	C	D	E	F	G	H	I
			J	K	L	M	N	O	P	Q	R
K89L1FALTB	Full Arm on Left	\$	3248	3418	3552	3685	3831	4001	4098	4283	4439
			4598	4856	5368	5693	5763	5828	5907	5982	6340
K89L1FARTB	Full Arm on Right		3248	3418	3552	3685	3831	4001	4098	4283	4439
			4598	4856	5368	5693	5763	5828	5907	5982	6340
K89L1FABTB	Full Arm on Both Sides		3584	3776	3926	4076	4239	4431	4539	4748	4923
			5102	5391	5967	6332	6410	6483	6572	6656	7059

DIMENSIONS

Width	29¾	Seat Height	18¾	Arm Height	26¾	Weight	86
Depth	29¾	Seat Depth	20⅞	Arm Width	2	Weight Both Sides	93
Height	29⅜	Seat Width	27¾			Cubic Ft.	20.00
						Cubic Ft. Both Sides	22.00

- Contrasting fabric option – specify X (i.e., K89L1FALTBX); see page 776. For list pricing, use your electronic specification tool or contact customer service
- Weight Limit 253 lbs.
- Tight-back
- Clean out
- 2mm tubular metal legs
- Non-skid, adjustable glides

TWO SEAT FULL ARM(S) LOUNGE

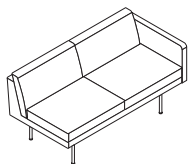

Full Arm on Left

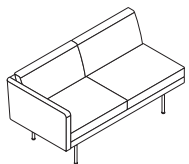

Full Arm on Right

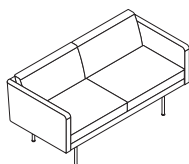

Full Arm on Both Sides

			A	B	C	D	E	F	G	H	I
			J	K	L	M	N	O	P	Q	R
K89L2FALTB	Full Arm on Left	\$	4743	4989	5182	5374	5582	5828	5968	6236	6460
			6691	7060	7799	8268	8370	8462	8577	8686	9201
K89L2FARTB	Full Arm on Right		4743	4989	5182	5374	5582	5828	5968	6236	6460
			6691	7060	7799	8268	8370	8462	8577	8686	9201
K89L2FABTB	Full Arm on Both Sides		5111	5379	5588	5797	6022	6290	6441	6733	6976
			7227	7627	8430	8939	9049	9149	9274	9392	9952

DIMENSIONS

Width	57¾	Seat Height	18¾	Arm Height	26¾	Weight	133
Depth	29¾	Seat Depth	20⅞	Arm Width	2	Weight Both Sides	140
Height	29⅜	Seat Width	55¾			Cubic Ft.	37.00
						Cubic Ft. Both Sides	39.00

- Contrasting fabric option – specify X (i.e., K89L2FALTBX); see page 776. For list pricing, use your electronic specification tool or contact customer service
- Weight Limit 253 lbs.
- Tight-back
- Clean out
- 2mm tubular metal legs
- Non-skid, adjustable glides

TO ORDER, SPECIFY:

1. Model Number
2. Inner Back Upholstery Grade
3. Inner Back Upholstery Number
4. Outer Back Upholstery Grade
5. Outer Back Upholstery Number
6. Seat Upholstery Grade
7. Seat Upholstery Number
8. Arm Upholstery Grade
9. Arm Upholstery Number
10. Front Panel/Accent Upholstery Grade
11. Front Panel/Accent Upholstery Number
12. Leg Metal Finish Designator
13. Moisture Barrier Optional for Seat, or Seat and Inside Back

- See page 775 for Whittaker Health options
- See pages 809-814 for COM fabric yardage

THREE SEAT FULL ARM(S) LOUNGE

MODEL NO.

ALLIANCE PROGRAM PRICE GRADES

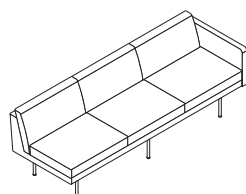

Full Arm on Left

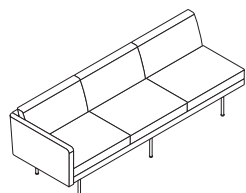

Full Arm on Right

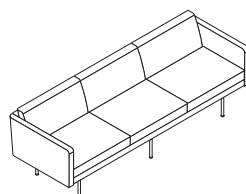

Full Arm on Both Sides

MODEL NO.	Description	Price	A	B	C	D	E	F	G	H	I
			J	K	L	M	N	O	P	Q	R
K89L3FALTB	Full Arm on Left	\$	6070	6390	6639	6889	7159	7476	7658	8005	8294
			8595	9073	10031	10639	10771	10890	11040	11180	11848
K89L3FARTB	Full Arm on Right		6070	6390	6639	6889	7159	7476	7658	8005	8294
			8595	9073	10031	10639	10771	10890	11040	11180	11848
K89L3FABTB	Full Arm on Both Sides		6120	6462	6727	6994	7281	7620	7813	8184	8492
			8813	9322	10344	10992	11132	11259	11419	11568	12281

DIMENSIONS

Width	84½	Seat Height	18½	Arm Height	26½	Weight	206
Depth	29¾	Seat Depth	20¾	Arm Width	2	Weight Both Sides	214
Height	29¾	Seat Width	82½			Cubic Ft.	55.00
						Cubic Ft. Both Sides	56.00

- Contrasting fabric option – specify X (i.e., K89L3FALTBX); see page 776. For list pricing, use your electronic specification tool or contact customer service
- Weight Limit 253 lbs.
- Tight-back
- Clean out
- 2mm tubular metal legs
- Non-skid, adjustable glides

WHITTAKER HEALTH

TO ORDER, SPECIFY:

1. Model Number
2. Inner Back Upholstery Grade
3. Inner Back Upholstery Number
4. Outer Back Upholstery Grade
5. Outer Back Upholstery Number
6. Seat Upholstery Grade
7. Seat Upholstery Number
8. Arm Upholstery Grade
9. Arm Upholstery Number
10. Front Panel/Accent Upholstery Grade
11. Front Panel/Accent Upholstery Number
12. Leg Metal Finish Designator
13. Moisture Barrier Optional for Seat, or Seat and Inside Back

- See page 775 for Whittaker Health options
- See pages 809-814 for COM fabric yardage

WHITTAKER HEALTH

TWO SEAT INTERIOR ARMS, NO SIDE ARMS LOUNGE

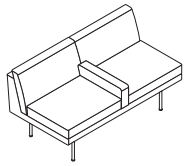

MODEL NO.

ALLIANCE PROGRAM PRICE GRADES

			A	B	C	D	E	F	G	H	I
			J	K	L	M	N	O	P	Q	R
K89L2XAITB	Interior Arm Center	\$	4154	4387	4569	4751	4948	5181	5312	5566	5778
			5996	6346	7044	7487	7583	7670	7779	7881	8369

DIMENSIONS

Width	55½	Seat Height	18½	Arm Height	26½	Weight	132
Depth	29¾	Seat Depth	20½	Arm Width	3½	Cubic Ft.	36.00
Height	29⅜	Seat Width	55½				

- Contrasting fabric option – specify X (i.e., K89L2XAITBX); see page 776. For list pricing, use your electronic specification tool or contact customer service
- Weight Limit 253 lbs.
- Tight-back
- Clean out
- 2mm tubular metal legs
- Non-skid, adjustable glides

THREE SEAT INTERIOR ARMS, NO SIDE ARMS LOUNGE

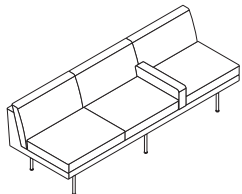

Interior Arm Left

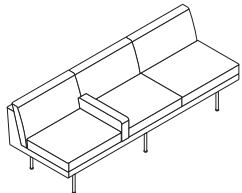

Interior Arm Right

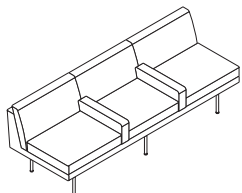

Interior Arms Left and Right

			A	B	C	D	E	F	G	H	I
			J	K	L	M	N	O	P	Q	R
K89L3XAILTB	Interior Arm Left	\$	5570	5884	6127	6373	6637	6948	7126	7466	7750
			8044	8513	9452	10047	10176	10293	10440	10577	11232
K89L3XAIRTB	Interior Arm Right		5570	5884	6127	6373	6637	6948	7126	7466	7750
			8044	8513	9452	10047	10176	10293	10440	10577	11232
K89L3XAIBTB	Interior Arms Left and Right		5578	5892	6135	6381	6645	6956	7134	7474	7758
			8052	8521	9460	10055	10184	10301	10448	10585	11240

DIMENSIONS

Width	82½	Seat Height	18½	Arm Height	26½	Weight	206
Depth	29¾	Seat Depth	20½	Arm Width	2	Weight Both Sides	213
Height	29⅜	Seat Width	82½			Cubic Ft.	53.00

- Contrasting fabric option – specify X (i.e., K89L3XAILTBX); see page 776. For list pricing, use your electronic specification tool or contact customer service
- Weight Limit 253 lbs.
- Tight-back
- Clean out
- 2mm tubular metal legs
- Non-skid, adjustable glides

TO ORDER, SPECIFY:

- 1. Model Number
- 2. Inner Back Upholstery Grade
- 3. Inner Back Upholstery Number
- 4. Outer Back Upholstery Grade
- 5. Outer Back Upholstery Number
- 6. Seat Upholstery Grade
- 7. Seat Upholstery Number
- 8. Arm Upholstery Grade
- 9. Arm Upholstery Number
- 10. Front Panel/Accent Upholstery Grade
- 11. Front Panel/Accent Upholstery Number
- 12. Leg Metal Finish Designator
- 13. Arm Cap Finish or Color Designator (if applicable)
- 14. Moisture Barrier Optional for Seat, or Seat and Inside Back

- See page 775 for Whittaker Health options
- See pages 809-814 for COM fabric yardage

TWO SEAT INTERIOR ARM IN CENTER, CONVENIENCE ARM ON LEFT LOUNGE

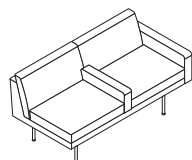

No Arm Caps

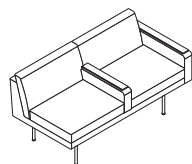

Arm Caps

MODEL NO.

ALLIANCE PROGRAM PRICE GRADES

			A	B	C	D	E	F	G	H	I
			J	K	L	M	N	O	P	Q	R
K89L2CVALIUTB	No Arm Caps	\$	4810	5056	5249	5441	5649	5895	6035	6303	6527
			6758	7127	7866	8335	8437	8529	8644	8753	9268
K89L2CVALIACWTB	Wood Arm Caps		4904	5150	5343	5535	5743	5989	6129	6397	6621
			6852	7221	7960	8429	8531	8623	8738	8847	9362
K89L2CVALIACPTB	Polyurethane Arm Caps		4972	5218	5411	5603	5811	6057	6197	6465	6689
			6920	7289	8028	8497	8599	8691	8806	8915	9430
K89L2CVALIACCTB	3D Laminate Arm Caps		5585	5831	6024	6216	6424	6670	6810	7078	7302
			7533	7902	8641	9110	9212	9304	9419	9528	10043
K89L2CVALIACSTB	Solid Surface Arm Caps		5812	6058	6251	6443	6651	6897	7037	7305	7529
			7760	8129	8868	9337	9439	9531	9646	9755	10270

DIMENSIONS

Width	58 $\frac{3}{4}$	Seat Height	18 $\frac{1}{2}$	Arm Height		Weight	140
Depth	29 $\frac{3}{4}$	Seat Depth	20 $\frac{3}{16}$	No Arm Cap	22 $\frac{3}{16}$	Cubic Ft.	38.00
Height	29 $\frac{13}{16}$	Seat Width	25 $\frac{13}{16}$	Arm Cap	22 $\frac{1}{16}$		
				Arm Width	3 $\frac{1}{2}$		

- Contrasting fabric option – specify X (i.e., K89L2CVALIUTBX); see page 776. For list pricing, use your electronic specification tool or contact customer service
- Weight Limit 253 lbs.
- Tight-back
- Clean out
- 2mm tubular metal legs
- Non-skid, adjustable glides
- Arm caps on applicable models

TWO SEAT INTERIOR ARM IN CENTER, CONVENIENCE ARM ON RIGHT LOUNGE

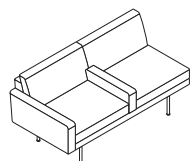

No Arm Caps

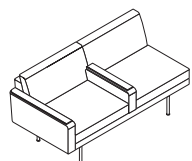

Arm Caps

			A	B	C	D	E	F	G	H	I
			J	K	L	M	N	O	P	Q	R
K89L2CVARIUTB	No Arm Caps	\$	4810	5056	5249	5441	5649	5895	6035	6303	6527
			6758	7127	7866	8335	8437	8529	8644	8753	9268
K89L2CVARIACWTB	Wood Arm Caps		4904	5150	5343	5535	5743	5989	6129	6397	6621
			6852	7221	7960	8429	8531	8623	8738	8847	9362
K89L2CVARIACPTB	Polyurethane Arm Caps		4972	5218	5411	5603	5811	6057	6197	6465	6689
			6920	7289	8028	8497	8599	8691	8806	8915	9430
K89L2CVARIACCTB	3D Laminate Arm Caps		5585	5831	6024	6216	6424	6670	6810	7078	7302
			7533	7902	8641	9110	9212	9304	9419	9528	10043
K89L2CVARIACSTB	Solid Surface Arm Caps		5812	6058	6251	6443	6651	6897	7037	7305	7529
			7760	8129	8868	9337	9439	9531	9646	9755	10270

DIMENSIONS

Width	58 $\frac{3}{4}$	Seat Height	18 $\frac{1}{2}$	Arm Height		Weight	140
Depth	29 $\frac{3}{4}$	Seat Depth	20 $\frac{3}{16}$	No Arm Cap	22 $\frac{3}{16}$	Cubic Ft.	38.00
Height	29 $\frac{13}{16}$	Seat Width	25 $\frac{13}{16}$	Arm Cap	22 $\frac{1}{16}$		
				Arm Width	3 $\frac{1}{2}$		

- Contrasting fabric option – specify X (i.e., K89L2CVARIUTBX); see page 776. For list pricing, use your electronic specification tool or contact customer service
- Weight Limit 253 lbs.
- Tight-back
- Clean out
- 2mm tubular metal legs
- Non-skid, adjustable glides
- Arm caps on applicable models

TO ORDER, SPECIFY:

1. Model Number
2. Inner Back Upholstery Grade
3. Inner Back Upholstery Number
4. Outer Back Upholstery Grade
5. Outer Back Upholstery Number
6. Seat Upholstery Grade
7. Seat Upholstery Number
8. Arm Upholstery Grade
9. Arm Upholstery Number
10. Front Panel/Accent Upholstery Grade
11. Front Panel/Accent Upholstery Number
12. Leg Metal Finish Designator
13. Arm Cap Finish or Color Designator (if applicable)
14. Moisture Barrier Optional for Seat, or Seat and Inside Back

- See page 775 for Whittaker Health options
- See pages 809-814 for COM fabric yardage

WHITTAKER HEALTH

TWO SEAT INTERIOR ARM IN CENTER, CONVENIENCE ARM ON BOTH SIDES LOUNGE

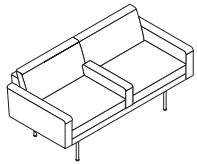

No Arm Caps

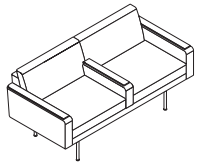

Arm Caps

MODEL NO.

ALLIANCE PROGRAM PRICE GRADES

			A	B	C	D	E	F	G	H	I
			J	K	L	M	N	O	P	Q	R
			K89L2CVABIUTB	No Arm Caps	\$ 4955	5210	5408	5607	5821	6076	6220
			6967	7348	8111	8595	8700	8795	8914	9026	9558
K89L2CVABIACWTB	Wood Arm Caps		5140	5395	5593	5792	6006	6261	6405	6682	6914
			7152	7533	8296	8780	8885	8980	9099	9211	9743
K89L2CVABIACPTB	Polyurethane Arm Caps		5368	5623	5821	6020	6234	6489	6633	6910	7142
			7380	7761	8524	9008	9113	9208	9327	9439	9971
K89L2CVABIACCTB	3D Laminate Arm Caps		6146	6401	6599	6798	7012	7267	7411	7688	7920
			8158	8539	9302	9786	9891	9986	10105	10217	10749
K89L2CVABIACSTB	Solid Surface Arm Caps		6452	6707	6905	7104	7318	7573	7717	7994	8226
			8464	8845	9608	10092	10197	10292	10411	10523	11055

DIMENSIONS

Width	62 $\frac{3}{8}$	Seat Height	18 $\frac{1}{2}$	Arm Height		Weight	140
Depth	29 $\frac{3}{4}$	Seat Depth	20 $\frac{1}{4}$	No Arm Cap	22 $\frac{3}{4}$	Cubic Ft.	38.00
Height	29 $\frac{3}{8}$	Seat Width	25 $\frac{1}{4}$	Arm Cap	22 $\frac{1}{4}$		
				Arm Width	3 $\frac{1}{2}$		

- Contrasting fabric option – specify X (i.e., K89L2CVABIUTBX); see page 776. For list pricing, use your electronic specification tool or contact customer service
- Weight Limit 253 lbs.
- Tight-back
- Clean out
- 2mm tubular metal legs
- Non-skid, adjustable glides
- Arm caps on applicable models

TO ORDER, SPECIFY:

- 1. Model Number
- 2. Inner Back Upholstery Grade
- 3. Inner Back Upholstery Number
- 4. Outer Back Upholstery Grade
- 5. Outer Back Upholstery Number
- 6. Seat Upholstery Grade
- 7. Seat Upholstery Number
- 8. Arm Upholstery Grade
- 9. Arm Upholstery Number
- 10. Front Panel/Accent Upholstery Grade
- 11. Front Panel/Accent Upholstery Number
- 12. Leg Metal Finish Designator
- 13. Arm Cap Finish or Color Designator (if applicable)
- 14. Moisture Barrier Optional for Seat, or Seat and Inside Back

- See page 775 for Whittaker Health options
- See pages 809-814 for COM fabric yardage

THREE SEAT INTERIOR ARM ON LEFT, CONVENIENCE ARM ON RIGHT LOUNGE

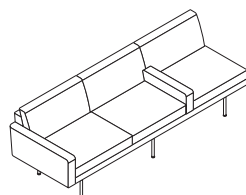

No Arm Caps

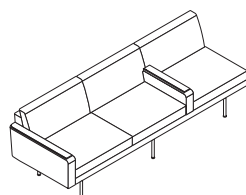

Arm Caps

MODEL NO.			ALLIANCE PROGRAM PRICE GRADES									
			A	B	C	D	E	F	G	H	I	
			J	K	L	M	N	O	P	Q	R	
K89L3CVARILUTB	No Arm Caps	\$	6158	6474	6719	6966	7232	7545	7724	8067	8352	
			8648	9120	10065	10664	10793	10911	11059	11197	11856	
K89L3CVARILACWTB	Wood Arm Caps		6237	6553	6798	7045	7311	7624	7803	8146	8431	
			8727	9199	10144	10743	10872	10990	11138	11276	11935	
K89L3CVARILACPTB	Polyurethane Arm Caps		6337	6653	6898	7145	7411	7724	7903	8246	8531	
			8827	9299	10244	10843	10972	11090	11238	11376	12035	
K89L3CVARILACTTB	3D Laminate Arm Caps		6968	7284	7529	7776	8042	8355	8534	8877	9162	
			9458	9930	10875	11474	11603	11721	11869	12007	12666	
K89L3CVARILACSTB	Solid Surface Arm Caps		7180	7496	7741	7988	8254	8567	8746	9089	9374	
			9670	10142	11087	11686	11815	11933	12081	12219	12878	

DIMENSIONS

Width	89½	Seat Height	18½	Arm Height		Weight	213
Depth	29¾	Seat Depth	20¾	No Arm Cap	22¾	Cubic Ft.	56.00
Height	29¾	Seat Width	25¾	Arm Cap	22¾		
				Arm Width	3½		

- Contrasting fabric option – specify X (i.e., K89L3CVARILUTBX); see page 776. For list pricing, use your electronic specification tool or contact customer service
- Weight Limit 253 lbs.
- Tight-back
- Clean out
- 2mm tubular metal legs
- Non-skid, adjustable glides
- Arm caps on applicable models

THREE SEAT INTERIOR ARM ON LEFT, CONVENIENCE ARMS ON BOTH SIDES LOUNGE

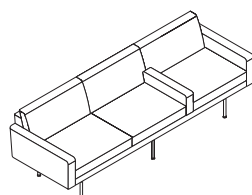

No Arm Caps

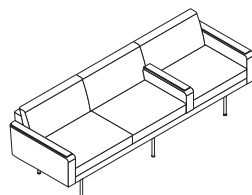

Arm Caps

MODEL NO.			ALLIANCE PROGRAM PRICE GRADES									
			A	B	C	D	E	F	G	H	I	
			J	K	L	M	N	O	P	Q	R	
K89L3CVABILUTB	No Arm Caps	\$	6543	6872	7126	7383	7659	7985	8171	8527	8824	
			9132	9622	10604	11227	11362	11484	11638	11781	12466	
K89L3CVABILACWTB	Wood Arm Caps		6577	6906	7160	7417	7693	8019	8205	8561	8858	
			9166	9656	10638	11261	11396	11518	11672	11815	12500	
K89L3CVABILACPTB	Polyurethane Arm Caps		6769	7098	7352	7609	7885	8211	8397	8753	9050	
			9358	9848	10830	11453	11588	11710	11864	12007	12692	
K89L3CVABILACTTB	3D Laminate Arm Caps		7729	8058	8312	8569	8845	9171	9357	9713	10010	
			10318	10808	11790	12413	12548	12670	12824	12967	13652	
K89L3CVABILACSTB	Solid Surface Arm Caps		8042	8371	8625	8882	9158	9484	9670	10026	10323	
			10631	11121	12103	12726	12861	12983	13137	13280	13965	

DIMENSIONS

Width	89½	Seat Height	18½	Arm Height		Weight	221
Depth	29¾	Seat Depth	20¾	No Arm Cap	22¾	Cubic Ft.	58.00
Height	29¾	Seat Width	25¾	Arm Cap	22¾		
				Arm Width	3½		

- Contrasting fabric option – specify X (i.e., K89L3CVABILUTBX); see page 776. For list pricing, use your electronic specification tool or contact customer service
- Weight Limit 253 lbs.
- Tight-back
- Clean out
- 2mm tubular metal legs
- Non-skid, adjustable glides
- Arm caps on applicable models

WHITTAKER HEALTH

TO ORDER, SPECIFY:

1. Model Number
2. Inner Back Upholstery Grade
3. Inner Back Upholstery Number
4. Outer Back Upholstery Grade
5. Outer Back Upholstery Number
6. Seat Upholstery Grade
7. Seat Upholstery Number
8. Arm Upholstery Grade
9. Arm Upholstery Number
10. Front Panel/Accent Upholstery Grade
11. Front Panel/Accent Upholstery Number
12. Leg Metal Finish Designator
13. Arm Cap Finish or Color Designator (if applicable)
14. Moisture Barrier Optional for Seat, or Seat and Inside Back

- See page 775 for Whittaker Health options
- See pages 809-814 for COM fabric yardage

THREE SEAT INTERIOR ARM ON RIGHT, CONVENIENCE ARM ON LEFT LOUNGE

MODEL NO.

ALLIANCE PROGRAM PRICE GRADES

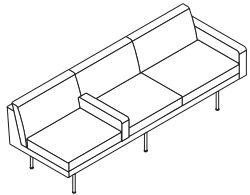

No Arm Caps

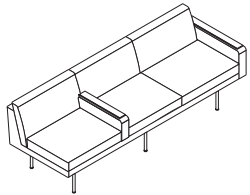

Arm Caps

			A	B	C	D	E	F	G	H	I
			J	K	L	M	N	O	P	Q	R
K89L3CVALIRUTB	No Arm Caps	\$	6158	6474	6719	6966	7232	7545	7724	8067	8352
			8648	9120	10065	10664	10793	10911	11059	11197	11856
K89L3CVALIRACWTB	Wood Arm Caps		6237	6553	6798	7045	7311	7624	7803	8146	8431
			8727	9199	10144	10743	10872	10990	11138	11276	11935
K89L3CVALIRACPTB	Polyurethane Arm Caps		6337	6653	6898	7145	7411	7724	7903	8246	8531
			8827	9299	10244	10843	10972	11090	11238	11376	12035
K89L3CVALIRACTTB	3D Laminate Arm Caps		6968	7284	7529	7776	8042	8355	8534	8877	9162
			9458	9930	10875	11474	11603	11721	11869	12007	12666
K89L3CVALIRACSTB	Solid Surface Arm Caps		7180	7496	7741	7988	8254	8567	8746	9089	9374
			9670	10142	11087	11686	11815	11933	12081	12219	12878

DIMENSIONS

Width	89 $\frac{1}{2}$	Seat Height	18 $\frac{1}{2}$	Arm Height		Weight	213
Depth	29 $\frac{3}{4}$	Seat Depth	20 $\frac{1}{4}$	No Arm Cap	22 $\frac{1}{4}$	Cubic Ft.	56.00
Height	29 $\frac{3}{8}$	Seat Width	25 $\frac{1}{4}$	Arm Cap	22 $\frac{1}{4}$		
				Arm Width	3 $\frac{1}{2}$		

- Contrasting fabric option – specify X (i.e., K89L3CVALIRUTBX); see page 776. For list pricing, use your electronic specification tool or contact customer service
- Weight Limit 253 lbs.
- Tight-back
- Clean out
- 2mm tubular metal legs
- Non-skid, adjustable glides
- Arm caps on applicable models

THREE SEAT INTERIOR ARM ON RIGHT, CONVENIENCE ARMS ON BOTH SIDES LOUNGE

			A	B	C	D	E	F	G	H	I
			J	K	L	M	N	O	P	Q	R
K89L3CVABIRUTB	No Arm Caps	\$	6543	6872	7126	7383	7659	7985	8171	8527	8824
			9132	9622	10604	11227	11362	11484	11638	11781	12466
K89L3CVABIRACWTB	Wood Arm Caps		6577	6906	7160	7417	7693	8019	8205	8561	8858
			9166	9656	10638	11261	11396	11518	11672	11815	12500
K89L3CVABIRACPTB	Polyurethane Arm Caps		6769	7098	7352	7609	7885	8211	8397	8753	9050
			9358	9848	10830	11453	11588	11710	11864	12007	12692
K89L3CVABIRACTTB	3D Laminate Arm Caps		7729	8058	8312	8569	8845	9171	9357	9713	10010
			10318	10808	11790	12413	12548	12670	12824	12967	13652
K89L3CVABIRACSTB	Solid Surface Arm Caps		8042	8371	8625	8882	9158	9484	9670	10026	10323
			10631	11121	12103	12726	12861	12983	13137	13280	13965

DIMENSIONS

Width	89 $\frac{1}{2}$	Seat Height	18 $\frac{1}{2}$	Arm Height		Weight	221
Depth	29 $\frac{3}{4}$	Seat Depth	20 $\frac{1}{4}$	No Arm Cap	22 $\frac{1}{4}$	Cubic Ft.	58.00
Height	29 $\frac{3}{8}$	Seat Width	25 $\frac{1}{4}$	Arm Cap	22 $\frac{1}{4}$		
				Arm Width	3 $\frac{1}{2}$		

- Contrasting fabric option – specify X (i.e., K89L3CVABIRUTBX); see page 776. For list pricing, use your electronic specification tool or contact customer service
- Weight Limit 253 lbs.
- Tight-back
- Clean out
- 2mm tubular metal legs
- Non-skid, adjustable glides
- Arm caps on applicable models

TO ORDER, SPECIFY:

- 1. Model Number
- 2. Inner Back Upholstery Grade
- 3. Inner Back Upholstery Number
- 4. Outer Back Upholstery Grade
- 5. Outer Back Upholstery Number
- 6. Seat Upholstery Grade
- 7. Seat Upholstery Number
- 8. Arm Upholstery Grade
- 9. Arm Upholstery Number
- 10. Front Panel/Accent Upholstery Grade
- 11. Front Panel/Accent Upholstery Number
- 12. Leg Metal Finish Designator
- 13. Arm Cap Finish or Color Designator (if applicable)
- 14. Moisture Barrier Optional for Seat, or Seat and Inside Back

- See page 775 for Whittaker Health options
- See pages 809-814 for COM fabric yardage

**THREE SEAT INTERIOR
ARMS ON LEFT AND RIGHT,
CONVENIENCE ARM ON
RIGHT LOUNGE**

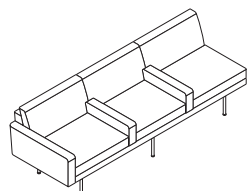

No Arm Caps

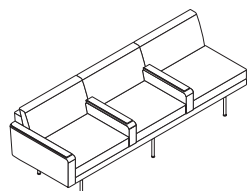

Arm Caps

MODEL NO.			ALLIANCE PROGRAM PRICE GRADES									
			A	B	C	D	E	F	G	H	I	
			J	K	L	M	N	O	P	Q	R	
K89L3CVARIBUTB	No Arm Caps	\$	6468	6805	7067	7330	7614	7948	8139	8504	8809	
			9125	9628	10636	11276	11414	11539	11697	11844	12547	
K89L3CVARIBACWTB	Wood Arm Caps		6564	6901	7163	7426	7710	8044	8235	8600	8905	
			9221	9724	10732	11372	11510	11635	11793	11940	12643	
K89L3CVARIBACPTB	Polyurethane Arm Caps		6699	7036	7298	7561	7845	8179	8370	8735	9040	
			9356	9859	10867	11507	11645	11770	11928	12075	12778	
K89L3CVARIBACTTB	3D Laminate Arm Caps		7628	7965	8227	8490	8774	9108	9299	9664	9969	
			10285	10788	11796	12436	12574	12699	12857	13004	13707	
K89L3CVARIBACSTB	Solid Surface Arm Caps		7952	8289	8551	8814	9098	9432	9623	9988	10293	
			10609	11112	12120	12760	12898	13023	13181	13328	14031	

DIMENSIONS

Width	89½	Seat Height	18½	Arm Height		Weight	221
Depth	29¾	Seat Depth	20¾	No Arm Cap	22¾	Cubic Ft.	58.00
Height	29¼	Seat Width	25¼	Arm Cap	22¼		
				Arm Width	3½		

- Contrasting fabric option – specify X (i.e., K89L3CVARIBUTBX); see page 776. For list pricing, use your electronic specification tool or contact customer service
- Weight Limit 253 lbs.
- Tight-back
- Clean out
- 2mm tubular metal legs
- Non-skid, adjustable glides
- Arm caps on applicable models

**THREE SEAT INTERIOR
ARMS ON LEFT AND RIGHT,
CONVENIENCE ARM ON
LEFT LOUNGE**

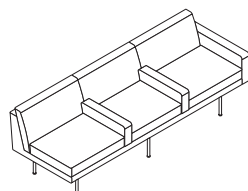

No Arm Caps

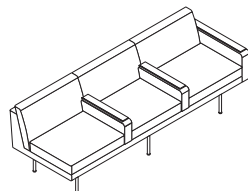

Arm Caps

MODEL NO.			ALLIANCE PROGRAM PRICE GRADES									
			A	B	C	D	E	F	G	H	I	
			J	K	L	M	N	O	P	Q	R	
K89L3CVALIBUTB	No Arm Caps	\$	6468	6805	7067	7330	7614	7948	8139	8504	8809	
			9125	9628	10636	11276	11414	11539	11697	11844	12547	
K89L3CVALIBACWTB	Wood Arm Caps		6564	6901	7163	7426	7710	8044	8235	8600	8905	
			9221	9724	10732	11372	11510	11635	11793	11940	12643	
K89L3CVALIBACPTB	Polyurethane Arm Caps		6699	7036	7298	7561	7845	8179	8370	8735	9040	
			9356	9859	10867	11507	11645	11770	11928	12075	12778	
K89L3CVALIBACTTB	3D Laminate Arm Caps		7628	7965	8227	8490	8774	9108	9299	9664	9969	
			10285	10788	11796	12436	12574	12699	12857	13004	13707	
K89L3CVALIBACSTB	Solid Surface Arm Caps		7952	8289	8551	8814	9098	9432	9623	9988	10293	
			10609	11112	12120	12760	12898	13023	13181	13328	14031	

DIMENSIONS

Width	89½	Seat Height	18½	Arm Height		Weight	220
Depth	29¾	Seat Depth	20¾	No Arm Cap	22¾	Cubic Ft.	56.00
Height	29¼	Seat Width	25¼	Arm Cap	22¼		
				Arm Width	3½		

- Contrasting fabric option – specify X (i.e., K89L3CVALIBUTBX); see page 776. For list pricing, use your electronic specification tool or contact customer service
- Weight Limit 253 lbs.
- Tight-back
- Clean out
- 2mm tubular metal legs
- Non-skid, adjustable glides
- Arm caps on applicable models

TO ORDER, SPECIFY:

1. Model Number
2. Inner Back Upholstery Grade
3. Inner Back Upholstery Number
4. Outer Back Upholstery Grade
5. Outer Back Upholstery Number
6. Seat Upholstery Grade
7. Seat Upholstery Number
8. Arm Upholstery Grade
9. Arm Upholstery Number
10. Front Panel/Accent Upholstery Grade
11. Front Panel/Accent Upholstery Number
12. Leg Metal Finish Designator
13. Arm Cap Finish or Color Designator (if applicable)
14. Moisture Barrier Optional for Seat, or Seat and Inside Back

- See page 775 for Whittaker Health options
- See pages 809-814 for COM fabric yardage

WHITTAKER HEALTH

**THREE SEAT INTERIOR
ARMS ON LEFT AND RIGHT,
CONVENIENCE ARMS ON
BOTH SIDES LOUNGE**

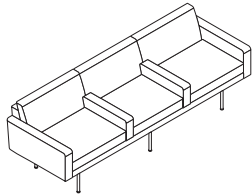

No Arm Caps

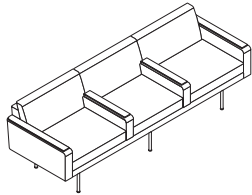

Arm Caps

**MODEL
NO.**

ALLIANCE PROGRAM PRICE GRADES

			A	B	C	D	E	F	G	H	I
			J	K	L	M	N	O	P	Q	R
			K89L3CVABIBUTB	No Arm Caps	\$ 6837	7174	7436	7699	7983	8317	8508
			9494	9997	11005	11645	11783	11908	12066	12213	12916
K89L3CVABIBACWTB	Wood Arm Caps	6847	7184	7446	7709	7993	8327	8518	8883	9188	
		9504	10007	11015	11655	11793	11918	12076	12223	12926	
K89L3CVABIBACPTB	Polyurethane Arm Caps	7131	7468	7730	7993	8277	8611	8802	9167	9472	
		9788	10291	11299	11939	12077	12202	12360	12507	13210	
K89L3CVABIBACTTB	3D Laminate Arm Caps	8388	8725	8987	9250	9534	9868	10059	10424	10729	
		11045	11548	12556	13196	13334	13459	13617	13764	14467	
K89L3CVABIBACSTB	Solid Surface Arm Caps	8786	9123	9385	9648	9932	10266	10457	10822	11127	
		11443	11946	12954	13594	13732	13857	14015	14162	14865	

DIMENSIONS

Width	89½	Seat Height	18½	Arm Height		Weight	228
Depth	29¾	Seat Depth	20¼	No Arm Cap	22¾	Cubic Ft.	58.00
Height	29¾	Seat Width	25¼	Arm Cap	22¼		
				Arm Width	3½		

- Contrasting fabric option – specify X (i.e., K89L3CVABIBUTBX); see page 776. For list pricing, use your electronic specification tool or contact customer service
- Weight Limit 253 lbs.
- Tight-back
- Clean out
- 2mm tubular metal legs
- Non-skid, adjustable glides
- Arm caps on applicable models

TO ORDER, SPECIFY:

1. Model Number
2. Inner Back Upholstery Grade
3. Inner Back Upholstery Number
4. Outer Back Upholstery Grade
5. Outer Back Upholstery Number
6. Seat Upholstery Grade
7. Seat Upholstery Number
8. Front Panel/Accent Upholstery Grade
9. Front Panel/Accent Upholstery Number
10. Leg Metal Finish Designator
11. Moisture Barrier Optional for Seat, or Seat and Inside Back

- See page 775 for Whittaker Health options
- See pages 809-814 for COM fabric yardage

ARMLESS LEFT CORNER LOUNGE

MODEL NO.

ALLIANCE PROGRAM PRICE GRADES

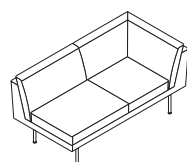

Two Seat

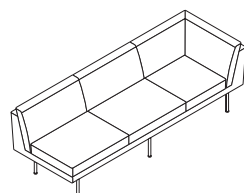

Three Seat

MODEL NO.	SEATING		A	B	C	D	E	F	G	H	I
			J	K	L	M	N	O	P	Q	R
K89C2LXATB	Two Seat	\$	4474	4708	4890	5071	5269	5501	5632	5887	6098
			6317	6666	7365	7809	7904	7991	8100	8202	8690
K89C3LXATB	Three Seat		5986	6292	6532	6771	7030	7335	7508	7843	8120
			8405	8865	9783	10365	10489	10604	10748	10881	11522

DIMENSIONS - TWO SEAT

Width	57 ¹ / ₆	Seat Height	18 ¹ / ₂	Weight	135
Depth	29 ³ / ₄	Seat Depth	20 ¹ / ₆	Cubic Ft.	37.00
Height	29 ¹ / ₆	Seat Width	47 ¹ / ₆		

DIMENSIONS - THREE SEAT

Width	84 ¹ / ₂	Seat Height	18 ¹ / ₂	Weight	182
Depth	29 ³ / ₄	Seat Depth	20 ¹ / ₆	Cubic Ft.	55.00
Height	29 ¹ / ₆	Seat Width	74 ³ / ₄		

- Contrasting fabric option – specify X (i.e., K89C2LXATBX); see page 776. For list pricing, use your electronic specification tool or contact customer service
- Weight Limit 253 lbs.
- Tight-back
- Clean out
- 2mm tubular metal legs
- Non-skid, adjustable glides

WHITTAKER HEALTH

WHITTAKER HEALTH

TO ORDER, SPECIFY:

1. Model Number
2. Inner Back Upholstery Grade
3. Inner Back Upholstery Number
4. Outer Back Upholstery Grade
5. Outer Back Upholstery Number
6. Seat Upholstery Grade
7. Seat Upholstery Number
8. Arm Upholstery Grade
9. Arm Upholstery Number
10. Front Panel/Accent Upholstery Grade
11. Front Panel/Accent Upholstery Number
12. Leg Metal Finish Designator
13. Arm Cap Finish or Color Designator (if applicable)
14. Moisture Barrier Optional for Seat, or Seat and Inside Back

- See page 775 for Whittaker Health options
- See pages 809-814 for COM fabric yardage

TWO SEAT LEFT CORNER CONVENIENCE ARM ON RIGHT LOUNGE

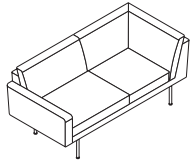

No Arm Cap

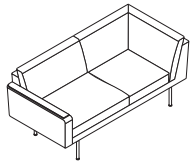

Arm Cap

MODEL NO.

ALLIANCE PROGRAM PRICE GRADES

			A	B	C	D	E	F	G	H	I
			J	K	L	M	N	O	P	Q	R
K89C2LCVAUTB	No Arm Cap	\$	4994	5269	5483	5696	5929	6202	6356	6656	6904
			7161	7572	8394	8916	9027	9130	9258	9378	9952
K89C2LCVAACWTB	Wood Arm Cap		5046	5321	5535	5748	5981	6254	6408	6708	6956
			7213	7624	8446	8968	9079	9182	9310	9430	10004
K89C2LCVAACPTB	Polyurethane Arm Cap		5075	5350	5564	5777	6010	6283	6437	6737	6985
			7242	7653	8475	8997	9108	9211	9339	9459	10033
K89C2LCVAACCTB	3D Laminate Arm Cap		5190	5465	5679	5892	6125	6398	6552	6852	7100
			7357	7768	8590	9112	9223	9326	9454	9574	10148
K89C2LCVAACSTB	Solid Surface Arm Cap		5396	5671	5885	6098	6331	6604	6758	7058	7306
			7563	7974	8796	9318	9429	9532	9660	9780	10354

DIMENSIONS

Width	62 $\frac{1}{2}$	Seat Height	18 $\frac{1}{2}$	Arm Height		Weight	142
Depth	29 $\frac{3}{4}$	Seat Depth	20 $\frac{1}{4}$	No Arm Cap	22 $\frac{1}{4}$	Cubic Ft.	40.00
Height	29 $\frac{3}{16}$	Seat Width	25 $\frac{1}{4}$	Arm Cap	22 $\frac{1}{4}$		
				Arm Width	3 $\frac{1}{2}$		

- Contrasting fabric option – specify X (i.e., K89C2LCVAUTBX); see page 776. For list pricing, use your electronic specification tool or contact customer service
- Weight Limit 253 lbs.
- Tight-back
- Clean out
- 2mm tubular metal legs
- Non-skid, adjustable glides
- Arm caps on applicable models

THREE SEAT LEFT CORNER CONVENIENCE ARM ON RIGHT LOUNGE

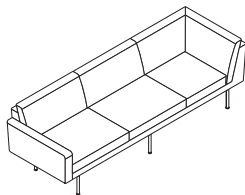

No Arm Cap

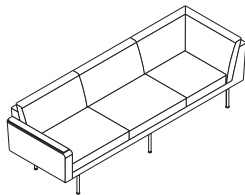

Arm Cap

			A	B	C	D	E	F	G	H	I
			J	K	L	M	N	O	P	Q	R
K89C3LCVAUTB	No Arm Cap	\$	6504	6851	7123	7394	7688	8034	8230	8610	8924
			9247	9769	10810	11470	11610	11741	11904	12055	12782
K89C3LCVAACWTB	Wood Arm Cap		6555	6902	7174	7445	7739	8085	8281	8661	8975
			9298	9820	10861	11521	11661	11792	11955	12106	12833
K89C3LCVAACPTB	Polyurethane Arm Cap		6585	6932	7204	7475	7769	8115	8311	8691	9005
			9328	9850	10891	11551	11691	11822	11985	12136	12863
K89C3LCVAACCTB	3D Laminate Arm Cap		6701	7048	7320	7591	7885	8231	8427	8807	9121
			9444	9966	11007	11667	11807	11938	12101	12252	12979
K89C3LCVAACSTB	Solid Surface Arm Cap		6906	7253	7525	7796	8090	8436	8632	9012	9326
			9649	10171	11212	11872	12012	12143	12306	12457	13184

DIMENSIONS

Width	88	Seat Height	18 $\frac{1}{2}$	Arm Height		Weight	190
Depth	29 $\frac{3}{4}$	Seat Depth	20 $\frac{1}{4}$	No Arm Cap	22 $\frac{1}{4}$	Cubic Ft.	57.00
Height	29 $\frac{3}{16}$	Seat Width	74 $\frac{1}{4}$	Arm Cap	22 $\frac{1}{4}$		
				Arm Width	3 $\frac{1}{2}$		

- Contrasting fabric option – specify X (i.e., K89C3LCVAUTBX); see page 776. For list pricing, use your electronic specification tool or contact customer service
- Weight Limit 253 lbs.
- Tight-back
- Clean out
- 2mm tubular metal legs
- Non-skid, adjustable glides
- Arm caps on applicable models

TO ORDER, SPECIFY:

1. Model Number
2. Inner Back Upholstery Grade
3. Inner Back Upholstery Number
4. Outer Back Upholstery Grade
5. Outer Back Upholstery Number
6. Seat Upholstery Grade
7. Seat Upholstery Number
8. Arm Upholstery Grade
9. Arm Upholstery Number
10. Front Panel/Accent Upholstery Grade
11. Front Panel/Accent Upholstery Number
12. Leg Metal Finish Designator
13. Moisture Barrier Optional for Seat, or Seat and Inside Back

- See page 775 for Whittaker Health options
- See pages 809-814 for COM fabric yardage

**FULL ARM ON RIGHT
LEFT CORNER LOUNGE**

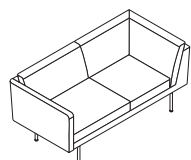

Two Seat

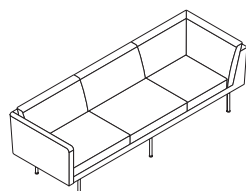

Three Seat

**MODEL
NO.**

ALLIANCE PROGRAM PRICE GRADES

		A	B	C	D	E	F	G	H	I
		J	K	L	M	N	O	P	Q	R
K89C2LFATB	Two Seat	\$ 4999	5278	5496	5712	5949	6226	6383	6687	6939
		7201	7618	8453	8984	9098	9202	9332	9454	10037
K89C3LFATB	Three Seat	6510	6861	7137	7411	7709	8059	8258	8642	8960
		9288	9816	10870	11539	11682	11814	11979	12132	12868

DIMENSIONS - TWO SEAT

Width	59½	Seat Height	18½	Arm Height	26½	Weight	142
Depth	29¾	Seat Depth	20½	Arm Width	2	Cubic Ft.	39.00
Height	29⅜	Seat Width	47½				

DIMENSIONS - THREE SEAT

Width	86½	Seat Height	18½	Arm Height	26½	Weight	190
Depth	29¾	Seat Depth	20½	Arm Width	2	Cubic Ft.	56.00
Height	29⅜	Seat Width	74¾				

- Contrasting fabric option – specify X (i.e., K89C2LFATBX); see page 776. For list pricing, use your electronic specification tool or contact customer service
- Weight Limit 253 lbs.
- Tight-back
- Clean out
- 2mm tubular metal legs
- Non-skid, adjustable glides

**THREE SEAT LEFT CORNER,
INTERIOR ARM ON RIGHT
LOUNGE**

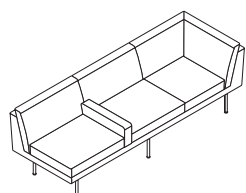

		A	B	C	D	E	F	G	H	I
		J	K	L	M	N	O	P	Q	R
K89C3LXAIRTB	Three Seat	\$ 5861	6206	6476	6746	7038	7382	7577	7954	8267
		8588	9107	10142	10798	10938	11068	11230	11380	12103

DIMENSIONS

Width	84½	Seat Height	18½	Arm Height	22½	Weight	189
Depth	29¾	Seat Depth	20½	Arm Width	3½	Cubic Ft.	55.00
Height	29⅜	Seat Width	25⅜				

- Contrasting fabric option – specify X (i.e., K89C3LXAIRTBX); see page 776. For list pricing, use your electronic specification tool or contact customer service
- Weight Limit 253 lbs.
- Tight-back
- Clean out
- 2mm tubular metal legs
- Non-skid, adjustable glides

TO ORDER, SPECIFY:

1. Model Number
2. Inner Back Upholstery Grade
3. Inner Back Upholstery Number
4. Outer Back Upholstery Grade
5. Outer Back Upholstery Number
6. Seat Upholstery Grade
7. Seat Upholstery Number
8. Arm Upholstery Grade
9. Arm Upholstery Number
10. Front Panel/Accent Upholstery Grade
11. Front Panel/Accent Upholstery Number
12. Leg Metal Finish Designator
13. Arm Cap Finish or Color Designator (if applicable)
14. Moisture Barrier Optional for Seat, or Seat and Inside Back

- See page 775 for Whittaker Health options
- See pages 809-814 for COM fabric yardage

WHITTAKER HEALTH

THREE SEAT LEFT CORNER, INTERIOR ARM ON RIGHT, CONVENIENCE ARM ON RIGHT LOUNGE

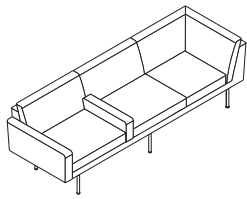

No Arm Caps

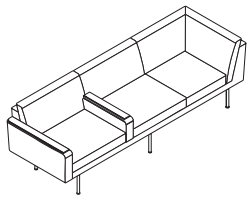

Arm Caps

MODEL NO.

ALLIANCE PROGRAM PRICE GRADES

			A	B	C	D	E	F	G	H	I
			J	K	L	M	N	O	P	Q	R
			K89C3LCVAUIRTB	No Arm Caps	\$ 6486	6833	7105	7376	7670	8016	8212
			9229	9751	10792	11452	11592	11723	11886	12037	12764
K89C3LCVAACWIRTB	Wood Arm Caps	6554	6901	7173	7444	7738	8084	8280	8660	8974	
			9297	9819	10860	11520	11660	11791	11954	12105	12832
K89C3LCVAACPIRTB	Polyurethane Arm Caps	6649	6996	7268	7539	7833	8179	8375	8755	9069	
			9392	9914	10955	11615	11755	11886	12049	12200	12927
K89C3LCVAACTIRTB	3D Laminate Arm Caps	6839	7186	7458	7729	8023	8369	8565	8945	9259	
			9582	10104	11145	11805	11945	12076	12239	12390	13117
K89C3LCVAACSIRTB	Solid Surface Arm Caps	7287	7634	7906	8177	8471	8817	9013	9393	9707	
			10030	10552	11593	12253	12393	12524	12687	12838	13565

DIMENSIONS

Width	88	Seat Height	18 $\frac{1}{2}$	Arm Height		Weight	197
Depth	29 $\frac{3}{4}$	Seat Depth	20 $\frac{1}{4}$	No Arm Cap	22 $\frac{3}{4}$	Cubic Ft.	57.00
Height	29 $\frac{3}{16}$	Seat Width	25 $\frac{1}{16}$	Arm Cap	22 $\frac{1}{16}$		
				Arm Width	3 $\frac{1}{2}$		

- Contrasting fabric option – specify X (i.e., K89C3LCVAUIRTBX); see page 776. For list pricing, use your electronic specification tool or contact customer service
- Weight Limit 253 lbs.
- Tight-back
- Clean out
- 2mm tubular metal legs
- Non-skid, adjustable glides
- Arm caps on applicable models

TO ORDER, SPECIFY:

1. Model Number
2. Inner Back Upholstery Grade
3. Inner Back Upholstery Number
4. Outer Back Upholstery Grade
5. Outer Back Upholstery Number
6. Seat Upholstery Grade
7. Seat Upholstery Number
8. Front Panel/Accent Upholstery Grade
9. Front Panel/Accent Upholstery Number
10. Leg Metal Finish Designator
11. Moisture Barrier Optional for Seat, or Seat and Inside Back

- See page 775 for Whittaker Health options
- See pages 809-814 for COM fabric yardage

ARMLESS RIGHT CORNER LOUNGE

MODEL NO.

ALLIANCE PROGRAM PRICE GRADES

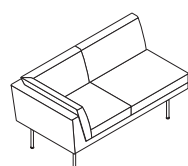

Two Seat

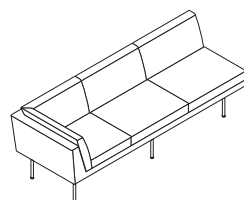

Three Seat

			A	B	C	D	E	F	G	H	I
			J	K	L	M	N	O	P	Q	R
K89C2RXATB	Two Seat	\$	4474	4708	4890	5071	5269	5501	5632	5887	6098
			6317	6666	7365	7809	7904	7991	8100	8202	8690
K89C3RXATB	Three Seat		5986	6292	6532	6771	7030	7335	7508	7843	8120
			8405	8865	9783	10365	10489	10604	10748	10881	11522

DIMENSIONS - TWO SEAT

Width	57 ¹ / ₆	Seat Height	18 ¹ / ₂	Weight	135
Depth	29 ³ / ₄	Seat Depth	20 ¹ / ₆	Cubic Ft.	37.00
Height	29 ¹ / ₆	Seat Width	47 ¹ / ₆		

DIMENSIONS - THREE SEAT

Width	84 ¹ / ₂	Seat Height	18 ¹ / ₂	Weight	182
Depth	29 ³ / ₄	Seat Depth	20 ¹ / ₆	Cubic Ft.	55.00
Height	29 ¹ / ₆	Seat Width	74 ³ / ₄		

- Contrasting fabric option – specify X (i.e., K89C2RXATBX); see page 776. For list pricing, use your electronic specification tool or contact customer service
- Weight Limit 253 lbs.
- Tight-back
- Clean out
- 2mm tubular metal legs
- Non-skid, adjustable glides

WHITTAKER HEALTH

TO ORDER, SPECIFY:

1. Model Number
2. Inner Back Upholstery Grade
3. Inner Back Upholstery Number
4. Outer Back Upholstery Grade
5. Outer Back Upholstery Number
6. Seat Upholstery Grade
7. Seat Upholstery Number
8. Arm Upholstery Grade
9. Arm Upholstery Number
10. Front Panel/Accent Upholstery Grade
11. Front Panel/Accent Upholstery Number
12. Leg Metal Finish Designator
13. Arm Cap Finish or Color Designator (if applicable)
14. Moisture Barrier Optional for Seat, or Seat and Inside Back

- See page 775 for Whittaker Health options
- See pages 809-814 for COM fabric yardage

TWO SEAT RIGHT CORNER CONVENIENCE ARM ON LEFT LOUNGE

MODEL NO.

ALLIANCE PROGRAM PRICE GRADES

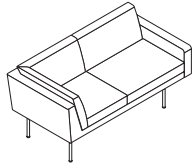

No Arm Cap

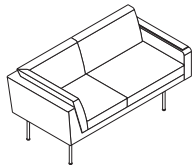

Arm Cap

			A	B	C	D	E	F	G	H	I
			J	K	L	M	N	O	P	Q	R
K89C2RCVAUTB	No Arm Cap	\$	4994	5269	5483	5696	5929	6202	6356	6656	6904
			7161	7572	8394	8916	9027	9130	9258	9378	9952
K89C2RCVAACWTB	Wood Arm Cap		5046	5321	5535	5748	5981	6254	6408	6708	6956
			7213	7624	8446	8968	9079	9182	9310	9430	10004
K89C2RCVAACPTB	Polyurethane Arm Cap		5075	5350	5564	5777	6010	6283	6437	6737	6985
			7242	7653	8475	8997	9108	9211	9339	9459	10033
K89C2RCVAACCTB	3D Laminate Arm Cap		5190	5465	5679	5892	6125	6398	6552	6852	7100
			7357	7768	8590	9112	9223	9326	9454	9574	10148
K89C2RCVAACSTB	Solid Surface Arm Cap		5396	5671	5885	6098	6331	6604	6758	7058	7306
			7563	7974	8796	9318	9429	9532	9660	9780	10354

DIMENSIONS

Width	62 $\frac{1}{2}$	Seat Height	18 $\frac{1}{2}$	Arm Height		Weight	142
Depth	29 $\frac{3}{4}$	Seat Depth	20 $\frac{1}{4}$	No Arm Cap	22 $\frac{1}{4}$	Cubic Ft.	40.00
Height	29 $\frac{3}{8}$	Seat Width	47 $\frac{1}{4}$	Arm Cap	22 $\frac{1}{8}$		
				Arm Width	3 $\frac{1}{2}$		

- Contrasting fabric option – specify X (i.e., K89C2RCVAUTBX); see page 776. For list pricing, use your electronic specification tool or contact customer service
- Weight Limit 253 lbs.
- Tight-back
- Clean out
- 2mm tubular metal legs
- Non-skid, adjustable glides
- Arm caps on applicable models

THREE SEAT RIGHT CORNER CONVENIENCE ARM ON LEFT LOUNGE

			A	B	C	D	E	F	G	H	I
			J	K	L	M	N	O	P	Q	R
K89C3RCVAUTB	No Arm Cap	\$	6504	6851	7123	7394	7688	8034	8230	8610	8924
			9247	9769	10810	11470	11610	11741	11904	12055	12782
K89C3RCVAACWTB	Wood Arm Cap		6555	6902	7174	7445	7739	8085	8281	8661	8975
			9298	9820	10861	11521	11661	11792	11955	12106	12833
K89C3RCVAACPTB	Polyurethane Arm Cap		6585	6932	7204	7475	7769	8115	8311	8691	9005
			9328	9850	10891	11551	11691	11822	11985	12136	12863
K89C3RCVAACCTB	3D Laminate Arm Cap		6701	7048	7320	7591	7885	8231	8427	8807	9121
			9444	9966	11007	11667	11807	11938	12101	12252	12979
K89C3RCVAACSTB	Solid Surface Arm Cap		6906	7253	7525	7796	8090	8436	8632	9012	9326
			9649	10171	11212	11872	12012	12143	12306	12457	13184

DIMENSIONS

Width	88	Seat Height	18 $\frac{1}{2}$	Arm Height		Weight	190
Depth	29 $\frac{3}{4}$	Seat Depth	20 $\frac{1}{4}$	No Arm Cap	22 $\frac{1}{4}$	Cubic Ft.	57.00
Height	29 $\frac{3}{8}$	Seat Width	74 $\frac{1}{4}$	Arm Cap	22 $\frac{1}{8}$		
				Arm Width	3 $\frac{1}{2}$		

- Contrasting fabric option – specify X (i.e., K89C3RCVAUTBX); see page 776. For list pricing, use your electronic specification tool or contact customer service
- Weight Limit 253 lbs.
- Tight-back
- Clean out
- 2mm tubular metal legs
- Non-skid, adjustable glides
- Arm caps on applicable models

TO ORDER, SPECIFY:

1. Model Number
2. Inner Back Upholstery Grade
3. Inner Back Upholstery Number
4. Outer Back Upholstery Grade
5. Outer Back Upholstery Number
6. Seat Upholstery Grade
7. Seat Upholstery Number
8. Arm Upholstery Grade
9. Arm Upholstery Number
10. Front Panel/Accent Upholstery Grade
11. Front Panel/Accent Upholstery Number
12. Leg Metal Finish Designator
13. Moisture Barrier Optional for Seat, or Seat and Inside Back

- See page 775 for Whittaker Health options
- See pages 809-814 for COM fabric yardage

**FULL ARM ON LEFT RIGHT
CORNER LOUNGE**

**MODEL
NO.**

ALLIANCE PROGRAM PRICE GRADES

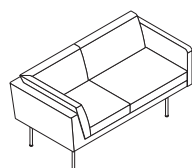

Two Seat

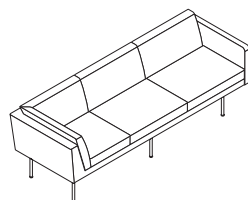

Three Seat

			A	B	C	D	E	F	G	H	I
			J	K	L	M	N	O	P	Q	R
K89C2RFATB	Two Seat	\$	4999	5278	5496	5712	5949	6226	6383	6687	6939
			7201	7618	8453	8984	9098	9202	9332	9454	10037
K89C3RFATB	Three Seat		6510	6861	7137	7411	7709	8059	8258	8642	8960
			9288	9816	10870	11539	11682	11814	11979	12132	12868

DIMENSIONS - TWO SEAT

Width	59½	Seat Height	18½	Arm Height	26½	Weight	142
Depth	29¾	Seat Depth	20⅞	Arm Width	2	Cubic Ft.	39.00
Height	29⅞	Seat Width	47⅞				

DIMENSIONS - THREE SEAT

Width	86½	Seat Height	18½	Arm Height	26½	Weight	190
Depth	29¾	Seat Depth	20⅞	Arm Width	2	Cubic Ft.	56.00
Height	29⅞	Seat Width	74¾				

- Contrasting fabric option – specify X (i.e., K89C2RFATBX); see page 776. For list pricing, use your electronic specification tool or contact customer service
- Weight Limit 253 lbs.
- Tight-back
- Clean out
- 2mm tubular metal legs
- Non-skid, adjustable glides

WHITTAKER HEALTH

TO ORDER, SPECIFY:

1. Model Number
2. Inner Back Upholstery Grade
3. Inner Back Upholstery Number
4. Outer Back Upholstery Grade
5. Outer Back Upholstery Number
6. Seat Upholstery Grade
7. Seat Upholstery Number
8. Arm Upholstery Grade
9. Arm Upholstery Number
10. Front Panel/Accent Upholstery Grade
11. Front Panel/Accent Upholstery Number
12. Leg Metal Finish Designator
13. Moisture Barrier Optional for Seat, or Seat and Inside Back

- See page 775 for Whittaker Health options
- See pages 809-814 for COM fabric yardage

THREE SEAT RIGHT CORNER, INTERIOR ARM ON LEFT LOUNGE

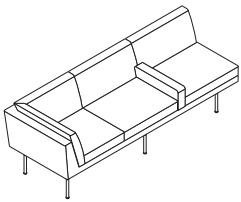

MODEL NO.

ALLIANCE PROGRAM PRICE GRADES

		A	B	C	D	E	F	G	H	I
		J	K	L	M	N	O	P	Q	R
K89C3RXAILTB	Three Seat	\$ 5861	6206	6476	6746	7038	7382	7577	7954	8267
		8588	9107	10142	10798	10938	11068	11230	11380	12103

DIMENSIONS

Width	84½	Seat Height	18¾	Arm Height	22¾	Weight	189
Depth	29¾	Seat Depth	20¾	Arm Width	3½	Cubic Ft.	55.00
Height	29¾	Seat Width	25¾				

- Contrasting fabric option – specify X (i.e., K89C3RXAILTBX); see page 776. For list pricing, use your electronic specification tool or contact customer service
- Weight Limit 253 lbs.
- Tight-back
- Clean out
- 2mm tubular metal legs
- Non-skid, adjustable glides

TO ORDER, SPECIFY:

1. Model Number
2. Inner Back Upholstery Grade
3. Inner Back Upholstery Number
4. Outer Back Upholstery Grade
5. Outer Back Upholstery Number
6. Seat Upholstery Grade
7. Seat Upholstery Number
8. Arm Upholstery Grade
9. Arm Upholstery Number
10. Front Panel/Accent Upholstery Grade
11. Front Panel/Accent Upholstery Number
12. Leg Metal Finish Designator
13. Arm Cap Finish or Color Designator (if applicable)
14. Moisture Barrier Optional for Seat, or Seat and Inside Back

- See page 775 for Whittaker Health options
- See pages 809-814 for COM fabric yardage

THREE SEAT RIGHT CORNER, INTERIOR ARM ON LEFT, CONVENIENCE ARM ON LEFT LOUNGE

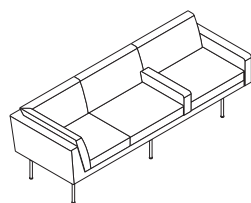

No Arm Caps

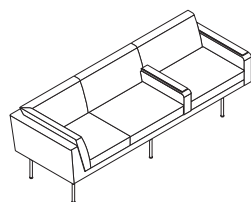

Arm Caps

MODEL NO.

ALLIANCE PROGRAM PRICE GRADES

			A	B	C	D	E	F	G	H	I
			J	K	L	M	N	O	P	Q	R
K89C3RCVAUILTB	No Arm Caps	\$	6486	6833	7105	7376	7670	8016	8212	8592	8906
			9229	9751	10792	11452	11592	11723	11886	12037	12764
K89C3RCVAACWILTB	Wood Arm Caps		6554	6901	7173	7444	7738	8084	8280	8660	8974
			9297	9819	10860	11520	11660	11791	11954	12105	12832
K89C3RCVAACPILTB	Polyurethane Arm Caps		6649	6996	7268	7539	7833	8179	8375	8755	9069
			9392	9914	10955	11615	11755	11886	12049	12200	12927
K89C3RCVAACILTB	3D Laminate Arm Caps		6839	7186	7458	7729	8023	8369	8565	8945	9259
			9582	10104	11145	11805	11945	12076	12239	12390	13117
K89C3RCVAACSILTB	Solid Surface Arm Caps		7287	7634	7906	8177	8471	8817	9013	9393	9707
			10030	10552	11593	12253	12393	12524	12687	12838	13565

DIMENSIONS

Width	88	Seat Height	18 $\frac{1}{8}$	Arm Height		Weight	197
Depth	29 $\frac{3}{4}$	Seat Depth	20 $\frac{1}{4}$	No Arm Cap	22 $\frac{3}{4}$	Cubic Ft.	57.00
Height	29 $\frac{3}{16}$	Seat Width	25 $\frac{1}{16}$	Arm Cap	22 $\frac{1}{4}$		
				Arm Width	3 $\frac{1}{2}$		

- Contrasting fabric option – specify X (i.e., K89C3RCVAUILTBX); see page 776. For list pricing, use your electronic specification tool or contact customer service
- Weight Limit 253 lbs.
- Tight-back
- Clean out
- 2mm tubular metal legs
- Non-skid, adjustable glides
- Arm caps on applicable models

WHITTAKER HEALTH

TO ORDER, SPECIFY:

1. Model Number
2. Inner Back Upholstery Grade
3. Inner Back Upholstery Number
4. Outer Back Upholstery Grade
5. Outer Back Upholstery Number
6. Seat Upholstery Grade
7. Seat Upholstery Number
8. Front Panel/Accent Upholstery Grade
9. Front Panel/Accent Upholstery Number
10. Leg Metal Finish Designator
11. Moisture Barrier Optional for Seat, or Seat and Inside Back

- See page 775 for Whittaker Health options
- See pages 809-814 for COM fabric yardage

TWO SEAT ARMLESS, PENINSULA LOUNGE

MODEL NO.

ALLIANCE PROGRAM PRICE GRADES

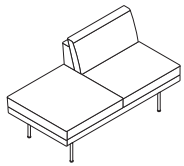

Back on Left Side

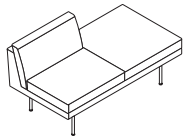

Back on Right Side

			A	B	C	D	E	F	G	H	I
			J	K	L	M	N	O	P	Q	R
K89PE2LTB	Back on Left Side	\$	3900	4077	4215	4353	4503	4680	4779	4971	5132
			5297	5562	6092	6429	6500	6567	6649	6726	7097
K89PE2RTB	Back on Right Side		3900	4077	4215	4353	4503	4680	4779	4971	5132
			5297	5562	6092	6429	6500	6567	6649	6726	7097

DIMENSIONS

Width	55½	Seat Height	18½	Weight	107
Depth	29¾	Seat Depth	20½	Cubic Ft.	36.00
Height	29¾	Seat Width	55½		

- Contrasting fabric option – specify X (i.e., K89PE2LTBX); see page 776. For list pricing, use your electronic specification tool or contact customer service
- Weight Limit 253 lbs.
- Tight-back
- Clean out
- 2mm tubular metal legs
- Non-skid, adjustable glides

THREE SEAT ARMLESS, PENINSULA LOUNGE

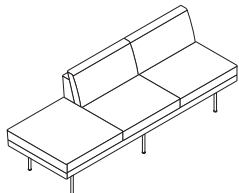

Back on Left Side

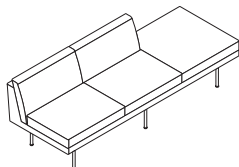

Back on Right Side

			A	B	C	D	E	F	G	H	I
			J	K	L	M	N	O	P	Q	R
K89PE3LTB	Back on Left Side	\$	5333	5588	5788	5987	6202	6457	6601	6879	7111
			7350	7732	8498	8983	9087	9183	9302	9414	9948
K89PE3RTB	Back on Right Side		5333	5588	5788	5987	6202	6457	6601	6879	7111
			7350	7732	8498	8983	9087	9183	9302	9414	9948

DIMENSIONS

Width	82½	Seat Height	18½	Weight	181
Depth	29¾	Seat Depth	20½	Cubic Ft.	53.00
Height	29¾	Seat Width	82½		

- Contrasting fabric option – specify X (i.e., K89PE3LTBX); see page 776. For list pricing, use your electronic specification tool or contact customer service
- Weight Limit 253 lbs.
- Tight-back
- Clean out
- 2mm tubular metal legs
- Non-skid, adjustable glides

TO ORDER, SPECIFY:

- 1. Model Number
- 2. Inner Back Upholstery Grade
- 3. Inner Back Upholstery Number
- 4. Outer Back Upholstery Grade
- 5. Outer Back Upholstery Number
- 6. Seat Upholstery Grade
- 7. Seat Upholstery Number
- 8. Arm Upholstery Grade
- 9. Arm Upholstery Number
- 10. Front Panel/Accent Upholstery Grade
- 11. Front Panel/Accent Upholstery Number
- 12. Leg Metal Finish Designator
- 13. Arm Cap Finish or Color Designator (if applicable)
- 14. Moisture Barrier Optional for Seat, or Seat and Inside Back

- See page 775 for Whittaker Health options
- See pages 809-814 for COM fabric yardage

TWO SEAT BACK AND CONVENIENCE ARM ON LEFT, PENINSULA LOUNGE

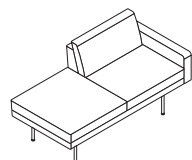

No Arm Cap

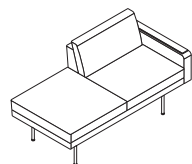

Arm Cap

MODEL NO.

ALLIANCE PROGRAM PRICE GRADES

		A	B	C	D	E	F	G	H	I
		J	K	L	M	N	O	P	Q	R
K89PE2RCVARUTB	No Arm Cap	\$ 4528	4746	4916	5086	5271	5489	5611	5848	6046
		6249	6576	7229	7644	7731	7814	7915	8010	8467
K89PE2RCVARACWTB	Wood Arm Cap	4579	4797	4967	5137	5322	5540	5662	5899	6097
		6300	6627	7280	7695	7782	7865	7966	8061	8518
K89PE2RCVARACPTB	Polyurethane Arm Cap	4609	4827	4997	5167	5352	5570	5692	5929	6127
		6330	6657	7310	7725	7812	7895	7996	8091	8548
K89PE2RCVARACTTB	3D Laminate Arm Cap	4724	4942	5112	5282	5467	5685	5807	6044	6242
		6445	6772	7425	7840	7927	8010	8111	8206	8663
K89PE2RCVARACSTB	Solid Surface Arm Cap	4931	5149	5319	5489	5674	5892	6014	6251	6449
		6652	6979	7632	8047	8134	8217	8318	8413	8870

DIMENSIONS

Width	58%	Seat Height	18%	Arm Height		Weight	115
Depth	29%	Seat Depth	20%	No Arm Cap	22 ³ / ₁₆	Cubic Ft.	38.00
Height	29 ¹³ / ₁₆	Seat Width	55%	Arm Cap	22 ¹ / ₁₆		
				Arm Width	3 ¹ / ₂		

- Contrasting fabric option – specify X (i.e., K89PE2RCVARUTBX); see page 776. For list pricing, use your electronic specification tool or contact customer service
- Weight Limit 253 lbs.
- Tight-back
- Clean out
- 2mm tubular metal legs
- Non-skid, adjustable glides
- Arm cap on applicable models

THREE SEAT BACK AND CONVENIENCE ARM ON LEFT, PENINSULA LOUNGE

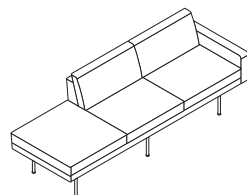

No Arm Cap

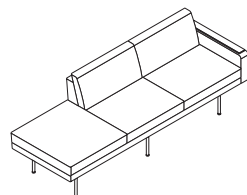

Arm Cap

		A	B	C	D	E	F	G	H	I
		J	K	L	M	N	O	P	Q	R
K89PE3RCVARUTB	No Arm Cap	\$ 5770	6066	6298	6529	6779	7075	7242	7565	7834
		8111	8555	9444	10007	10127	10239	10377	10507	11127
K89PE3RCVARACWTB	Wood Arm Cap	5967	6263	6495	6726	6976	7272	7439	7762	8031
		8308	8752	9641	10204	10324	10436	10574	10704	11324
K89PE3RCVARACPTB	Polyurethane Arm Cap	6108	6404	6636	6867	7117	7413	7580	7903	8172
		8449	8893	9782	10345	10465	10577	10715	10845	11465
K89PE3RCVARACTTB	3D Laminate Arm Cap	6225	6521	6753	6984	7234	7530	7697	8020	8289
		8566	9010	9899	10462	10582	10694	10832	10962	11582
K89PE3RCVARACSTB	Solid Surface Arm Cap	6429	6725	6957	7188	7438	7734	7901	8224	8493
		8770	9214	10103	10666	10786	10898	11036	11166	11786

DIMENSIONS

Width	88	Seat Height	18%	Arm Height		Weight	188
Depth	29%	Seat Depth	20%	No Arm Cap	22 ³ / ₁₆	Cubic Ft.	56.00
Height	29 ¹³ / ₁₆	Seat Width	25%	Arm Cap	22 ¹ / ₁₆		
				Arm Width	3 ¹ / ₂		

- Contrasting fabric option – specify X (i.e., K89PE3RCVARUTBX); see page 776. For list pricing, use your electronic specification tool or contact customer service
- Weight Limit 253 lbs.
- Tight-back
- Clean out
- 2mm tubular metal legs
- Non-skid, adjustable glides
- Arm cap on applicable models

WHITTAKER HEALTH

TO ORDER, SPECIFY:

1. Model Number
2. Inner Back Upholstery Grade
3. Inner Back Upholstery Number
4. Outer Back Upholstery Grade
5. Outer Back Upholstery Number
6. Seat Upholstery Grade
7. Seat Upholstery Number
8. Arm Upholstery Grade
9. Arm Upholstery Number
10. Front Panel/Accent Upholstery Grade
11. Front Panel/Accent Upholstery Number
12. Leg Metal Finish Designator
13. Arm Cap Finish or Color Designator (if applicable)
14. Moisture Barrier Optional for Seat, or Seat and Inside Back

- See page 775 for Whittaker Health options
- See pages 809-814 for COM fabric yardage

TWO SEAT BACK AND CONVENIENCE ARM ON RIGHT, PENINSULA LOUNGE

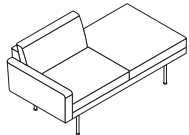

No Arm Cap

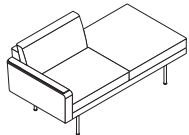

Arm Cap

MODEL NO.

ALLIANCE PROGRAM PRICE GRADES

			A	B	C	D	E	F	G	H	I
			J	K	L	M	N	O	P	Q	R
K89PE2LCVALUTB	No Arm Cap	\$	4528	4746	4916	5086	5271	5489	5611	5848	6046
			6249	6576	7229	7644	7731	7814	7915	8010	8467
K89PE2LCVALACWTB	Wood Arm Cap		4579	4797	4967	5137	5322	5540	5662	5899	6097
			6300	6627	7280	7695	7782	7865	7966	8061	8518
K89PE2LCVALACPTB	Polyurethane Arm Cap		4609	4827	4997	5167	5352	5570	5692	5929	6127
			6330	6657	7310	7725	7812	7895	7996	8091	8548
K89PE2LCVALACTTB	3D Laminate Arm Cap		4724	4942	5112	5282	5467	5685	5807	6044	6242
			6445	6772	7425	7840	7927	8010	8111	8206	8663
K89PE2LCVALACSTB	Solid Surface Arm Cap		4931	5149	5319	5489	5674	5892	6014	6251	6449
			6652	6979	7632	8047	8134	8217	8318	8413	8870

DIMENSIONS

Width	58%	Seat Height	18%	Arm Height		Weight	115
Depth	29%	Seat Depth	20%	No Arm Cap	22 ³ / ₁₆	Cubic Ft.	38.00
Height	29 ³ / ₁₆	Seat Width	55%	Arm Cap	22 ¹ / ₁₆		
				Arm Width	3 ¹ / ₂		

- Contrasting fabric option – specify X (i.e., K89PE2LCVALUTBX); see page 776. For list pricing, use your electronic specification tool or contact customer service
- Weight Limit 253 lbs.
- Tight-back
- Clean out
- 2mm tubular metal legs
- Non-skid, adjustable glides
- Arm cap on applicable models

THREE SEAT BACK AND CONVENIENCE ARM ON RIGHT, PENINSULA LOUNGE

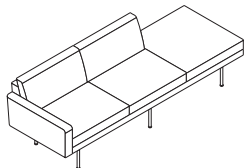

No Arm Cap

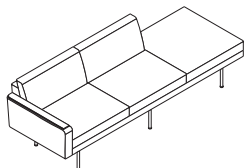

Arm Cap

			A	B	C	D	E	F	G	H	I
			J	K	L	M	N	O	P	Q	R
K89PE3LCVALUTB	No Arm Cap	\$	5770	6066	6298	6529	6779	7075	7242	7565	7834
			8111	8555	9444	10007	10127	10239	10377	10507	11127
K89PE3LCVALACWTB	Wood Arm Cap		5967	6263	6495	6726	6976	7272	7439	7762	8031
			8308	8752	9641	10204	10324	10436	10574	10704	11324
K89PE3LCVALACPTB	Polyurethane Arm Cap		6108	6404	6636	6867	7117	7413	7580	7903	8172
			8449	8893	9782	10345	10465	10577	10715	10845	11465
K89PE3LCVALACTTB	3D Laminate Arm Cap		6225	6521	6753	6984	7234	7530	7697	8020	8289
			8566	9010	9899	10462	10582	10694	10832	10962	11582
K89PE3LCVALACSTB	Solid Surface Arm Cap		6429	6725	6957	7188	7438	7734	7901	8224	8493
			8770	9214	10103	10666	10786	10898	11036	11166	11786

DIMENSIONS

Width	88	Seat Height	18%	Arm Height		Weight	188
Depth	29%	Seat Depth	20%	No Arm Cap	22 ³ / ₁₆	Cubic Ft.	56.00
Height	29 ³ / ₁₆	Seat Width	25%	Arm Cap	22 ¹ / ₁₆		
				Arm Width	3 ¹ / ₂		

- Contrasting fabric option – specify X (i.e., K89PE3LCVALUTBX); see page 776. For list pricing, use your electronic specification tool or contact customer service
- Weight Limit 253 lbs.
- Tight-back
- Clean out
- 2mm tubular metal legs
- Non-skid, adjustable glides
- Arm cap on applicable models

TO ORDER, SPECIFY:

1. Model Number
2. Inner Back Upholstery Grade
3. Inner Back Upholstery Number
4. Outer Back Upholstery Grade
5. Outer Back Upholstery Number
6. Seat Upholstery Grade
7. Seat Upholstery Number
8. Arm Upholstery Grade
9. Arm Upholstery Number
10. Front Panel/Accent Upholstery Grade
11. Front Panel/Accent Upholstery Number
12. Leg Metal Finish Designator
13. Moisture Barrier Optional for Seat, or Seat and Inside Back

- See page 775 for Whittaker Health options
- See pages 809-814 for COM fabric yardage

THREE SEAT INTERIOR ARM, PENINSULA LOUNGE

MODEL NO.

ALLIANCE PROGRAM PRICE GRADES

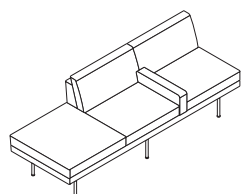

Back on Left Side

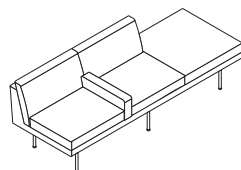

Back on Right Side

			A	B	C	D	E	F	G	H	I
			J	K	L	M	N	O	P	Q	R
K89PE3LILTB	Back on Left Side	\$	5120	5389	5599	5808	6034	6303	6454	6746	6990
			7241	7642	8448	8958	9067	9168	9293	9411	9973
K89PE3RIRTB	Back on Right Side		5120	5389	5599	5808	6034	6303	6454	6746	6990
			7241	7642	8448	8958	9067	9168	9293	9411	9973

DIMENSIONS

Width	86	Seat Height	18 $\frac{1}{2}$	Weight	188
Depth	29 $\frac{3}{4}$	Seat Depth	20 $\frac{1}{16}$	Cubic Ft.	53.00
Height	29 $\frac{13}{16}$	Seat Width	25 $\frac{13}{16}$		

- Contrasting fabric option – specify X (i.e., K89PE3LILTBX); see page 776. For list pricing, use your electronic specification tool or contact customer service
- Weight Limit 253 lbs.
- Tight-back
- Clean out
- 2mm tubular metal legs
- Non-skid, adjustable glides

WHITTAKER HEALTH

TO ORDER, SPECIFY:

1. Model Number
2. Inner Back Upholstery Grade
3. Inner Back Upholstery Number
4. Outer Back Upholstery Grade
5. Outer Back Upholstery Number
6. Seat Upholstery Grade
7. Seat Upholstery Number
8. Front Panel/Accent Upholstery Grade
9. Front Panel/Accent Upholstery Number
10. Leg Metal Finish Designator
11. Moisture Barrier Optional for Seat, or Seat and Inside Back

- See page 775 for Whittaker Health options
- See pages 809-814 for COM fabric yardage

TWO SEAT CORNERS, PENINSULA LOUNGE

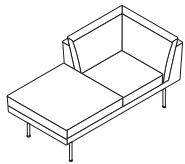

Left Corner

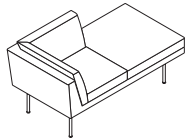

Right Corner

MODEL NO.

ALLIANCE PROGRAM PRICE GRADES

			A	B	C	D	E	F	G	H	I
			J	K	L	M	N	O	P	Q	R
K89CP2LTB	Left Corner	\$	4175	4371	4525	4678	4843	5039	5151	5365	5544
			5728	6022	6612	6986	7066	7139	7232	7318	7728
K89CP2RTB	Right Corner		4175	4371	4525	4678	4843	5039	5151	5365	5544
			5728	6022	6612	6986	7066	7139	7232	7318	7728

DIMENSIONS

Width	57 $\frac{1}{16}$	Seat Height	18 $\frac{1}{16}$	Weight	140
Depth	29 $\frac{3}{16}$	Seat Depth	20 $\frac{1}{16}$	Cubic Ft.	37.00
Height	29 $\frac{13}{16}$	Seat Width	51 $\frac{1}{4}$		

- Contrasting fabric option – specify X (i.e., K89CP2LTBX); see page 776. For list pricing, use your electronic specification tool or contact customer service
- Weight Limit 253 lbs.
- Tight-back
- Clean out
- 2mm tubular metal legs
- Non-skid, adjustable glides

THREE SEAT CORNERS, PENINSULA LOUNGE

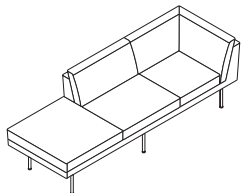

Back on Left Side

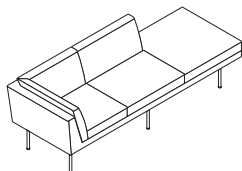

Back on Right Side

			A	B	C	D	E	F	G	H	I
			J	K	L	M	N	O	P	Q	R
K89CP3LTB	Back on Left Side	\$	5408	5681	5893	6105	6335	6606	6759	7057	7303
			7559	7966	8782	9301	9412	9513	9641	9760	10329
K89CP3RTB	Back on Right Side		5408	5681	5893	6105	6335	6606	6759	7057	7303
			7559	7966	8782	9301	9412	9513	9641	9760	10329

DIMENSIONS

Width	84 $\frac{1}{2}$	Seat Height	18 $\frac{1}{16}$	Weight	200
Depth	29 $\frac{3}{16}$	Seat Depth	20 $\frac{1}{16}$	Cubic Ft.	55.00
Height	29 $\frac{13}{16}$	Seat Width	74 $\frac{1}{16}$		

- Contrasting fabric option – specify X (i.e., K89CP3LTBX); see page 776. For list pricing, use your electronic specification tool or contact customer service
- Weight Limit 253 lbs.
- Tight-back
- Clean out
- 2mm tubular metal legs
- Non-skid, adjustable glides

TO ORDER, SPECIFY:

1. Model Number
2. Seat Upholstery Grade
3. Seat Upholstery Number
4. Front Panel/Accent Upholstery Grade
5. Front Panel/Accent Upholstery Number
6. Leg Metal Finish Designator
7. Moisture Barrier Optional for Seat, or Seat and Inside Back

- See page 775 for Whittaker Health options
- See pages 809-814 for COM fabric yardage

BENCHES

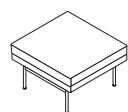

One Seat

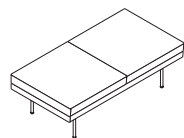

Two Seat

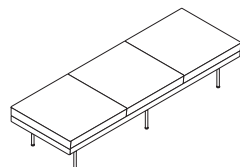

Three Seat

MODEL NO.

ALLIANCE PROGRAM PRICE GRADES

			A	B	C	D	E	F	G	H	I
			J	K	L	M	N	O	P	Q	R
K89BE1	One Seat	\$	1688	1756	1809	1863	1921	1989	2027	2102	2164
			2229	2332	2537	2667	2695	2721	2753	2783	2926
K89BE2	Two Seat		2668	2786	2879	2972	3073	3193	3259	3390	3497
			3609	3787	4145	4372	4419	4465	4520	4572	4821
K89BE3	Three Seat		3382	3548	3678	3807	3948	4114	4207	4388	4539
			4695	4944	5442	5759	5827	5889	5966	6039	6387

DIMENSIONS - ONE SEAT

Width	27½	Weight	58
Depth	28½	Cubic Ft.	11.00
Height	17½		

DIMENSIONS - TWO SEAT

Width	55½	Weight	96
Depth	28½	Cubic Ft.	21.00
Height	17½		

DIMENSIONS - THREE SEAT

Width	82½	Weight	140
Depth	28½	Cubic Ft.	31.00
Height	17½		

- Contrasting fabric option – specify X (i.e., K89BE1X); see page 776. For list pricing, use your electronic specification tool or contact customer service
- Weight Limit 253 lbs.
- 2mm tubular metal legs
- Non-skid, adjustable glides

WHITTAKER HEALTH

TO ORDER, SPECIFY:

• See page 775 for Whittaker Health options

1. Model Number

GANGING DEVICE



MODEL NO.

LIST PRICE

K82PGB	Ganging Device	\$ 49
--------	----------------	-------

DIMENSIONS

Weight	2
Cubic Ft.	1.00

- Two two-piece ganging devices are required to join two units together

POWER/USB MODULE

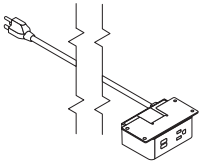

K87EUM	White	\$ 390
--------	-------	--------

DIMENSIONS

Width	4.05
Depth	2.77
Height	1.69

Weight	2
Cubic Ft.	1.00

- Can be placed under all Whittaker lounge models
- 6' cord with three-prong plug
- 1 power receptacle
- 2 USB ports

COM YARDAGE REQUIREMENTS

COM YARDAGE REQUIREMENTS (54" WIDTH – CUT UP THE ROLL)

MODEL	RAILROADED Contact customer service 800-634-9510 for ydg requirements	NON DIRECTIONAL OR SOLID	1"-4" REPEAT	5"-11" REPEAT	12"-18" REPEAT	COL SQUARE FEET
			4" VERTICAL X 4" HORIZONTAL	11" VERTICAL X 11" HORIZONTAL	18" VERTICAL X 18" HORIZONTAL	
K89L1XATB	Entire Unit	3.50	4.50	5.00	6.00	70.3
	Inner Back	1.30	1.80	2.00	2.50	25.5
	Outer Back	1.20	1.50	2.00	2.80	24.4
	Seat	0.90	1.30	2.00	2.00	18.3
	Accent	0.50	1.00	1.50	2.30	10
K89L2XATB	Entire Unit	5.90	7.50	8.50	9.50	118.4
	Inner Back	2.50	3.00	3.50	4.50	49.3
	Outer Back	1.50	2.00	3.00	4.50	29.9
	Seat	1.80	2.00	3.00	3.00	34.9
	Accent	0.60	1.00	1.80	2.80	11.1
K89L3XATB	Entire Unit	9.10	10.50	12.00	14.00	181
	Inner Back	3.70	4.50	5.00	6.50	73.1
	Outer Back	2.20	3.00	4.00	6.00	43.2
	Seat	2.60	3.00	4.00	3.50	51.5
	Accent	0.80	1.50	2.00	3.30	14.9
K89L1CVALUTB, K89L1CVALACWTB, K89L1CVALACPTB, K89L1CVALACTTB, K89L1CVALACSTB	Entire Unit	4.30	5.00	6.00	7.00	84.7
	Inner Back	1.30	1.80	2.00	2.50	25.5
	Outer Back	1.20	1.50	2.00	2.80	24.4
	Seat	0.90	1.30	2.00	2.00	18.3
	Arm	1.40	1.50	1.80	2.50	28.2
	Accent	0.50	1.00	1.50	2.30	10
K89L2CVALUTB, K89L2CVALACWTB, K89L2CVALACPTB, K89L2CVALACTTB, K89L2CVALACSTB	Entire Unit	6.60	8.00	9.00	10.50	132.3
	Inner Back	2.50	3.00	3.50	4.50	49.3
	Outer Back	1.50	2.00	3.00	4.50	29.9
	Seat	1.80	2.00	3.00	3.00	34.9
	Arm	1.30	1.50	1.80	2.50	25.5
	Accent	0.60	1.00	1.80	2.80	11.1
K89L3CVALUTB, K89L3CVALACWTB, K89L3CVALACPTB, K89L3CVALACTTB, K89L3CVALACSTB	Entire Unit	9.60	11.30	12.50	14.50	190.4
	Inner Back	3.60	4.50	5.00	6.50	72.5
	Outer Back	2.10	3.00	4.00	6.00	42.6
	Seat	2.10	3.00	4.00	3.50	41
	Arm	1.30	1.50	1.80	2.50	25.5
	Accent	0.70	1.50	2.00	3.30	14.4
K89L1CVARUTB, K89L1CVARACWTB, K89L1CVARACPTB, K89L1CVARACTTB, K89L1CVARACSTB	Entire Unit	4.30	5.00	6.00	7.00	84.7
	Inner Back	1.30	1.80	2.00	2.50	25.5
	Outer Back	1.20	1.50	2.00	2.80	24.4
	Seat	0.90	1.30	2.00	2.00	18.3
	Arm	1.40	1.50	1.80	2.50	28.2
	Accent	0.50	1.00	1.50	2.30	10
K89L2CVARUTB, K89L2CVARACWTB, K89L2CVARACPTB, K89L2CVARACTTB, K89L2CVARACSTB	Entire Unit	6.60	8.00	9.00	10.50	132.3
	Inner Back	2.50	3.00	3.50	4.50	49.3
	Outer Back	1.50	2.00	3.00	4.50	29.9
	Seat	1.80	2.00	3.00	3.00	34.9
	Arm	1.30	1.50	1.80	2.50	25.5
	Accent	0.60	1.00	1.80	2.80	11.1
K89L3CVARUTB, K89L3CVARACWTB, K89L3CVARACPTB, K89L3CVARACTTB, K89L3CVARACSTB	Entire Unit	9.60	11.30	12.50	14.50	190.4
	Inner Back	3.60	4.50	5.00	6.50	72.5
	Outer Back	2.10	3.00	4.00	6.00	42.6
	Seat	2.10	3.00	4.00	3.50	41
	Arm	1.30	1.50	1.80	2.50	25.5
	Accent	0.70	1.50	2.00	3.30	14.4
K89L1CVABUTB, K89L1CVABACWTB, K89L1CVABACPTB, K89L1CVABACTTB, K89L1CVABACSTB	Entire Unit	5.00	6.00	7.00	8.00	99.1
	Inner Back	1.30	1.80	2.00	2.50	25.5
	Outer Back	1.20	1.50	2.00	2.80	24.4
	Seat	0.90	1.30	2.00	2.00	18.3
	Arms	1.50	2.00	3.00	3.80	30.4
	Accent	0.50	1.00	1.50	2.30	10

WHITTAKER HEALTH

COM YARDAGE REQUIREMENTS

COM YARDAGE REQUIREMENTS (54" WIDTH – CUT UP THE ROLL)

MODEL	RAILROADED Contact customer service 800-634-9510 for ydg requirements	NON DIRECTIONAL OR SOLID	1"-4" REPEAT	5"-11" REPEAT	12"-18" REPEAT	COL SQUARE FEET
			4" VERTICAL X 4" HORIZONTAL	11" VERTICAL X 11" HORIZONTAL	18" VERTICAL X 18" HORIZONTAL	
K89L2CVABUTB,	Entire Unit	7.40	9.00	10.00	11.50	147.2
K89L2CVABACWTB,	Inner Back	2.50	3.00	3.50	4.50	49.2
K89L2CVABACPTB,	Outer Back	1.50	2.00	3.00	4.50	29.9
K89L2CVABACTTB,	Seat	1.80	2.00	3.00	3.00	34.9
K89L2CVABACSTB	Arms	1.50	2.00	3.00	3.80	30.4
	Accent	0.60	1.00	1.80	2.80	11.1
K89L3CVABUTB,	Entire Unit	10.30	12.00	13.50	15.50	204.8
K89L3CVABACWTB,	Inner Back	3.60	4.50	5.00	6.50	72.5
K89L3CVABACPTB,	Outer Back	2.10	3.00	4.00	6.00	42.6
K89L3CVABACTTB,	Seat	2.10	3.00	4.00	3.50	41
K89L3CVABACSTB	Arms	1.50	2.00	3.00	3.80	30.4
	Accent	0.70	1.50	2.00	3.30	14.4
K89L1FALTB, K89L1FARTB	Entire Unit	4.40	5.50	6.50	7.00	88.6
	Inner Back	1.30	1.80	2.00	2.50	25.5
	Outer Back	1.20	1.50	2.00	2.80	24.4
	Seat	0.90	1.30	2.00	2.00	18.3
	Arm	1.40	1.80	2.00	2.50	28.2
	Accent	0.50	1.00	1.50	2.30	10
K89L1FABTB	Entire Unit	5.50	6.50	7.50	8.00	109.6
	Inner Back	1.30	1.80	2.00	2.50	25.5
	Outer Back	1.20	1.50	2.00	2.80	24.4
	Seat	0.90	1.30	2.00	2.00	18.3
	Arms	2.10	2.50	3.30	4.50	41.5
	Accent	0.50	1.00	1.50	2.30	10
K89L2FALTB, K89L2FARTB	Entire Unit	6.90	8.50	10.00	11.00	138.4
	Inner Back	2.50	3.00	3.50	4.50	49.3
	Outer Back	1.50	2.00	3.00	4.50	29.9
	Seat	1.80	2.00	3.00	3.00	34.9
	Arm	1.40	1.80	2.00	2.50	28.2
	Accent	0.60	1.00	1.80	2.80	11.1
K89L2FABTB	Entire Unit	7.90	9.50	11.00	12.00	157.7
	Inner Back	2.50	3.00	3.50	4.50	49.3
	Outer Back	1.50	2.00	3.00	4.50	29.9
	Seat	1.80	2.00	3.00	3.00	34.9
	Arms	2.10	2.50	3.30	4.50	41.5
	Accent	0.60	1.00	1.80	2.80	11.1
K89L3FALTB, K89L3FARTB	Entire Unit	9.80	12.00	13.00	15.00	195.9
	Inner Back	3.60	4.50	5.00	6.50	72.5
	Outer Back	2.10	3.00	4.00	6.00	42.6
	Seat	2.10	3.00	4.00	3.50	41
	Arm	1.40	1.80	2.00	2.50	28.2
	Accent	0.70	1.50	2.00	3.30	14.4
K89L3FABTB	Entire Unit	10.80	13.00	14.50	16.50	215.3
	Inner Back	3.60	4.50	5.00	6.50	72.5
	Outer Back	2.10	3.00	4.00	6.00	42.6
	Seat	2.10	3.00	4.00	3.50	41
	Arms	2.10	2.50	3.30	4.50	41.5
	Accent	0.70	1.50	2.00	3.30	14.4
K89L2XAIBT	Entire Unit	5.10	7.50	8.50	10.50	101.8
	Inner Back	2.50	3.00	3.50	4.50	49.3
	Outer Back	1.50	2.00	3.00	4.50	29.9
	Seat	1.50	2.00	3.00	3.00	30.4
	Arm	1.20	1.40	1.50	2.00	24.4
	Accent	0.60	1.00	1.80	2.80	11.1
K89L3XAIBT, K89L3XAIRTB	Entire Unit	10.10	10.50	12.00	14.50	202
	Inner Back	2.10	3.00	4.00	3.50	41
	Outer Back	2.10	3.00	4.00	6.00	42.6
	Seat	2.10	3.00	4.00	3.50	41
	Arm	1.20	1.40	1.50	2.00	24.4
	Accent	0.70	1.50	2.00	3.30	14.4

COM YARDAGE REQUIREMENTS

COM YARDAGE REQUIREMENTS (54" WIDTH – CUT UP THE ROLL)

MODEL	RAILROADED Contact customer service 800-634-9510 for ydg requirements	NON DIRECTIONAL OR SOLID	1"-4" REPEAT	5"-11" REPEAT	12"-18" REPEAT	COL SQUARE FEET
			4" VERTICAL X 4" HORIZONTAL	11" VERTICAL X 11" HORIZONTAL	18" VERTICAL X 18" HORIZONTAL	
K89L3XAIBTB	Entire Unit	10.10	11.00	12.50	15.50	202
	Inner Back	3.60	4.50	5.00	6.50	72.5
	Outer Back	2.10	3.00	4.00	6.00	42.6
	Seat	2.10	3.00	4.00	3.50	41
	Arm	1.20	1.50	2.50	2.80	24.4
	Accent	0.70	1.50	2.00	3.30	14.4
K89L2CVALIUTB, K89L2CVALIACWTB, K89L2CVALIACPTB, K89L2CVALIACSTB	Entire Unit	5.90	8.00	9.00	11.50	117.3
	Inner Back	2.50	3.00	3.50	4.50	49.3
	Outer Back	1.50	2.00	3.00	4.50	29.9
	Seat	1.80	2.00	3.00	3.00	34.9
	Arms	1.40	1.80	2.50	3.00	28.2
	Accent	0.60	1.00	1.80	2.80	11.1
K89L2CVARIUTB, K89L2CVARIACWTB, K89L2CVARIACPTB, K89L2CVARIACSTB	Entire Unit	5.90	8.00	9.00	11.50	117.3
	Inner Back	2.50	3.00	3.50	4.50	49.3
	Outer Back	1.50	2.00	3.00	4.50	29.9
	Seat	1.80	2.00	3.00	3.00	34.9
	Arms	1.40	1.80	2.50	3.00	28.2
	Accent	0.60	1.00	1.80	2.80	11.1
K89L2CVABIUTB, K89L2CVABIACWTB, K89L2CVABIACPTB, K89L2CVABIACSTB	Entire Unit	6.60	9.00	10.50	12.50	130.6
	Inner Back	2.50	3.00	3.50	4.50	49.3
	Outer Back	1.50	2.00	3.00	4.50	29.9
	Seat	1.80	2.00	3.00	3.00	34.9
	Arms	1.70	2.50	4.50	5.00	33.2
	Accent	0.60	1.00	1.80	2.80	11.1
K89L3CVARILUTB, K89L3CVARILACWTB, K89L3CVARILACPTB, K89L3CVARILACTTB, K89L3CVARILACSTB	Entire Unit	8.70	11.30	13.00	15.50	173.8
	Inner Back	3.60	4.50	5.00	6.50	72.5
	Outer Back	2.10	3.00	4.00	6.00	42.6
	Seat	2.10	3.00	4.00	3.50	41
	Arms	1.30	1.80	2.50	3.00	25.5
	Accent	0.70	1.50	2.00	3.30	14.4
K89L3CVABILUTB, K89L3CVABILACWTB, K89L3CVABILACPTB, K89L3CVABILACTTB, K89L3CVABILACSTB	Entire Unit	9.40	12.50	14.00	16.50	188.2
	Inner Back	3.60	4.50	5.00	6.50	72.5
	Outer Back	2.10	3.00	4.00	6.00	42.6
	Seat	2.10	3.00	4.00	3.50	41
	Arms	1.70	2.50	4.50	5.00	33.2
	Accent	0.70	1.50	2.00	3.30	14.4
K89L3CVALIRUTB, K89L3CVALIRACWTB, K89L3CVALIRACPTB, K89L3CVALIRACTTB, K89L3CVALIRACSTB	Entire Unit	8.70	11.30	13.00	15.50	173.8
	Inner Back	3.60	4.50	5.00	6.50	72.5
	Outer Back	2.10	3.00	4.00	6.00	42.6
	Seat	2.10	3.00	4.00	3.50	41
	Arms	1.30	1.80	2.50	3.00	25.5
	Accent	0.70	1.50	2.00	3.30	14.4
K89L3CVABIRUTB, K89L3CVABIRACWTB, K89L3CVABIRACPTB, K89L3CVABIRACTTB, K89L3CVABIRACSTB	Entire Unit	9.40	12.50	14.00	16.50	188.2
	Inner Back	3.60	4.50	5.00	6.50	72.5
	Outer Back	2.10	3.00	4.00	6.00	42.6
	Seat	2.10	3.00	4.00	3.50	41
	Arms	1.70	2.50	4.50	5.00	33.2
	Accent	0.70	1.50	2.00	3.30	14.4
K89L3CVARIBUTB, K89L3CVARIBACWTB, K89L3CVARIBACPTB, K89L3CVARIBACTTB, K89L3CVARIBACSTB	Entire Unit	8.00	11.50	13.50	16.30	159.4
	Inner Back	3.60	4.50	5.00	6.50	72.5
	Outer Back	2.10	3.00	4.00	6.00	42.6
	Seat	2.10	3.00	4.00	3.50	41
	Arms	1.90	3.00	4.50	5.00	38.7
	Accent	0.70	1.50	2.00	3.30	14.4
K89L3CVALIBUTB, K89L3CVALIBACWTB, K89L3CVALIBACPTB, K89L3CVALIBACTTB, K89L3CVALIBACSTB	Entire Unit	8.00	11.50	13.50	16.30	159.4
	Inner Back	3.60	4.50	5.00	6.50	72.5
	Outer Back	2.10	3.00	4.00	6.00	42.6
	Seat	2.10	3.00	4.00	3.50	41
	Arms	1.90	3.00	4.50	5.00	38.7
	Accent	0.70	1.50	2.00	3.30	14.4

COM YARDAGE REQUIREMENTS

COM YARDAGE REQUIREMENTS (54" WIDTH – CUT UP THE ROLL)

MODEL	RAILROADED Contact customer service 800-634-9510 for ydg requirements	NON DIRECTIONAL OR SOLID	1"-4" REPEAT	5"-11" REPEAT	12"-18" REPEAT	COL SQUARE FEET
			4" VERTICAL X 4" HORIZONTAL	11" VERTICAL X 11" HORIZONTAL	18" VERTICAL X 18" HORIZONTAL	
K89L3CVABIBUTB,	Entire Unit	8.60	12.50	15.00	17.50	171.6
K89L3CVABIBACWTB,	Inner Back	3.60	4.50	5.00	6.50	72.5
K89L3CVABIBACPTB,	Outer Back	2.10	3.00	4.00	6.00	42.6
K89L3CVABIBACTTB,	Seat	2.10	3.00	4.00	3.50	41
K89L3CVABIBACSTB	Arms	1.90	3.00	4.50	5.00	38.7
	Accent	0.70	1.50	2.00	3.30	14.4
K89C2LXATB	Entire Unit	6.20	8.50	10.50	12.50	123.4
	Inner Back	3.00	4.50	5.00	6.00	59.8
	Outer Back	2.20	2.80	4.00	5.30	43.2
	Seat	1.60	2.00	2.50	2.50	32.1
	Accent	0.50	1.00	1.50	2.30	10
K89C3LXATB	Entire Unit	9.30	12.00	14.00	16.50	184.8
	Inner Back	3.10	3.80	5.80	6.50	75.8
	Outer Back	2.90	3.50	5.00	7.30	57
	Seat	2.30	2.80	4.00	3.50	45.9
	Accent	0.60	1.00	1.80	2.80	11.6
K89C2LCVAUTB,	Entire Unit	6.90	9.00	11.00	13.00	137.3
K89C2LCVAACWTB,	Inner Back	3.00	4.50	5.00	6.00	59.8
K89C2LCVAACPTB,	Outer Back	2.20	2.80	4.00	5.30	43.2
K89C2LCVAACTTB,	Seat	1.60	2.00	2.50	2.50	32.1
K89C2LCVAACSTB	Arm	1.30	1.50	1.80	2.50	25.5
	Accent	0.50	1.00	1.50	2.30	10
K89C3LCVAUTB,	Entire Unit	9.80	12.50	14.50	17.50	194.3
K89C3LCVAACWTB,	Inner Back	3.80	5.80	6.50	7.50	75.8
K89C3LCVAACPTB,	Outer Back	2.90	3.50	5.00	7.30	57
K89C3LCVAACTTB,	Seat	2.30	2.80	4.00	3.50	45.9
K89C3LCVAACSTB	Arm	1.30	1.50	1.80	2.50	25.5
	Accent	0.60	1.00	1.80	2.80	11.6
K89C2LFATB	Entire Unit	7.20	9.50	11.50	13.50	142.8
	Inner Back	3.00	4.50	5.00	6.00	59.8
	Outer Back	2.20	2.80	4.00	5.30	43.2
	Seat	1.60	2.00	2.50	2.50	32.1
	Arm	1.40	1.80	2.00	2.50	28.2
	Accent	0.50	1.00	1.50	2.30	10
K89C3LFATB	Entire Unit	10.10	13.00	15.50	17.50	200.9
	Inner Back	3.80	5.80	6.50	7.50	75.8
	Outer Back	2.90	3.50	5.00	7.30	57
	Seat	2.30	2.80	4.00	3.50	45.9
	Arm	1.40	1.80	2.00	2.50	28.2
	Accent	0.60	1.00	1.80	2.80	11.6
K89C3LXAIRTB	Entire Unit	8.30	12.00	14.00	17.00	164.9
	Inner Back	3.80	5.80	6.50	7.50	75.8
	Outer Back	2.90	3.50	5.00	7.30	57
	Seat	2.30	2.80	4.00	3.50	45.9
	Arm	1.20	1.40	1.50	2.00	12.2
	Accent	0.60	1.00	1.80	2.80	11.6
K89C3LCVAUIRTB,	Entire Unit	9.20	13.00	15.00	18.00	182.6
K89C3LCVAACWIRTB,	Inner Back	3.80	5.80	6.50	7.50	75.8
K89C3LCVAACPRTB,	Outer Back	2.90	3.50	5.00	7.30	57
K89C3LCVAACIRTB,	Seat	2.30	2.80	4.00	3.50	45.9
K89C3LCVAACSIRTB	Arms	1.30	1.80	2.50	3.00	25.5
	Accent	0.60	1.00	1.80	2.80	11.6
K89C2RXATB	Entire Unit	6.20	8.50	10.50	12.50	123.4
	Inner Back	3.00	4.50	5.00	6.00	59.8
	Outer Back	2.20	2.80	4.00	5.30	43.2
	Seat	1.60	2.00	2.50	2.50	32.1
	Accent	0.50	1.00	1.50	2.30	10
K89C3RXATB	Entire Unit	9.30	12.00	14.00	16.50	184.8
	Inner Back	3.10	3.80	5.80	6.50	75.8
	Outer Back	2.90	3.50	5.00	7.30	57
	Seat	2.30	2.80	4.00	3.50	45.9
	Accent	0.60	1.00	1.80	2.80	11.6

COM YARDAGE REQUIREMENTS

COM YARDAGE REQUIREMENTS (54" WIDTH – CUT UP THE ROLL)

MODEL	RAILROADED Contact customer service 800-634-9510 for ydg requirements	NON DIRECTIONAL OR SOLID	1"-4" REPEAT	5"-11" REPEAT	12"-18" REPEAT	COL SQUARE FEET
			4" VERTICAL X 4" HORIZONTAL	11" VERTICAL X 11" HORIZONTAL	18" VERTICAL X 18" HORIZONTAL	
K89C2RCVAUTB,	Entire Unit	6.90	9.00	11.00	13.00	137.3
K89C2RCVAACWTB,	Inner Back	3.00	4.50	5.00	6.00	59.8
K89C2RCVAACPTB,	Outer Back	2.20	2.80	4.00	5.30	43.2
K89C2RCVAACCTB,	Seat	1.60	2.00	2.50	2.50	32.1
K89C2RCVAACSTB	Arm	1.30	1.50	1.80	2.50	25.5
	Accent	0.50	1.00	1.50	2.30	10
K89C3RCVAUTB,	Entire Unit	9.80	12.50	14.50	17.50	194.3
K89C3RCVAACWTB,	Inner Back	3.80	5.80	6.50	7.50	75.8
K89C3RCVAACPTB,	Outer Back	2.90	3.50	5.00	7.30	57
K89C3RCVAACCTB,	Seat	2.30	2.80	4.00	3.50	45.9
K89C3RCVAACSTB	Arm	1.30	1.50	1.80	2.50	25.5
	Accent	0.60	1.00	1.80	2.80	11.6
K89C2RFATB	Entire Unit	7.20	9.50	11.50	13.50	142.8
	Inner Back	3.00	4.50	5.00	6.00	59.8
	Outer Back	2.20	2.80	4.00	5.30	43.2
	Seat	1.60	2.00	2.50	2.50	32.1
	Arm	1.40	1.80	2.00	2.50	28.2
	Accent	0.50	1.00	1.50	2.30	10
K89C3RFATB	Entire Unit	10.10	13.00	15.50	17.50	200.9
	Inner Back	3.80	5.80	6.50	7.50	75.8
	Outer Back	2.90	3.50	5.00	7.30	57
	Seat	2.30	2.80	4.00	3.50	45.9
	Arm	1.40	1.80	2.00	2.50	28.2
	Accent	0.60	1.00	1.80	2.80	11.6
K89C3RXAILTB	Entire Unit	8.30	12.00	14.00	17.00	164.9
	Inner Back	3.80	5.80	6.50	7.50	75.8
	Outer Back	2.90	3.50	5.00	7.30	57
	Seat	2.30	2.80	4.00	3.50	45.9
	Arm	1.20	1.40	1.50	2.00	12.2
	Accent	0.60	1.00	1.80	2.80	11.6
K89C3RCVAUILTB,	Entire Unit	9.20	13.00	15.00	18.00	182.6
K89C3RCVAACWILTB,	Inner Back	3.80	5.80	6.50	7.50	75.8
K89C3RCVAACPILTB,	Outer Back	2.90	3.50	5.00	7.30	57
K89C3RCVAACITLTB,	Seat	2.30	2.80	4.00	3.50	45.9
K89C3RCVAACSILTB	Arms	1.30	1.80	2.50	3.00	25.5
	Accent	0.60	1.00	1.80	2.80	11.6
K89PE2LTB, K89PE2RTB	Entire Unit	5.20	6.00	7.00	8.00	103.5
	Inner Back	1.30	1.80	2.00	2.50	25.5
	Outer Back	1.20	1.50	2.00	2.80	24.4
	Seat	2.10	2.50	3.30	3.30	41.5
	Accent	0.90	1.50	2.00	3.30	18.8
K89PE3LTB, K89PE3RTB	Entire Unit	7.60	9.00	10.50	12.00	152.2
	Inner Back	2.50	3.00	3.50	4.30	49.3
	Outer Back	1.50	2.00	3.00	4.30	29.9
	Seat	2.90	3.30	4.50	4.50	57.6
	Accent	1.10	1.50	2.30	3.80	22.1
K89PE2RCVARUTB,	Entire Unit	5.90	7.00	8.00	9.00	117.3
K89PE2RCVARACWTB,	Inner Back	1.30	1.80	2.00	2.50	25.5
K89PE2RCVARACPTB,	Outer Back	1.20	1.50	2.00	2.80	24.4
K89PE2RCVARACTTB,	Seat	2.10	2.50	3.30	3.30	41.5
K89PE2RCVARACSTB	Arm	1.30	1.50	1.80	2.50	25.5
	Accent	0.90	1.50	2.00	3.30	18.8
K89PE3RCVARUTB,	Entire Unit	8.40	10.00	11.00	13.00	166.6
K89PE3RCVARACWTB,	Inner Back	2.50	3.00	3.50	4.30	49.3
K89PE3RCVARACPTB,	Outer Back	1.50	2.00	3.00	4.30	29.9
K89PE3RCVARACTTB,	Seat	2.90	3.30	4.50	4.50	57.6
K89PE3RCVARACSTB	Arms	1.30	1.50	1.80	2.50	25.5
	Accent	1.10	1.50	2.30	3.80	22.1

WHITTAKER HEALTH

COM YARDAGE REQUIREMENTS

COM YARDAGE REQUIREMENTS (54" WIDTH – CUT UP THE ROLL)

MODEL	RAILROADED Contact customer service 800-634-9510 for ydg requirements	NON DIRECTIONAL OR SOLID	1"-4" REPEAT	5"-11" REPEAT	12"-18" REPEAT	COL SQUARE FEET
			4" VERTICAL X 4" HORIZONTAL	11" VERTICAL X 11" HORIZONTAL	18" VERTICAL X 18" HORIZONTAL	
K89PE2LCVALUTB,	Entire Unit	5.90	7.00	8.00	9.00	117.3
K89PE2LCVALACWTB,	Inner Back	1.30	1.80	2.00	2.50	25.5
K89PE2LCVALACPTB,	Outer Back	1.20	1.50	2.00	2.80	24.4
K89PE2LCVALACCTB,	Seat	2.10	2.50	3.30	3.30	41.5
K89PE2LCVALACSTB	Arm	1.30	1.50	1.80	2.50	25.5
	Accent	0.90	1.50	2.00	3.30	18.8
K89PE3LCVALUTB,	Entire Unit	8.40	10.00	11.00	13.00	166.6
K89PE3LCVALACWTB,	Inner Back	2.50	3.00	3.50	4.30	49.3
K89PE3LCVALACPTB,	Outer Back	1.50	2.00	3.00	4.30	29.9
K89PE3LCVALACCTB,	Seat	2.90	3.30	4.50	4.50	57.6
K89PE3LCVALACSTB	Arms	1.30	1.50	1.80	2.50	25.5
	Accent	1.10	1.50	2.30	3.80	22.1
K89PE3LILTB, K89PE3LIRTB	Entire Unit	7.00	9.00	11.00	13.50	139.5
	Inner Back	2.50	3.00	3.50	4.30	49.3
	Outer Back	1.50	2.00	3.00	4.30	29.9
	Seat	2.10	3.30	4.50	4.50	41.5
	Arm	1.20	1.40	1.50	2.00	12.2
	Accent	1.10	1.50	2.30	3.80	22.1
K89CP2LTB, K89CP2RTB	Entire Unit	5.00	7.00	9.00	10.00	99.1
	Inner Back	2.00	3.00	3.50	4.30	40.4
	Outer Back	1.50	2.00	3.00	4.30	29.3
	Seat	1.90	2.50	2.80	2.80	38.2
	Accent	0.70	1.30	1.80	2.80	14.4
K89CP3LTB, K89CP3RTB	Entire Unit	8.20	10.50	12.50	14.50	163.3
	Inner Back	3.00	4.30	4.80	5.80	59.8
	Outer Back	2.20	2.80	3.00	5.80	43.2
	Seat	2.60	3.30	4.00	4.00	52
	Accent	0.70	1.80	2.30	3.80	14.4
K89BE1	Entire Unit	2.00	2.40	3.00	4.50	40.4
	Seat	1.30	1.50	2.30	2.30	24.9
	Accent	0.90	1.20	1.80	2.80	17.7
K89BE2	Entire Unit	3.60	4.00	5.00	7.00	70.8
	Seat	2.40	2.70	3.80	4.00	47
	Accent	1.40	1.60	2.30	4.00	27.1
K89BE3	Entire Unit	5.10	5.80	6.80	9.50	101.3
	Seat	3.50	3.80	5.00	5.30	69.7
	Accent	1.70	2.00	3.00	5.00	33.8