Pairings Health

Product Specifications	484
Fabrics and Options	485
Contrasting Fabrics Specifications	488
Product Pages	490
COM Yardage Requirements	502

PAIRINGS HEALTH

PAIRINGS HEALTH PRODUCT SPECIFICATIONS

FRAME CONSTRUCTION

- Frame is constructed of plywood, using a lap-joint construction method
- Frames are glued and screwed

SEAT CONSTRUCTION

- Seats feature a high tension, strip webbing suspension that is stapled to the frame
- Seat upholstery features a wrap-around upholstery method and is stapled into place
- Clean out design allows for easy clean up of debris or liquids
- Clean out space does not detract from the aesthetic or function of the lounge

CUSHIONS

- Cushions are made of high grade, high resiliency, CFC-free, laminated polyurethane foam
- Seat cushions are 2¾" thick
- Back cushions are 2" thick and upholstered using the slipcover method and finished with French seams:
 - Double stitch seams in center (27" wide segments)
 - Single French seams at sides of lounge to create double stitch appearance when joined with other lounge units

CONTRASTING FABRIC

- Contrasting fabric may be specified for back, seat, and arms.
- While seat and back upholstery will align on a unit, there is no guarantee that individual models will align when attached to each other
- Fabrics reflect light differently when viewed at various angles, creating a natural phenomenon called "flip." Flip is visible on all fabrics and is not considered a defect; it is more easily recognized on fabrics with a nap or shimmer

ARMS

- Arm tops and outside panels feature ¾"-thick, high grade polyurethane foam
- Arms feature a sewn slipcover with French seams that is stapled into place

TABLETS

- Available as an option in 3D laminate, HPL with a phenolic core, or wood. They swivel 360 degrees

HANDING DESIGNATION (LEFT OR RIGHT OF UNIT)

- Determined from the user's perspective when seated

POWER/USB

- Power/USB modules are available on left, right, or left and right kickrail as well as left, right, or left and right front of arm on 8". See page 487

LEGS

- Legs are 9¼" high and available in two shapes:
 - Metal spider leg
 - Round wood leg (upcharge applies)
- Non-skid, adjustable glides are 2" in diameter

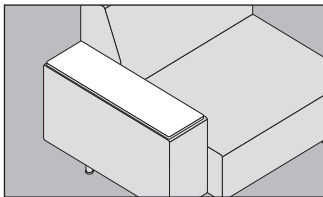
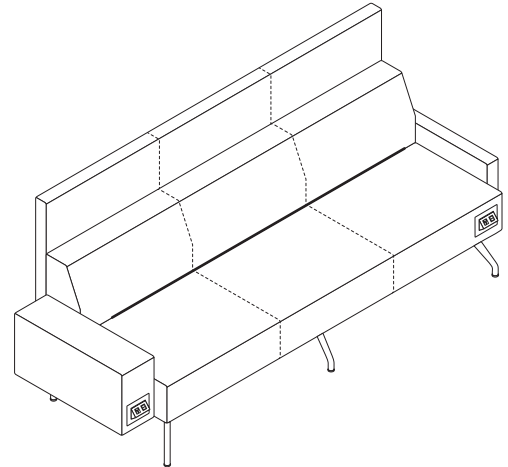

Arm caps

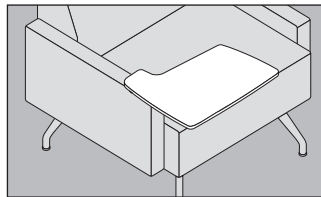

Tablet arms

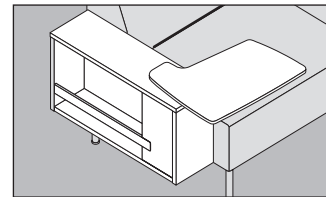

Storage tablet arm

FABRIC APPLICATION DIAGRAMS

90° CORNERS:

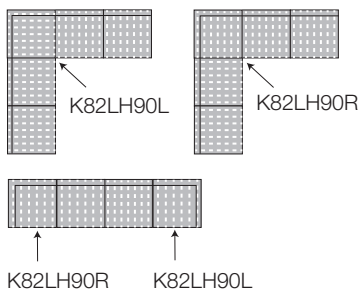

CORNER BENCHES:

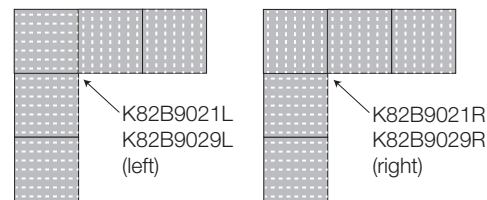

SURFACE MATERIALS

See the Kimball Hospitality Surface Materials Reference Guide at kimballhospitality.com for a complete overview of our materials program, including:

- Characteristics of wood
- Special wood finishes
- Customer specified laminate (CSL)
- Customer specified paint (CSP)
- Fabric application and colorways
- Customer's own material (COM) process overview
- Alliance program

ALLIANCE FABRIC PROGRAM

Kimball Hospitality has analyzed each model to most accurately reflect the COM/COL yardage requirements shown on page 502.

The yardage requirement for each model is based on 54" wide fabric and cutting the fabric up the roll.

If repeat is larger than 18", contact Customer Service to confirm the correct amount of yardage required. When ordering 10 or more chairs in the same COM, yardage requirements may be reduced.

Contact Customer Service.

PRICE GRADES A-R

See Surface Materials at www.kimballhospitality.com for a wide variety of graded-in fabrics from Arc-Com, Carnegie, CF Stinson, Designtex, Maharam, Mayer, Momentum, and Ultrafabrics.

FABRIC SAMPLES

If you need samples for presentation(s), contact our alliance partners directly at:

Arc-Com	800.223.5466	arc-com.com
Carnegie	800.727.6770	carnegiefabrics.com
CF Stinson	800.841.6279	cfstinson.com
Designtex	800.221.1540	designtex.com
Maharam	800.645.3943	maharam.com
Mayer	800.428.4415	mayerfabrics.com
Momentum	800.366.6839	memosamples.com
Ultrafabrics	877.309.6648	ultrafabricsllc.com

ARM CAPS

3D LAMINATE

WOODGRAIN

CO	Canyon
DF	Driftwood
MH	Mocha
YO	Monterey
NW	Tuscan

SOLID COLOR

462	Cinder
405	Designer White
450	Fog

SOLID SURFACE

STANDARD

7101	Bisque
405	Designer White

PREMIUM*

467	Carbon Concrete
468	Neutral Concrete
464	Peace Grey
469	Weathered Concrete

*Upcharge applies

WOOD

BZ	Brazilwood	MH	Mocha
CO	Canyon	YO	Monterey
CI	Chai	PC	Porcini
CC	Cordoba	PB	Portobello
DF	Driftwood	792	Sable
KN	Kona	NW	Tuscan
MW	Midtown	WL	Willow

TABLET TOPS

3D LAMINATE

WOODGRAIN

MC	Amber Cherry
MH	Mocha Cherry
CO	Canyon Straight Grain
DF	Driftwood Straight Grain
YO	Monterey Straight Grain
NW	Tuscan Straight Grain

SOLID

462	Cinder
405	Designer White
450	Fog

TABLET TABLET

HIGH PRESSURE LAMINATE (HPL)

WOODGRAIN

BZ	Brazilwood	PC	Porcini
CO	Canyon	PB	Portobello
CI	Chai	792	Sable
DF	Driftwood	NW	Tuscan
KN	Kona	WL	Willow
YO	Monterey		

SOLID COLOR

462	Cinder
440	Cloud
457	Dapple
405	Designer White

LEGS

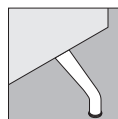

SPIDER LEG W/METAL FINISH

No designator
(No upcharge)

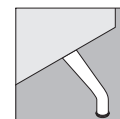

SPIDER LEG W/PAINT FINISH

No Designator
(+\$138 per model)

FINISHES

494	Brushed Aluminum
497	Polished Aluminum

For spider leg option, simply specify the finish number.

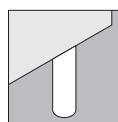

ROUND LEG

Designator = R
(+\$138 per model)

WOOD

AD	Almond	MW	Midtown
MC	Amber	MH	Mocha
BZ	Brazilwood	YO	Monterey
IM	Brighton	PC	Porcini
CO	Canyon	PB	Portobello
CI	Chai	792	Sable
CC	Cordoba	SC	Sedona
DF	Driftwood	TW	Tribeca
ES	Espresso	NW	Tuscan
TN	Huntington	UW	Urban
KN	Kona	WL	Willow

For round leg option, specify the leg designator and finish designator together in one step.

Examples:

RMC = Round wood leg in Amber
RUW = Round wood leg in Urban

GROUP 1 PAINT FINISHES

48	Antique White	488	Frosty White
427	Barley	456	Granite
437	Cement	461	Graphite
403	Chamois	445	Moon Beam
462	Cinder	416	Putty
440	Cloud	420	Sandstone
457	Dapple	425	Shadow
485	Dark Chocolate	465	Smoke
405	Designer White	460	Storm
453	Environmental Grey	429	Tantalum
459	Featherstone	419	Wallaby
450	Fog		

GROUP 21 PAINT FINISHES

111	Apricot Orange	109	Fossil
103	Chive	113	Golden Rod
106	Cloud Blue	110	Silver Mink
107	Dark Blue	105	Spinach Green
102	Drizzle	112	Tango Red

GROUP M PAINT FINISHES

514	Carbon Metallic
547	Dark Bronze Metallic
507	Patina Metallic
501	Platinum Metallic
505	Satin Bronze Metallic
544	Silver Pearl
504	Taupe Metallic

For spider leg option, simply specify the finish number.

IMPORTANT: Hardwood finishes on seating are complementary to veneer finishes on casegoods and tables, but may not be a direct match due to the difference in substrates.

Contact Customer Service for more information

PAIRINGS HEALTH

ARM CAPS

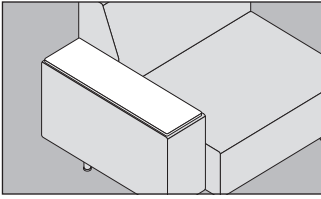

Arm cap substitution, when desired, must be made for each arm, and *must be the same* on both arms for models with arms on both sides.

For example:
K82L32LAU2RAUPFB would become K82L32LAW2RAWPFB to add wood arm caps on both arms.

IMPORTANT: Upcharges listed are per arm.

Handing designation (left or right of unit) is determined from the user's perspective when seated

TABLET ARMS

Tablet arm substitution is available on select models. See individual pricing page for availability by model

Tablet arms are available on both arms of two and three seat models with 8" arms only; tablet materials must match

Tablet arm/arm cap combinations are only available in the combinations at below and at right

Tablet arms are mounted to upholstered arms

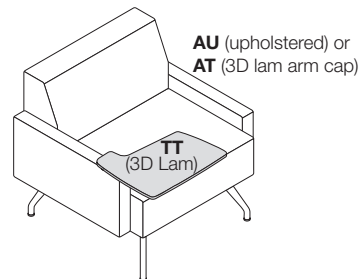
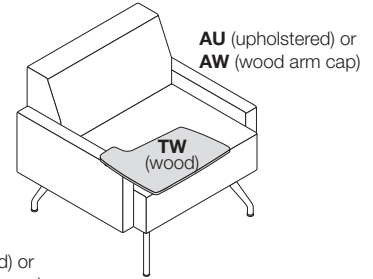
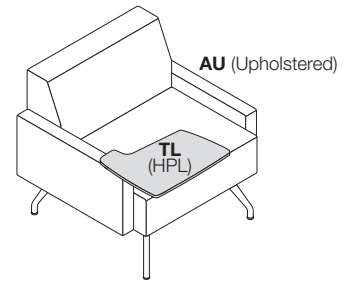

HOW TO SPECIFY

DESCRIPTION	HOW TO SPECIFY	ON 2" ARM (PER ARM)	ON 8" ARM (PER ARM)
ARM CAPS			
3D laminate arm cap	Substitute AT for AU in model	+\$61	+\$75
Wood arm cap	Substitute AW for AU in model	+\$95	+\$114
Solid surface arm cap	Substitute AS for AU in model	+\$123	+\$154
TABLET ARMS			
3D laminate tablet	Substitute TT for AU in model	+\$136	+\$168
HPL tablet with phenolic core	Substitute TL for AU in model	+\$382	+\$475
Wood tablet	Substitute TW for AU in model	+\$398	+\$490

FACTORY-INSTALLED POWER/USB OPTIONS FOR LOUNGE SEATING

KICKRAIL POWER/USB:

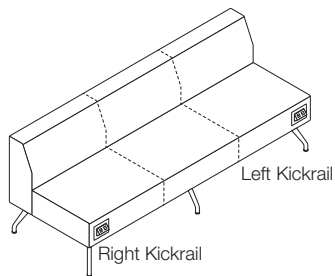
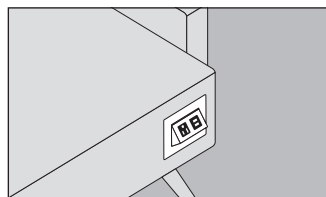

ARM POWER/USB:

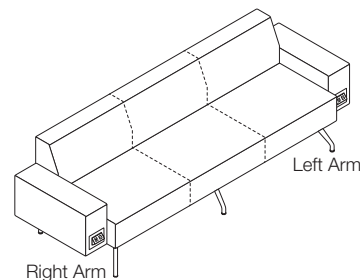
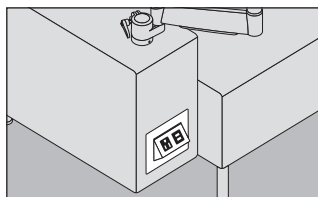

HOW TO SPECIFY

1. Insert the power module designator in applicable step in the model number sequence

LOCATION	OPTION DESIGNATORS	OPTION DESIGNATORS	UPCHARGE
	KICK RAIL POWER/USB	8" ARM POWER/USB	
Left front (as seated)	G55KRPL	G55APL	+\$539
	G56KRPL	G56APL	+\$576
Right front (as seated)	G55KRPR	G55APR	+\$539
	G56KRPR	G56APR	+\$576
Left and right front (as seated)	G55KRPLR	G55APLR	+\$1078
	G56KRPLR	G56APLR	+\$1152

IMPORTANT: Specify based on connector type, cord length and circuit configuration:

- G55** 6' cord with three-prong plug
- G56** 10' cord with three-prong plug

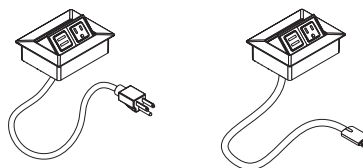

Power/USB modules feature a single-sided, pneumatic pop-out. Actual cut-out size is for 4" x 5". Modules are painted in platinum metallic

Handing designation (left or right of unit) is determined from the user's perspective when seated

TO ORDER CONTRASTING FABRIC, SPECIFY

PAIRINGS HEALTH

Armless Lounge page 490

Corner & Crescent page 498

1. Model Number plus "X"
2. Back Fabric Grade
3. Back Fabric Number
4. Seat Fabric Grade
5. Seat Fabric Number
6. Kickrail Power/USB Option
7. Leg Option



Contrasting Fabric may be specified on seat and back

One Seat Lounge, 2" Arms page 491

Two Seat Lounge 2" Arms page 495

Three Seat Lounge 2" Arms page 497

1. Model Number plus "X"
2. Back Fabric Grade
3. Back Fabric Number
4. Seat Fabric Grade
5. Seat Fabric Number
6. Arm Fabric Grade
7. Arm Fabric Number
8. Arm Cap or Tablet Arm Finish Price Group (if applicable)
9. Arm Cap or Tablet Arm Finish Designator (if applicable)
10. Kickrail Power/USB Option
11. Leg Option



Contrasting Fabric may be specified on seat, back, and arm

One Seat Lounge 8" Arms page 492

Two Seat Lounge 8" Arms page 496

1. Model Number plus "X"
2. Back Fabric Grade
3. Back Fabric Number
4. Seat Fabric Grade
5. Seat Fabric Number
6. Arm Fabric Grade
7. Arm Fabric Number
8. Arm Cap or Tablet Arm Finish Price Group (if applicable)
9. Arm Cap or Tablet Arm Finish Designator (if applicable)
10. Kickrail Power/USB Option
11. Arm Power/USB Option
12. Leg Option



Contrasting Fabric may be specified on seat, back, and arm

One Seat Lounge TFL Storage Tablet Arm Left or Right page 493

1. Model Number plus "X"
2. Back Fabric Grade
3. Back Fabric Number
4. Seat Fabric Grade
5. Seat Fabric Number
6. Tablet HPL or Wood Price Group
7. Tablet Finish Designator
8. Storage TFL Designator
9. Kickrail Power/USB Option
10. Arm Power/USB Option
11. Leg Option



Contrasting Fabric may be specified on seat, back, and arm

One Seat Lounge Wood Storage Tablet Arm Left or Right page 494

1. Model Number plus "X"
2. Back Fabric Grade
3. Back Fabric Number
4. Seat Fabric Grade
5. Seat Fabric Number
6. Tablet HPL Price Group (HPL only)
7. Tablet Finish Designator (3D laminate and HPL only)
8. Storage Wood Price Group
9. Storage Wood Designator
10. Kickrail Power/USB Option
11. Arm Power/USB Option
12. Leg Option



Contrasting Fabric may be specified on seat, back, and arm

PAIRINGS HEALTH

TO ORDER, SPECIFY

1. Model Number
2. Back Fabric Grade
3. Back Fabric Number
4. Seat Fabric Grade
5. Seat Fabric Number
6. Kickrail Power/USB Option
7. Leg Option

• See pages 485-487 for Pairings Health options
 See pages 502-519 for COM fabric yardage

ARMLESS LOUNGE

MODEL NO.

ALLIANCE PROGRAM PRICE GRADES



One Seat

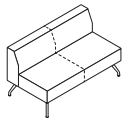

Two Seat

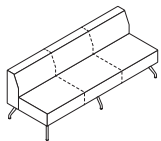

Three Seat

			A	B	C	D	E	F	G	H	I
			J	K	L	M	N	O	P	Q	R
K82LH1	One Seat	\$	2620	2750	2850	2953	3064	3194	3268	3409	3527
			3649	3844	4233	4482	4537	4584	4644	4704	4977
K82LH2	Two Seat		3644	3851	4011	4175	4352	4559	4677	4902	5090
			5285	5597	6217	6613	6701	6777	6872	6967	7403
K82LH3	Three Seat		5092	5396	5631	5875	6136	6440	6614	6944	7223
			7510	7971	8885	9467	9598	9711	9850	9989	10633

DIMENSIONS - ONE SEAT

Width	27	Seat Height	18	Weight	38.50
Depth	29	Seat Depth	21	Cubic Ft.	13.50
Height	30	Seat Width	27		

DIMENSIONS - TWO SEAT

Width	54	Seat Height	18	Weight	60.20
Depth	29	Seat Depth	21	Cubic Ft.	36.50
Height	30	Seat Width	54		

DIMENSIONS - THREE SEAT

Width	81	Seat Height	18	Weight	85.70
Depth	29	Seat Depth	21	Cubic Ft.	54.20
Height	30	Seat Width	81		

- Contrasting fabric option – specify X (i.e., K82LH1X); see page 488. For list pricing, use your electronic specification tool or contact customer service
- Kickrail power/USB
- Leg options

TO ORDER, SPECIFY

1. Model Number
2. Back Fabric Grade
3. Back Fabric Number
4. Seat Fabric Grade
5. Seat Fabric Number
6. Arm Fabric Grade
7. Arm Fabric Number
8. Arm Cap or Tablet Arm Finish Price Group (if applicable)
9. Arm Cap or Tablet Arm Finish Designator (if applicable)
10. Kickrail Power/USB Option
11. Leg Option

- See pages 485-487 for Pairings Health options
- See pages 502-519 for COM fabric yardage

**ONE SEAT LOUNGE
2" ARMS**



Left Arm



Right Arm



Left and Right Arms

**MODEL
NO.**

ALLIANCE PROGRAM PRICE GRADES

		A	B	C	D	E	F	G	H	I
		J	K	L	M	N	O	P	Q	R
K82LH12LAU	2" Arm Left	\$ 3132	3297	3424	3555	3696	3861	3955	4134	4284
		4439	4687	5181	5497	5567	5627	5703	5779	6126
K82LH12RAU	2" Arm Right	3132	3297	3424	3555	3696	3861	3955	4134	4284
		4439	4687	5181	5497	5567	5627	5703	5779	6126
K82LH12LAU2RAU	2" Arms Left and Right	3632	3828	3980	4136	4304	4500	4612	4825	5004
		5189	5485	6073	6449	6533	6605	6695	6785	7199

DIMENSIONS

Width - L or R	29	Seat Height	18	Arm Height	22	Weight - L or R	38.50
Width - L and R	31	Seat Depth	21	Arm Depth	26	Weight - L and R	49.70
Depth	29	Seat Width	27	Arm Width	2	Cubic Ft. - L or R	13.50
Height	30					Cubic Ft. - L and R	14.70

- Contrasting fabric option – specify X (i.e., K82LH12LAUX); see page 488. For list pricing, use your electronic specification tool or contact customer service
- Arm options
- Kickrail power/USB
- Leg options

PAIRINGS HEALTH

TO ORDER, SPECIFY

1. Model Number
2. Back Fabric Grade
3. Back Fabric Number
4. Seat Fabric Grade
5. Seat Fabric Number
6. Arm Fabric Grade
7. Arm Fabric Number
8. Arm Cap or Tablet Arm Finish Price Group (if applicable)
9. Arm Cap or Tablet Arm Finish Designator (if applicable)
10. Kickrail Power/USB Option
11. Arm Power/USB Option
12. Leg Option

• See pages 485-487 for Pairings Health options
See pages 502-519 for COM fabric yardage

ONE SEAT LOUNGE 8" ARMS



Left Arm



Right Arm



Left and Right Arms

MODEL NO.

ALLIANCE PROGRAM PRICE GRADES

			A	B	C	D	E	F	G	H	I
			J	K	L	M	N	O	P	Q	R
K82LH18LAU	8" Arm Left	\$	3234	3399	3526	3657	3798	3963	4057	4236	4386
			4541	4789	5283	5599	5669	5729	5805	5881	6228
K82LH18RAU	8" Arm Right		3234	3399	3526	3657	3798	3963	4057	4236	4386
			4541	4789	5283	5599	5669	5729	5805	5881	6228
K82LH18LAU8RAU	8" Arms Left and Right		3836	4032	4184	4340	4508	4704	4816	5029	5208
			5393	5689	6277	6653	6737	6809	6899	6989	7403

DIMENSIONS

Width - L or R	35	Seat Height	18	Arm Height	22	Weight - L or R	50.50
Width - L and R	43	Seat Depth	21	Arm Depth	26	Weight - L and R	59.00
Depth	29	Seat Width	27	Arm Width	8	Cubic Ft. - L or R	15.10
Height	30					Cubic Ft. - L and R	17.00

- Contrasting fabric option – specify X (i.e., K82LH18LAUX); see page 488. For list pricing, use your electronic specification tool or contact customer service
- Arm options
- Kickrail power/USB
- Arm Power/USB
- Leg options

TO ORDER, SPECIFY

1. Model Number
2. Back Fabric Grade
3. Back Fabric Number
4. Seat Fabric Grade
5. Seat Fabric Number
6. Tablet HPL or Wood Price Group
(omit for 3D laminate)
7. Tablet Finish Designator
8. Storage TFL Designator
9. Kickrail Power/USB Option
10. Arm Power/USB Option
11. Leg Option

• See pages 485-487 for Pairings Health options
See pages 502-519 for COM fabric yardage

**ONE SEAT LOUNGE
TFL STORAGE
TABLET ARM LEFT**



3D Laminate Tablet



HPL Tablet with Phenolic Core



Wood Tablet

**MODEL
NO.**

ALLIANCE PROGRAM PRICE GRADES

			A	B	C	D	E	F	G	H	I
			J	K	L	M	N	O	P	Q	R
K82LH18LTLLS	3D Laminate Tablet	\$	4425	4555	4655	4758	4869	4999	5073	5214	5332
			5454	5649	6038	6287	6342	6389	6449	6509	6782
K82LH18LTLLS	HPL Tablet with Phenolic Core		4737	4867	4967	5070	5181	5311	5385	5526	5644
			5766	5961	6350	6599	6654	6701	6761	6821	7094
K82LH18LTWLLS	Wood Tablet		4754	4884	4984	5087	5198	5328	5402	5543	5661
			5783	5978	6367	6616	6671	6718	6778	6838	7111

DIMENSIONS

Width	37	Seat Height	18	Arm Height	22	Weight	48.60
Depth	29	Seat Depth	21	Arm Depth	26	Cubic Ft.	15.10
Height	30	Seat Width	27	Arm Width	8		

- Contrasting fabric option – specify X (i.e., K82LH18LTLLSX); see page 489. For list pricing, use your electronic specification tool or contact customer service
- Kickrail power/USB
- Arm power/USB
- Leg options

**ONE SEAT LOUNGE
TFL STORAGE
TABLET ARM RIGHT**



3D Laminate Tablet

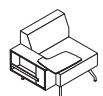

HPL Tablet with Phenolic Core



Wood Tablet

			A	B	C	D	E	F	G	H	I
			J	K	L	M	N	O	P	Q	R
K82LH18RTLLS	3D Laminate Tablet	\$	4425	4555	4655	4758	4869	4999	5073	5214	5332
			5454	5649	6038	6287	6342	6389	6449	6509	6782
K82LH18RTLLS	HPL Tablet with Phenolic Core		4737	4867	4967	5070	5181	5311	5385	5526	5644
			5766	5961	6350	6599	6654	6701	6761	6821	7094
K82LH18RTWLLS	Wood Tablet		4754	4884	4984	5087	5198	5328	5402	5543	5661
			5783	5978	6367	6616	6671	6718	6778	6838	7111

DIMENSIONS

Width	37	Seat Height	18	Arm Height	22	Weight	48.60
Depth	29	Seat Depth	21	Arm Depth	26	Cubic Ft.	15.10
Height	30	Seat Width	27	Arm Width	8		

- Contrasting fabric option – specify X (i.e., K82LH18RTLLSX); see page 489. For list pricing, use your electronic specification tool or contact customer service
- Kickrail power/USB
- Arm power/USB
- Leg options

PAIRINGS HEALTH

TO ORDER, SPECIFY

1. Model Number
2. Back Fabric Grade
3. Back Fabric Number
4. Seat Fabric Grade
5. Seat Fabric Number
6. Tablet HPL Price Group (HPL only)
7. Tablet Finish Designator (3D laminate and HPL only)
8. Storage Wood Price Group
9. Storage Wood Designator
10. Kickrail Power/USB Option
11. Arm Power/USB Option
12. Leg Option

• See pages 485-487 for Pairings Health options

See pages 502-519 for COM fabric yardage

ONE SEAT LOUNGE WOOD STORAGE TABLET ARM LEFT



3D Laminate Tablet



HPL Tablet with Phenolic Core



Wood Tablet

MODEL NO.

ALLIANCE PROGRAM PRICE GRADES

			A	B	C	D	E	F	G	H	I
			J	K	L	M	N	O	P	Q	R
K82LH18LTTWS	3D Laminate Tablet	\$	4580	4710	4810	4913	5024	5154	5228	5369	5487
			5609	5804	6193	6442	6497	6544	6604	6664	6937
K82LH18LTLWS	HPL Tablet with Phenolic Core		4893	5023	5123	5226	5337	5467	5541	5682	5800
			5922	6117	6506	6755	6810	6857	6917	6977	7250
K82LH18LTWWS	Wood Tablet		4910	5040	5140	5243	5354	5484	5558	5699	5817
			5939	6134	6523	6772	6827	6874	6934	6994	7267

DIMENSIONS

Width	37	Seat Height	18	Arm Height	22	Weight	48.60
Depth	29	Seat Depth	21	Arm Depth	26	Cubic Ft.	15.10
Height	30	Seat Width	27	Arm Width	8		

- Contrasting fabric option – specify X (i.e., K82LH18LTLWSX); see page 489. For list pricing, use your electronic specification tool or contact customer service
- Kickrail power/USB
- Arm power/USB
- Leg options

ONE SEAT LOUNGE WOOD STORAGE TABLET ARM RIGHT



3D Laminate Tablet



HPL Tablet with Phenolic Core



Wood Tablet

			A	B	C	D	E	F	G	H	I
			J	K	L	M	N	O	P	Q	R
K82LH18RTTWS	3D Laminate Tablet	\$	4580	4710	4810	4913	5024	5154	5228	5369	5487
			5609	5804	6193	6442	6497	6544	6604	6664	6937
K82LH18RTLWS	HPL Tablet with Phenolic Core		4893	5023	5123	5226	5337	5467	5541	5682	5800
			5922	6117	6506	6755	6810	6857	6917	6977	7250
K82LH18RTWWS	Wood Tablet		4910	5040	5140	5243	5354	5484	5558	5699	5817
			5939	6134	6523	6772	6827	6874	6934	6994	7267

DIMENSIONS

Width	37	Seat Height	18	Arm Height	22	Weight	48.60
Depth	29	Seat Depth	21	Arm Depth	26	Cubic Ft.	15.10
Height	30	Seat Width	27	Arm Width	8		

- Contrasting fabric option – specify X (i.e., K82LH18RTTWSX); see page 489. For list pricing, use your electronic specification tool or contact customer service
- Kickrail power/USB
- Arm power/USB
- Leg options

TO ORDER, SPECIFY

1. Model Number
2. Back Fabric Grade
3. Back Fabric Number
4. Seat Fabric Grade
5. Seat Fabric Number
6. Arm Fabric Grade
7. Arm Fabric Number
8. Arm Cap or Tablet Arm Finish Price Group (if applicable)
9. Arm Cap or Tablet Arm Finish Designator (if applicable)
10. Kickrail Power/USB Option
11. Leg Option

• See pages 485-487 for Pairings Health options
 See pages 502-519 for COM fabric yardage

**TWO SEAT LOUNGE
 2" ARMS**

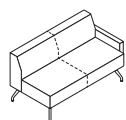

Left Arm

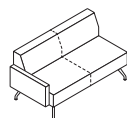

Right Arm

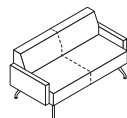

Left and Right Arms

**MODEL
 NO.**

ALLIANCE PROGRAM PRICE GRADES

			A	B	C	D	E	F	G	H	I
			J	K	L	M	N	O	P	Q	R
K82LH22LAU	2" Arm Left	\$	4154	4396	4583	4775	4982	5224	5362	5625	5845
			6073	6438	7163	7626	7729	7818	7929	8040	8550
K82LH22RAU	2" Arm Right		4154	4396	4583	4775	4982	5224	5362	5625	5845
			6073	6438	7163	7626	7729	7818	7929	8040	8550
K82LH22LAU2RAU	2" Arms Left and Right		4659	4932	5144	5361	5595	5868	6024	6321	6570
			6828	7241	8060	8583	8700	8801	8926	9051	9628

DIMENSIONS

Width - L or R	56	Seat Height	18	Arm Height	22	Weight - L or R	65.80
Width - L and R	58	Seat Depth	21	Arm Depth	26	Weight - L and R	71.40
Depth	29	Seat Width	54	Arm Width	2	Cubic Ft. - L or R	38.50
Height	30					Cubic Ft. - L and R	40.40

- Contrasting fabric option – specify X (i.e., K82LH22LAUX); see page 488. For list pricing, use your electronic specification tool or contact customer service
- Arm options
- Kickrail power/USB
- Leg options

PAIRINGS HEALTH

TO ORDER, SPECIFY

1. Model Number
2. Back Fabric Grade
3. Back Fabric Number
4. Seat Fabric Grade
5. Seat Fabric Number
6. Arm Fabric Grade
7. Arm Fabric Number
8. Arm Cap or Tablet Arm Finish Price Group (if applicable)
9. Arm Cap or Tablet Arm Finish Designator (if applicable)
10. Kickrail Power/USB Option
11. Arm Power/USB Option
12. Leg Option

• See pages 485-487 for Pairings Health options
See pages 502-519 for COM fabric yardage

TWO SEAT LOUNGE 8" ARMS

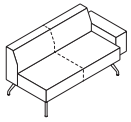

Left Arm

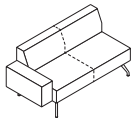

Right Arm

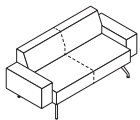

Left and Right Arms

MODEL NO.

ALLIANCE PROGRAM PRICE GRADES

			A	B	C	D	E	F	G	H	I
			J	K	L	M	N	O	P	Q	R
K82LH28LAU	8" Arm Left	\$	4256	4498	4685	4877	5084	5326	5464	5727	5947
			6175	6540	7265	7728	7831	7920	8031	8142	8652
K82LH28RAU	8" Arm Right		4256	4498	4685	4877	5084	5326	5464	5727	5947
			6175	6540	7265	7728	7831	7920	8031	8142	8652
K82LH28LAU8RAU	8" Arms Left and Right		4862	5135	5347	5564	5798	6071	6227	6524	6773
			7031	7444	8263	8786	8903	9004	9129	9254	9831

DIMENSIONS

Width - L or R	62	Seat Height	18	Arm Height	22	Weight - L or R	69.80
Width - L and R	70	Seat Depth	21	Arm Depth	26	Weight - L and R	79.40
Depth	29	Seat Width	54	Arm Width	8	Cubic Ft. - L or R	41.70
Height	30					Cubic Ft. - L and R	46.80

- Contrasting fabric option – specify X (i.e., K82LH28LAUX); see page 488. For list pricing, use your electronic specification tool or contact customer service
- Arm options
- Kickrail power/USB
- Arm power/USB
- Leg options

TO ORDER, SPECIFY

1. Model Number
2. Back Fabric Grade
3. Back Fabric Number
4. Seat Fabric Grade
5. Seat Fabric Number
6. Arm Fabric Grade
7. Arm Fabric Number
8. Arm Cap or Tablet Arm Finish Price Group (if applicable)
9. Arm Cap or Tablet Arm Finish Designator (if applicable)
10. Kickrail Power/USB Option
11. Leg Option

• See pages 485-487 for Pairings Health options
See pages 502-519 for COM fabric yardage

**THREE SEAT LOUNGE
2" ARMS**

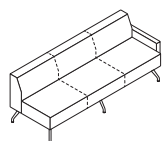

Left Arm

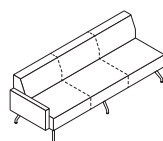

Right Arm

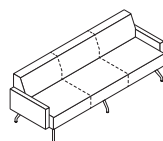

Left and Right Arms

**MODEL
NO.**

ALLIANCE PROGRAM PRICE GRADES

			A	B	C	D	E	F	G	H	I
			J	K	L	M	N	O	P	Q	R
K82LH32LAU	2" Arm Left	\$	5602	5941	6203	6475	6766	7105	7299	7667	7978
			8298	8812	9831	10480	10626	10752	10907	11062	11780
K82LH32RAU	2" Arm Right		5602	5941	6203	6475	6766	7105	7299	7667	7978
			8298	8812	9831	10480	10626	10752	10907	11062	11780
K82LH32LAU2RAU	2" Arms Left and Right		6107	6477	6764	7061	7379	7749	7961	8363	8703
			9053	9615	10728	11437	11597	11735	11904	12073	12858

DIMENSIONS

Width - L or R	83	Seat Height	18	Arm Height	22	Weight - L or R	91.30
Width - L and R	85	Seat Depth	21	Arm Depth	26	Weight - L and R	96.90
Depth	29	Seat Width	81	Arm Width	2	Cubic Ft. - L or R	56.20
Height	30					Cubic Ft. - L and R	58.10

- Contrasting fabric option – specify X (i.e., K82LH32LAUX); see page 488. For list pricing, use your electronic specification tool or contact customer service
- Arm options
- Kickrail power/USB
- Leg options

**THREE SEAT LOUNGE
8" ARMS**

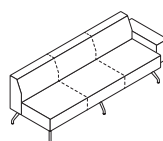

Left Arm

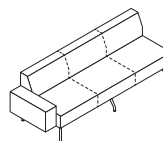

Right Arm

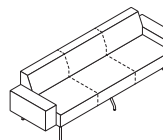

Left and Right Arms

			A	B	C	D	E	F	G	H	I
			J	K	L	M	N	O	P	Q	R
K82LH38LAU	8" Arm Left	\$	5703	6042	6304	6576	6867	7206	7400	7768	8079
			8399	8913	9932	10581	10727	10853	11008	11163	11881
K82LH38RAU	8" Arm Right		5703	6042	6304	6576	6867	7206	7400	7768	8079
			8399	8913	9932	10581	10727	10853	11008	11163	11881
K82LH38LAU8RAU	8" Arms Left and Right		6308	6678	6965	7262	7580	7950	8162	8564	8904
			9254	9816	10929	11638	11798	11936	12105	12274	13059

DIMENSIONS

Width - L or R	89	Seat Height	18	Arm Height	22	Weight - L or R	95.30
Width - L and R	97	Seat Depth	21	Arm Depth	26	Weight - L and R	104.90
Depth	29	Seat Width	81	Arm Width	2	Cubic Ft. - L or R	59.40
Height	30					Cubic Ft. - L and R	64.50

- Contrasting fabric option – specify X (i.e., K82LH38LAUX); see page 488. For list pricing, use your electronic specification tool or contact customer service
- Arm options
- Kickrail power/USB
- Leg options

PAIRINGS HEALTH

TO ORDER, SPECIFY

1. Model Number
2. Back Fabric Grade
3. Back Fabric Number
4. Seat Fabric Grade
5. Seat Fabric Number
6. Kickrail Power/USB Option (omit for corner)
7. Leg Option

• See pages 485-487 for Pairings Health options
See pages 502-519 for COM fabric yardage

CORNERS & CRESCENTS LOUNGE

MODEL NO.

ALLIANCE PROGRAM PRICE GRADES



90° Corner Left (as seated)



90° Corner Right (as seated)

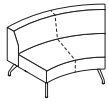

45° Crescent

			A	B	C	D	E	F	G	H	I
			J	K	L	M	N	O	P	Q	R
K82LH90L	90° Corner Left (as seated)	\$	2780	2886	2968	3053	3144	3250	3310	3425	3523
			3623	3783	4101	4304	4350	4389	4437	4486	4710
K82LH90R	90° Corner Right (as seated)		2780	2886	2968	3053	3144	3250	3310	3425	3523
			3623	3783	4101	4304	4350	4389	4437	4486	4710
K82LH45	45° Crescent		3489	3649	3772	3900	4038	4198	4290	4464	4611
			4762	5005	5485	5792	5861	5921	5994	6067	6405

DIMENSIONS - CORNER

Width	29	Seat Height	18	Weight	48.80
Depth	29	Seat Depth	21	Cubic Ft.	20.50
Height	30	Seat Width	29		

DIMENSIONS - CRESCENT

Width	54	Seat Height	18	Weight	77.30
Depth	29	Seat Depth	21	Cubic Ft.	40.90
Height	30	Seat Width	54		

- Corner and crescent lounge models coordinate with Pairings Health lounge models, but do not feature a clean-out.
- Can be used in conjunction with Kimball Pairings benches, tables, and perch models.
- Contrasting fabric option – specify X (i.e., K82LH90LX); see page 488. For list pricing, use your electronic specification tool or contact customer service
- No clean out
- Kickrail power/USB on crescent
- Leg options
- IMPORTANT: Fabrics reflect light differently when viewed at various angles, creating a natural phenomenon called "flip." Flip is visible on all fabrics and is not considered a defect; it is more easily recognized on fabrics with a nap or shimmer and more apparent on crescent or corner units

TO ORDER, SPECIFY

1. Model Number
2. Fabric Grade
3. Fabric Number
4. Kickrail Power/USB Option
5. Leg Option

• See pages 485-487 for Pairings Health options
 See pages 502-519 for COM fabric yardage

**BENCH
21" DEEP**



One Seat

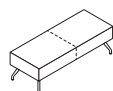

Two Seat

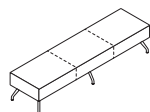

Three Seat

**MODEL
NO.**

ALLIANCE PROGRAM PRICE GRADES

				A	B	C	D	E	F	G	H	I
				J	K	L	M	N	O	P	Q	R
K82BH121	One Seat	\$	2082	2134	2174	2216	2260	2312	2342	2399	2447	
			2496	2575	2731	2831	2853	2872	2896	2920	3030	
K82BH221	Two Seat	2666	2761	2834	2910	2991	3086	3140	3243	3330		
		3420	3563	3848	4030	4070	4105	4149	4192	4393		
K82BH321	Three Seat	3447	3588	3696	3808	3928	4068	4148	4301	4429		
		4561	4773	5194	5462	5523	5575	5639	5703	5999		

DIMENSIONS - ONE SEAT

Width	27	Seat Height	18	Weight	
Depth	21	Seat Depth	21	Cubic Ft.	
Height	18	Seat Width	27		

DIMENSIONS - TWO SEAT

Width	54	Seat Height	18	Weight	
Depth	21	Seat Depth	21	Cubic Ft.	
Height	18	Seat Width	54		

DIMENSIONS - THREE SEAT

Width	81	Seat Height	18	Weight	
Depth	21	Seat Depth	21	Cubic Ft.	
Height	18	Seat Width	81		

- Kickrail power/USB
- Leg options

**BENCH
29" DEEP**



One Seat

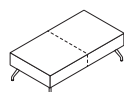

Two Seat

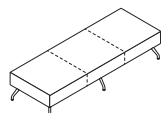

Three Seat

				A	B	C	D	E	F	G	H	I
				J	K	L	M	N	O	P	Q	R
K82BH129	One Seat	\$	2264	2345	2407	2471	2540	2620	2666	2753	2826	
			2902	3024	3265	3418	3453	3483	3519	3556	3726	
K82BH229	Two Seat	2935	3065	3165	3269	3380	3510	3584	3725	3844		
		3967	4163	4553	4802	4857	4905	4965	5024	5299		
K82BH329	Three Seat	3625	3811	3954	4103	4262	4448	4554	4756	4926		
		5101	5383	5940	6296	6376	6445	6530	6615	7008		

DIMENSIONS - ONE SEAT

Width	27	Seat Height	18	Weight	
Depth	29	Seat Depth	21	Cubic Ft.	
Height	18	Seat Width	27		

DIMENSIONS - TWO SEAT

Width	54	Seat Height	18	Weight	
Depth	29	Seat Depth	21	Cubic Ft.	
Height	18	Seat Width	54		

DIMENSIONS - THREE SEAT

Width	81	Seat Height	18	Weight	
Depth	29	Seat Depth	21	Cubic Ft.	
Height	18	Seat Width	81		

- Kickrail power/USB
- Leg options

PAIRINGS HEALTH

TO ORDER, SPECIFY

1. Model Number
2. Fabric Grade
3. Fabric Number
4. Leg Option

• See pages 485-487 for Pairings Health options
 See pages 502-519 for COM fabric yardage

90° CORNER BENCH



21" Deep



29" Deep

MODEL NO.

ALLIANCE PROGRAM PRICE GRADES

			A	B	C	D	E	F	G	H	I
			J	K	L	M	N	O	P	Q	R
K82BH9021L	21" Deep, Left (as seated)	\$	1900	1946	1981	2018	2057	2103	2129	2179	2221
			2264	2334	2471	2559	2579	2596	2617	2638	2735
K82BH9021R	21" Deep, Right (as seated)		1900	1946	1981	2018	2057	2103	2129	2179	2221
			2264	2334	2471	2559	2579	2596	2617	2638	2735
K82BH9029L	29" Deep, Left (as seated)		2519	2603	2667	2734	2806	2890	2938	3029	3105
			3184	3311	3563	3723	3759	3790	3828	3867	4044
K82BH9029R	29" Deep, Right (as seated)		2519	2603	2667	2734	2806	2890	2938	3029	3105
			3184	3311	3563	3723	3759	3790	3828	3867	4044

DIMENSIONS - 21" DEEP

Width	21	Seat Height	18	Weight
Depth	21	Seat Depth	21	Cubic Ft.
Height	18	Seat Width	21	

DIMENSIONS - 29" DEEP

Width	29	Seat Height	18	Weight
Depth	29	Seat Depth	29	Cubic Ft.
Height	18	Seat Width	29	

- Kickrail power/USB
- Leg options

TO ORDER, SPECIFY

1. Model Number
2. Fabric Grade
3. Fabric Number
4. Kickrail Power/USB option
5. Leg Option

• See pages 485-487 for Pairings Health options
 See pages 502-519 for COM fabric yardage

45° CRESCENT BENCH

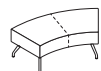

21" Deep

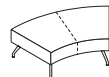

29" Deep

MODEL NO.

ALLIANCE PROGRAM PRICE GRADES

	MODEL NO.	SEAT DEPTH		A	B	C	D	E	F	G	H	I
				J	K	L	M	N	O	P	Q	R
K82BH4521	21" Deep		\$	2871	2942	2996	3052	3112	3182	3222	3299	3363
				3429	3535	3746	3880	3911	3937	3969	4001	4149
K82BH4529	29" Deep			3660	3744	3808	3875	3947	4031	4079	4170	4246
				4325	4452	4704	4864	4900	4931	4969	5008	5185

DIMENSIONS - 21" DEEP

Width	54	Seat Height	18	Weight	
Depth	21	Seat Depth	21	Cubic Ft.	
Height	18	Seat Width	54		

DIMENSIONS - 29" DEEP

Width	54	Seat Height	18	Weight	
Depth	29	Seat Depth	29	Cubic Ft.	
Height	18	Seat Width	54		

- Kickrail power/USB
- Leg options

COM YARDAGE REQUIREMENTS

COM YARDAGE REQUIREMENTS (54" WIDTH – CUT UP THE ROLL)

MODEL	RAILROADED Contact customer service 800-634-9510 for ydg requirements	NON DIRECTIONAL OR SOLID	1"-4" REPEAT	5"-11" REPEAT	12"-18" REPEAT	COL SQUARE FEET
			4" VERTICAL X 4" HORIZONTAL	11" VERTICAL X 11" HORIZONTAL	18" VERTICAL X 18" HORIZONTAL	
K82BH121	Entire Unit	1.40	1.90	2.10	3.20	28
K82BH129	Entire Unit	2.20	2.50	3.60	3.60	44
K82BH221	Entire Unit	2.60	2.90	4.50	4.70	52
K82BH229	Entire Unit	3.60	4.00	5.10	5.80	72
K82BH321	Entire Unit	3.50	3.90	5.10	5.70	70
K82BH329	Entire Unit	5.10	5.50	7.40	7.80	102
K82BH4521	Entire Unit	2.20	2.50	3.60	3.60	44
K82BH4529	Entire Unit	1.80	2.00	3.90	4.30	40
K82BH9021D	Entire Unit	1.30	1.50	2.10	3.20	26
K82BH9021L	Entire Unit	1.10	1.30	2.10	3.20	22
K82BH9021R	Entire Unit	1.10	1.30	2.10	3.20	22
K82BH9029D	Entire Unit	2.40	2.80	3.90	4.30	47.5
K82BH9029L	Entire Unit	2.20	2.50	3.60	3.60	44
K82BH9029R	Entire Unit	2.20	2.50	3.60	3.60	44
K82LH1	Entire Unit	2.50	3.10	3.90	4.80	49
	Back	1.40	1.70	2.10	3.30	28
	Seat	1.20	1.70	2.40	3.20	21.5
K82LH12LAP	Entire Unit	3.90	4.50	4.70	4.90	75.5
	Back	1.60	1.80	1.90	2.00	30.5
	Seat	2.10	2.40	2.50	2.60	38.2
	Arm	1.00	1.20	1.20	1.30	20
K82LH12LAP2RAP	Entire Unit	4.70	5.40	5.60	5.90	91.5
	Back	1.60	1.80	1.90	2.00	30.5
	Seat	2.10	2.40	2.50	2.60	38.2
	Arm	1.80	2.10	2.20	2.30	34
K82LH12LAS	Entire Unit	3.90	4.50	4.70	4.90	75.5
	Back	1.60	1.80	1.90	2.00	30.5
	Seat	2.10	2.40	2.50	2.60	38.2
	Arm	1.00	1.20	1.20	1.30	20
K82LH12LAS2RAS	Entire Unit	4.70	5.40	5.60	5.90	91.5
	Back	1.60	1.80	1.90	2.00	30.5
	Seat	2.10	2.40	2.50	2.60	38.2
	Arm	1.80	2.10	2.20	2.30	34
K82LH12LASTRAS	Entire Unit	4.80	5.50	5.80	6.00	94
	Back	1.60	1.80	1.90	2.00	30.5
	Seat	2.10	2.40	2.50	2.60	38.2
	Arm	1.90	2.20	2.30	2.40	38
K82LH12LAT	Entire Unit	3.90	4.50	4.70	4.90	75.5
	Back	1.60	1.80	1.90	2.00	30.5
	Seat	2.10	2.40	2.50	2.60	38.2
	Arm	1.00	1.20	1.20	1.30	20
K82LH12LAT2RAT	Entire Unit	4.70	5.40	5.60	5.90	91.5
	Back	1.60	1.80	1.90	2.00	30.5
	Seat	2.10	2.40	2.50	2.60	38.2
	Arm	1.80	2.10	2.20	2.30	34
K82LH12LAT2RTT	Entire Unit	4.70	5.40	5.60	5.90	91.5
	Back	1.60	1.80	1.90	2.00	30.5
	Seat	2.10	2.40	2.50	2.60	38.2
	Arm	1.80	2.10	2.20	2.30	34
K82LH12LATTRAT	Entire Unit	4.80	5.50	5.80	6.00	94
	Back	1.60	1.80	1.90	2.00	30.5
	Seat	2.10	2.40	2.50	2.60	38.2
	Arm	1.90	2.20	2.30	2.40	38
K82LH12LATTRLLS	Entire Unit	3.90	4.50	4.70	4.90	75.5
	Back	1.60	1.80	1.90	2.00	30.5
	Seat	2.10	2.40	2.50	2.60	38.2
	Arm	1.00	1.20	1.20	1.30	20

COM YARDAGE REQUIREMENTS

COM YARDAGE REQUIREMENTS (54" WIDTH – CUT UP THE ROLL)

MODEL	RAILROADED Contact customer service 800-634-9510 for ydg requirements	NON DIRECTIONAL OR SOLID	1"-4" REPEAT	5"-11" REPEAT	12"-18" REPEAT	COL SQUARE FEET
			4" VERTICAL X 4" HORIZONTAL	11" VERTICAL X 11" HORIZONTAL	18" VERTICAL X 18" HORIZONTAL	
K82LH12LAU	Entire Unit	3.90	4.50	4.70	4.90	75.5
	Back	1.60	1.80	1.90	2.00	30.5
	Seat	2.10	2.40	2.50	2.60	38.2
	Arm	1.00	1.20	1.20	1.30	20
K82LH12LAU2RAU	Entire Unit	4.80	5.50	5.80	6.00	92
	Back	1.60	1.80	1.90	2.00	30.5
	Seat	2.10	2.40	2.50	2.60	38.2
	Arm	1.90	2.20	2.30	2.40	36
K82LH12LAU2RTL	Entire Unit	4.80	5.50	5.80	6.00	92
	Back	1.60	1.80	1.90	2.00	30.5
	Seat	2.10	2.40	2.50	2.60	38.2
	Arm	1.90	2.20	2.30	2.40	36
K82LH12LAU2RTT	Entire Unit	4.80	5.50	5.80	6.00	92
	Back	1.60	1.80	1.90	2.00	30.5
	Seat	2.10	2.40	2.50	2.60	38.2
	Arm	1.90	2.20	2.30	2.40	36
K82LH12LAU2RTW	Entire Unit	4.80	5.50	5.80	6.00	92
	Back	1.60	1.80	1.90	2.00	30.5
	Seat	2.10	2.40	2.50	2.60	38.2
	Arm	1.90	2.20	2.30	2.40	36
K82LH12LAW	Entire Unit	3.90	4.50	4.70	4.90	75.5
	Back	1.60	1.80	1.90	2.00	30.5
	Seat	2.10	2.40	2.50	2.60	38.2
	Arm	1.00	1.20	1.20	1.30	20
K82LH12LAW2RAW	Entire Unit	4.70	5.40	5.60	5.90	91.5
	Back	1.60	1.80	1.90	2.00	30.5
	Seat	2.10	2.40	2.50	2.60	38.2
	Arm	1.80	2.10	2.20	2.30	34
K82LH12LAW2RTW	Entire Unit	4.70	5.40	5.60	5.90	91.5
	Back	1.60	1.80	1.90	2.00	30.5
	Seat	2.10	2.40	2.50	2.60	38.2
	Arm	1.80	2.10	2.20	2.30	34
K82LH12LAWTRAW	Entire Unit	4.80	5.50	5.80	6.00	94
	Back	1.60	1.80	1.90	2.00	30.5
	Seat	2.10	2.40	2.50	2.60	38.2
	Arm	1.90	2.20	2.30	2.40	38
K82LH12LAWTRWS	Entire Unit	3.90	4.50	4.70	4.90	75.5
	Back	1.60	1.80	1.90	2.00	30.5
	Seat	2.10	2.40	2.50	2.60	38.2
	Arm	1.00	1.20	1.20	1.30	20
K82LH12LTL	Entire Unit	3.90	4.50	4.70	4.90	75.5
	Back	1.60	1.80	1.90	2.00	30.5
	Seat	2.10	2.40	2.50	2.60	38.2
	Arm	1.00	1.20	1.20	1.30	20
K82LH12LTL2RAU	Entire Unit	4.80	5.50	5.80	6.00	92
	Back	1.60	1.80	1.90	2.00	30.5
	Seat	2.10	2.40	2.50	2.60	38.2
	Arm	1.90	2.20	2.30	2.40	36
K82LH12LTT	Entire Unit	3.90	4.50	4.70	4.90	75.5
	Back	1.60	1.80	1.90	2.00	30.5
	Seat	2.10	2.40	2.50	2.60	38.2
	Arm	1.00	1.20	1.20	1.30	20
K82LH12LTT2RAT	Entire Unit	4.70	5.40	5.60	5.90	91.5
	Back	1.60	1.80	1.90	2.00	30.5
	Seat	2.10	2.40	2.50	2.60	38.2
	Arm	1.80	2.10	2.20	2.30	34
K82LH12LTT2RAU	Entire Unit	4.80	5.50	5.80	6.00	92
	Back	1.60	1.80	1.90	2.00	30.5
	Seat	2.10	2.40	2.50	2.60	38.2
	Arm	1.90	2.20	2.30	2.40	36

COM YARDAGE REQUIREMENTS

COM YARDAGE REQUIREMENTS (54" WIDTH – CUT UP THE ROLL)

MODEL	RAILROADED Contact customer service 800-634-9510 for ydg requirements	NON DIRECTIONAL OR SOLID	1"-4" REPEAT	5"-11" REPEAT	12"-18" REPEAT	COL SQUARE FEET
			4" VERTICAL X 4" HORIZONTAL	11" VERTICAL X 11" HORIZONTAL	18" VERTICAL X 18" HORIZONTAL	
K82LH12LTW	Entire Unit	3.90	4.50	4.70	4.90	75.5
	Back	1.60	1.80	1.90	2.00	30.5
	Seat	2.10	2.40	2.50	2.60	38.2
	Arm	1.00	1.20	1.20	1.30	20
K82LH12LTW2RAU	Entire Unit	4.80	5.50	5.80	6.00	92
	Back	1.60	1.80	1.90	2.00	30.5
	Seat	2.10	2.40	2.50	2.60	38.2
	Arm	1.90	2.20	2.30	2.40	36
K82LH12LTW2RAW	Entire Unit	4.70	5.40	5.60	5.90	91.5
	Back	1.60	1.80	1.90	2.00	30.5
	Seat	2.10	2.40	2.50	2.60	38.2
	Arm	1.80	2.10	2.20	2.30	34
K82LH12RAP	Entire Unit	3.90	4.50	4.70	4.90	75.5
	Back	1.60	1.80	1.90	2.00	30.5
	Seat	2.10	2.40	2.50	2.60	38.2
	Arm	1.00	1.20	1.20	1.30	20
K82LH12RAS	Entire Unit	3.90	4.50	4.70	4.90	75.5
	Back	1.60	1.80	1.90	2.00	30.5
	Seat	2.10	2.40	2.50	2.60	38.2
	Arm	1.00	1.20	1.20	1.30	20
K82LH12RAT	Entire Unit	3.90	4.50	4.70	4.90	75.5
	Back	1.60	1.80	1.90	2.00	30.5
	Seat	2.10	2.40	2.50	2.60	38.2
	Arm	1.00	1.20	1.20	1.30	20
K82LH12RAU	Entire Unit	3.90	4.50	4.70	4.90	75.5
	Back	1.60	1.80	1.90	2.00	30.5
	Seat	2.10	2.40	2.50	2.60	38.2
	Arm	1.00	1.20	1.20	1.30	20
K82LH12RAW	Entire Unit	3.90	4.50	4.70	4.90	75.5
	Back	1.60	1.80	1.90	2.00	30.5
	Seat	2.10	2.40	2.50	2.60	38.2
	Arm	1.00	1.20	1.20	1.30	20
K82LH12RTL	Entire Unit	3.90	4.50	4.70	4.90	75.5
	Back	1.60	1.80	1.90	2.00	30.5
	Seat	2.10	2.40	2.50	2.60	38.2
	Arm	1.00	1.20	1.20	1.30	20
K82LH12RTT	Entire Unit	3.90	4.50	4.70	4.90	75.5
	Back	1.60	1.80	1.90	2.00	30.5
	Seat	2.10	2.40	2.50	2.60	38.2
	Arm	1.00	1.20	1.20	1.30	20
K82LH12RTW	Entire Unit	3.90	4.50	4.70	4.90	75.5
	Back	1.60	1.80	1.90	2.00	30.5
	Seat	2.10	2.40	2.50	2.60	38.2
	Arm	1.00	1.20	1.20	1.30	20
K82LH18LAS	Entire Unit	3.90	4.50	4.70	4.90	75.5
	Back	1.60	1.80	1.90	2.00	30.5
	Seat	2.10	2.40	2.50	2.60	38.2
	Arm	1.00	1.20	1.20	1.30	20
K82LH18LAS8RAS	Entire Unit	4.70	5.40	5.60	5.90	91.5
	Back	1.60	1.80	1.90	2.00	30.5
	Seat	2.10	2.40	2.50	2.60	38.2
	Arm	1.80	2.10	2.20	2.30	36
K82LH18LASTRAS	Entire Unit	4.70	5.40	5.60	5.90	91.5
	Back	1.60	1.80	1.90	2.00	30.5
	Seat	2.10	2.40	2.50	2.60	38.2
	Arm	1.80	2.10	2.20	2.30	36
K82LH18LAT	Entire Unit	3.90	4.50	4.70	4.90	75.5
	Back	1.60	1.80	1.90	2.00	30.5
	Seat	2.10	2.40	2.50	2.60	38.2
	Arm	1.00	1.20	1.20	1.30	20

COM YARDAGE REQUIREMENTS

COM YARDAGE REQUIREMENTS (54" WIDTH – CUT UP THE ROLL)

MODEL	RAILROADED Contact customer service 800-634-9510 for ydg requirements	NON DIRECTIONAL OR SOLID	1"-4" REPEAT	5"-11" REPEAT	12"-18" REPEAT	COL SQUARE FEET
			4" VERTICAL X 4" HORIZONTAL	11" VERTICAL X 11" HORIZONTAL	18" VERTICAL X 18" HORIZONTAL	
K82LH18LAT8RAT	Entire Unit	4.70	5.40	5.60	5.90	91.5
	Back	1.60	1.80	1.90	2.00	30.5
	Seat	2.10	2.40	2.50	2.60	38.2
	Arm	1.80	2.10	2.20	2.30	36
K82LH18LAT8RTT	Entire Unit	4.70	5.40	5.60	5.90	91.5
	Back	1.60	1.80	1.90	2.00	30.5
	Seat	2.10	2.40	2.50	2.60	38.2
	Arm	1.80	2.10	2.20	2.30	36
K82LH18LATTRAT	Entire Unit	4.70	5.40	5.60	5.90	91.5
	Back	1.60	1.80	1.90	2.00	30.5
	Seat	2.10	2.40	2.50	2.60	38.2
	Arm	1.80	2.10	2.20	2.30	36
K82LH18LATRLLS	Entire Unit	3.90	4.50	4.70	4.90	75.5
	Back	1.60	1.80	1.90	2.00	30.5
	Seat	2.10	2.40	2.50	2.60	38.2
	Arm	1.00	1.20	1.20	1.30	20
K82LH18LAU	Entire Unit	3.90	4.50	4.70	4.90	75.5
	Back	1.60	1.80	1.90	2.00	30.5
	Seat	2.10	2.40	2.50	2.60	38.2
	Arm	1.00	1.20	1.20	1.30	20
K82LH18LAU8RAU	Entire Unit	4.80	5.50	5.80	6.00	94
	Back	1.60	1.80	1.90	2.00	30.5
	Seat	2.10	2.40	2.50	2.60	38.2
	Arm	1.90	2.20	2.30	2.40	36
K82LH18LAU8RTL	Entire Unit	4.80	5.50	5.80	6.00	94
	Back	1.60	1.80	1.90	2.00	30.5
	Seat	2.10	2.40	2.50	2.60	38.2
	Arm	1.90	2.20	2.30	2.40	36
K82LH18LAU8RTT	Entire Unit	4.80	5.50	5.80	6.00	94
	Back	1.60	1.80	1.90	2.00	30.5
	Seat	2.10	2.40	2.50	2.60	38.2
	Arm	1.90	2.20	2.30	2.40	36
K82LH18LAU8RTW	Entire Unit	4.80	5.50	5.80	6.00	94
	Back	1.60	1.80	1.90	2.00	30.5
	Seat	2.10	2.40	2.50	2.60	38.2
	Arm	1.90	2.20	2.30	2.40	36
K82LH18LAW	Entire Unit	3.90	4.50	4.70	4.90	75.5
	Back	1.60	1.80	1.90	2.00	30.5
	Seat	2.10	2.40	2.50	2.60	38.2
	Arm	1.00	1.20	1.20	1.30	20
K82LH18LAW8RAW	Entire Unit	4.70	5.40	5.60	5.90	91.5
	Back	1.60	1.80	1.90	2.00	30.5
	Seat	2.10	2.40	2.50	2.60	38.2
	Arm	1.80	2.10	2.20	2.30	36
K82LH18LAW8RTW	Entire Unit	4.70	5.40	5.60	5.90	91.5
	Back	1.60	1.80	1.90	2.00	30.5
	Seat	2.10	2.40	2.50	2.60	38.2
	Arm	1.80	2.10	2.20	2.30	36
K82LH18LAWTRAW	Entire Unit	4.70	5.40	5.60	5.90	91.5
	Back	1.60	1.80	1.90	2.00	30.5
	Seat	2.10	2.40	2.50	2.60	38.2
	Arm	1.80	2.10	2.20	2.30	36
K82LH18LAWTRWS	Entire Unit	3.90	4.50	4.70	4.90	75.5
	Back	1.60	1.80	1.90	2.00	30.5
	Seat	2.10	2.40	2.50	2.60	38.2
	Arm	1.00	1.20	1.20	1.30	20
K82LH18LTL	Entire Unit	3.90	4.50	4.70	4.90	75.5
	Back	1.60	1.80	1.90	2.00	30.5
	Seat	2.10	2.40	2.50	2.60	38.2
	Arm	1.00	1.20	1.20	1.30	20

COM YARDAGE REQUIREMENTS

COM YARDAGE REQUIREMENTS (54" WIDTH – CUT UP THE ROLL)

MODEL	RAILROADED Contact customer service 800-634-9510 for ydg requirements	NON DIRECTIONAL OR SOLID	1"-4" REPEAT	5"-11" REPEAT	12"-18" REPEAT	COL SQUARE FEET
			4" VERTICAL X 4" HORIZONTAL	11" VERTICAL X 11" HORIZONTAL	18" VERTICAL X 18" HORIZONTAL	
K82LH18LT8RAU	Entire Unit	4.80	5.50	5.80	6.00	94
	Back	1.60	1.80	1.90	2.00	30.5
	Seat	2.10	2.40	2.50	2.60	38.2
	Arm	1.90	2.20	2.30	2.40	36
K82LH18LTLLS	Entire Unit	3.00	3.50	3.60	3.80	57
	Back	1.60	1.80	1.90	2.00	30.5
	Seat	2.10	2.40	2.50	2.60	38.2
K82LH18LTLWS	Entire Unit	3.00	3.50	3.60	3.80	57
	Back	1.60	1.80	1.90	2.00	30.5
	Seat	2.10	2.40	2.50	2.60	38.2
K82LH18LTT	Entire Unit	3.90	4.50	4.70	4.90	75.5
	Back	1.60	1.80	1.90	2.00	30.5
	Seat	2.10	2.40	2.50	2.60	38.2
	Arm	1.00	1.20	1.20	1.30	20
K82LH18LTT8RAT	Entire Unit	4.70	5.40	5.60	5.90	91.5
	Back	1.60	1.80	1.90	2.00	30.5
	Seat	2.10	2.40	2.50	2.60	38.2
	Arm	1.80	2.10	2.20	2.30	36
K82LH18LTT8RAU	Entire Unit	4.80	5.50	5.80	6.00	94
	Back	1.60	1.80	1.90	2.00	30.5
	Seat	2.10	2.40	2.50	2.60	38.2
	Arm	1.90	2.20	2.30	2.40	36
K82LH18TLLS	Entire Unit	3.00	3.50	3.60	3.80	57
	Back	1.60	1.80	1.90	2.00	30.5
	Seat	2.10	2.40	2.50	2.60	38.2
K82LH18LTTWS	Entire Unit	3.00	3.50	3.60	3.80	57
	Back	1.60	1.80	1.90	2.00	30.5
	Seat	2.10	2.40	2.50	2.60	38.2
K82LH18LTW	Entire Unit	3.90	4.50	4.70	4.90	75.5
	Back	1.60	1.80	1.90	2.00	30.5
	Seat	2.10	2.40	2.50	2.60	38.2
	Arm	1.00	1.20	1.20	1.30	20
K82LH18LTW8RAU	Entire Unit	4.80	5.50	5.80	6.00	94
	Back	1.60	1.80	1.90	2.00	30.5
	Seat	2.10	2.40	2.50	2.60	38.2
	Arm	1.90	2.20	2.30	2.40	36
K82LH18LTW8RAW	Entire Unit	4.70	5.40	5.60	5.90	91.5
	Back	1.60	1.80	1.90	2.00	30.5
	Seat	2.10	2.40	2.50	2.60	38.2
	Arm	1.80	2.10	2.20	2.30	36
K82LH18LTWLLS	Entire Unit	3.00	3.50	3.60	3.80	57
	Back	1.60	1.80	1.90	2.00	30.5
	Seat	2.10	2.40	2.50	2.60	38.2
K82LH18LTWWS	Entire Unit	3.00	3.50	3.60	3.80	57
	Back	1.60	1.80	1.90	2.00	30.5
	Seat	2.10	2.40	2.50	2.60	38.2
K82LH18RAS	Entire Unit	3.90	4.50	4.70	4.90	75.5
	Back	1.60	1.80	1.90	2.00	30.5
	Seat	2.10	2.40	2.50	2.60	38.2
	Arm	1.00	1.20	1.20	1.30	20
K82LH18RAT	Entire Unit	3.90	4.50	4.70	4.90	75.5
	Back	1.60	1.80	1.90	2.00	30.5
	Seat	2.10	2.40	2.50	2.60	38.2
	Arm	1.00	1.20	1.20	1.30	20
K82LH18RAU	Entire Unit	3.90	4.50	4.70	4.90	75.5
	Back	1.60	1.80	1.90	2.00	30.5
	Seat	2.10	2.40	2.50	2.60	38.2
	Arm	1.00	1.20	1.20	1.30	20

COM YARDAGE REQUIREMENTS

COM YARDAGE REQUIREMENTS (54" WIDTH – CUT UP THE ROLL)

MODEL	RAILROADED Contact customer service 800-634-9510 for ydg requirements	NON DIRECTIONAL OR SOLID	1"-4" REPEAT	5"-11" REPEAT	12"-18" REPEAT	COL SQUARE FEET
			4" VERTICAL X 4" HORIZONTAL	11" VERTICAL X 11" HORIZONTAL	18" VERTICAL X 18" HORIZONTAL	
K82LH18RAW	Entire Unit	3.90	4.50	4.70	4.90	75.5
	Back	1.60	1.80	1.90	2.00	30.5
	Seat	2.10	2.40	2.50	2.60	38.2
	Arm	1.00	1.20	1.20	1.30	20
K82LH18RTL	Entire Unit	3.90	4.50	4.70	4.90	75.5
	Back	1.60	1.80	1.90	2.00	30.5
	Seat	2.10	2.40	2.50	2.60	38.2
	Arm	1.00	1.20	1.20	1.30	20
K82LH18RTLCLS	Entire Unit	3.00	3.50	3.60	3.80	57
	Back	1.60	1.80	1.90	2.00	30.5
	Seat	2.10	2.40	2.50	2.60	38.2
K82LH18RTLWS	Entire Unit	3.00	3.50	3.60	3.80	57
	Back	1.60	1.80	1.90	2.00	30.5
	Seat	2.10	2.40	2.50	2.60	38.2
K82LH18RTT	Entire Unit	3.90	4.50	4.70	4.90	75.5
	Back	1.60	1.80	1.90	2.00	30.5
	Seat	2.10	2.40	2.50	2.60	38.2
	Arm	1.00	1.20	1.20	1.30	20
K82LH18RTCLS	Entire Unit	3.00	3.50	3.60	3.80	57
	Back	1.60	1.80	1.90	2.00	30.5
	Seat	2.10	2.40	2.50	2.60	38.2
K82LH18RTTWS	Entire Unit	3.00	3.50	3.60	3.80	57
	Back	1.60	1.80	1.90	2.00	30.5
	Seat	2.10	2.40	2.50	2.60	38.2
K82LH18RTW	Entire Unit	3.90	4.50	4.70	4.90	75.5
	Back	1.60	1.80	1.90	2.00	30.5
	Seat	2.10	2.40	2.50	2.60	38.2
	Arm	1.00	1.20	1.20	1.30	20
K82LH18RTWCLS	Entire Unit	3.00	3.50	3.60	3.80	57
	Back	1.60	1.80	1.90	2.00	30.5
	Seat	2.10	2.40	2.50	2.60	38.2
K82LH18RTWWS	Entire Unit	3.00	3.50	3.60	3.80	57
	Back	1.60	1.80	1.90	2.00	30.5
	Seat	2.10	2.40	2.50	2.60	38.2
K82LH1TLAS	Entire Unit	3.90	4.50	4.70	4.90	75.5
	Back	1.60	1.80	1.90	2.00	30.5
	Seat	2.10	2.40	2.50	2.60	38.2
	Arm	1.00	1.20	1.20	1.30	20
K82LH1TLAS2RAS	Entire Unit	4.80	5.50	5.80	6.00	94
	Back	1.60	1.80	1.90	2.00	30.5
	Seat	2.10	2.40	2.50	2.60	38.2
	Arm	1.90	2.20	2.30	2.40	38
K82LH1TLAS8RAS	Entire Unit	4.70	5.40	5.60	5.90	91.5
	Back	1.60	1.80	1.90	2.00	30.5
	Seat	2.10	2.40	2.50	2.60	38.2
	Arm	1.80	2.10	2.20	2.30	36
K82LH1TLAT	Entire Unit	3.90	4.50	4.70	4.90	75.5
	Back	1.60	1.80	1.90	2.00	30.5
	Seat	2.10	2.40	2.50	2.60	38.2
	Arm	1.00	1.20	1.20	1.30	20
K82LH1TLAT2RAT	Entire Unit	4.80	5.50	5.80	6.00	94
	Back	1.60	1.80	1.90	2.00	30.5
	Seat	2.10	2.40	2.50	2.60	38.2
	Arm	1.90	2.20	2.30	2.40	38
K82LH1TLAT8RAT	Entire Unit	4.70	5.40	5.60	5.90	91.5
	Back	1.60	1.80	1.90	2.00	30.5
	Seat	2.10	2.40	2.50	2.60	38.2
	Arm	1.80	2.10	2.20	2.30	36

COM YARDAGE REQUIREMENTS

COM YARDAGE REQUIREMENTS (54" WIDTH – CUT UP THE ROLL)

MODEL	RAILROADED Contact customer service 800-634-9510 for ydg requirements	NON DIRECTIONAL OR SOLID	1"-4" REPEAT	5"-11" REPEAT	12"-18" REPEAT	COL SQUARE FEET
			4" VERTICAL X 4" HORIZONTAL	11" VERTICAL X 11" HORIZONTAL	18" VERTICAL X 18" HORIZONTAL	
K82LH1TLAW	Entire Unit	3.90	4.50	4.70	4.90	75.5
	Back	1.60	1.80	1.90	2.00	30.5
	Seat	2.10	2.40	2.50	2.60	38.2
	Arm	1.00	1.20	1.20	1.30	20
K82LH1TLAW2RAW	Entire Unit	4.80	5.50	5.80	6.00	94
	Back	1.60	1.80	1.90	2.00	30.5
	Seat	2.10	2.40	2.50	2.60	38.2
	Arm	1.90	2.20	2.30	2.40	38
K82LH1TLAW8RAW	Entire Unit	4.70	5.40	5.60	5.90	91.5
	Back	1.60	1.80	1.90	2.00	30.5
	Seat	2.10	2.40	2.50	2.60	38.2
	Arm	1.80	2.10	2.20	2.30	36
K82LH1TLLLS2RAT	Entire Unit	3.90	4.50	4.70	4.90	75.5
	Back	1.60	1.80	1.90	2.00	30.5
	Seat	2.10	2.40	2.50	2.60	38.2
	Arm	1.00	1.20	1.20	1.30	20
K82LH1TLLLS8RAT	Entire Unit	3.90	4.50	4.70	4.90	75.5
	Back	1.60	1.80	1.90	2.00	30.5
	Seat	2.10	2.40	2.50	2.60	38.2
	Arm	1.00	1.20	1.20	1.30	20
K82LH1TLWS2RAW	Entire Unit	3.90	4.50	4.70	4.90	75.5
	Back	1.60	1.80	1.90	2.00	30.5
	Seat	2.10	2.40	2.50	2.60	38.2
	Arm	1.00	1.20	1.20	1.30	20
K82LH1TLWS8RAW	Entire Unit	3.90	4.50	4.70	4.90	75.5
	Back	1.60	1.80	1.90	2.00	30.5
	Seat	2.10	2.40	2.50	2.60	38.2
	Arm	1.00	1.20	1.20	1.30	20
K82LH1TRAS	Entire Unit	3.90	4.50	4.70	4.90	75.5
	Back	1.60	1.80	1.90	2.00	30.5
	Seat	2.10	2.40	2.50	2.60	38.2
	Arm	1.00	1.20	1.20	1.30	20
K82LH1TRAT	Entire Unit	3.90	4.50	4.70	4.90	75.5
	Back	1.60	1.80	1.90	2.00	30.5
	Seat	2.10	2.40	2.50	2.60	38.2
	Arm	1.00	1.20	1.20	1.30	20
K82LH1TRAW	Entire Unit	3.90	4.50	4.70	4.90	75.5
	Back	1.60	1.80	1.90	2.00	30.5
	Seat	2.10	2.40	2.50	2.60	38.2
	Arm	1.00	1.20	1.20	1.30	20
K82LH2	Entire Unit	5.80	6.70	7.00	7.30	112.4
	Back	3.10	3.60	3.70	3.90	60.4
	Seat	2.80	3.20	3.40	3.50	53.2
K82LH22LAP	Entire Unit	6.70	7.70	8.00	8.40	130.9
	Back	3.10	3.60	3.70	3.90	60.4
	Seat	2.80	3.20	3.40	3.50	53.2
	Arm	1.00	1.20	1.20	1.30	20
K82LH22LAP2RAP	Entire Unit	7.50	8.60	9.00	9.40	145.9
	Back	3.10	3.60	3.70	3.90	60.4
	Seat	2.80	3.20	3.40	3.50	53.2
	Arm	1.80	2.10	2.20	2.30	34
K82LH22LAS	Entire Unit	6.70	7.70	8.00	8.40	130.9
	Back	3.10	3.60	3.70	3.90	60.4
	Seat	2.80	3.20	3.40	3.50	53.2
	Arm	1.00	1.20	1.20	1.30	20
K82LH22LAS2RAS	Entire Unit	7.50	8.60	9.00	9.40	145.9
	Back	3.10	3.60	3.70	3.90	60.4
	Seat	2.80	3.20	3.40	3.50	53.2
	Arm	1.80	2.10	2.20	2.30	34

COM YARDAGE REQUIREMENTS

COM YARDAGE REQUIREMENTS (54" WIDTH – CUT UP THE ROLL)

MODEL	RAILROADED Contact customer service 800-634-9510 for ydg requirements	NON DIRECTIONAL OR SOLID	1"-4" REPEAT	5"-11" REPEAT	12"-18" REPEAT	COL SQUARE FEET
			4" VERTICAL X 4" HORIZONTAL	11" VERTICAL X 11" HORIZONTAL	18" VERTICAL X 18" HORIZONTAL	
K82LH22LASTRAS	Entire Unit	7.50	8.60	9.00	9.40	145.9
	Back	3.10	3.60	3.70	3.90	60.4
	Seat	2.80	3.20	3.40	3.50	53.2
	Arm	1.90	2.20	2.30	2.40	38
K82LH22LAT	Entire Unit	6.70	7.70	8.00	8.40	130.9
	Back	3.10	3.60	3.70	3.90	60.4
	Seat	2.80	3.20	3.40	3.50	53.2
	Arm	1.00	1.20	1.20	1.30	20
K82LH22LAT2RAT	Entire Unit	7.50	8.60	9.00	9.40	145.9
	Back	3.10	3.60	3.70	3.90	60.4
	Seat	2.80	3.20	3.40	3.50	53.2
	Arm	1.80	2.10	2.20	2.30	34
K82LH22LAT2RTT	Entire Unit	7.50	8.60	9.00	9.40	145.9
	Back	3.10	3.60	3.70	3.90	60.4
	Seat	2.80	3.20	3.40	3.50	53.2
	Arm	1.80	2.10	2.20	2.30	34
K82LH22LATTRAT	Entire Unit	7.50	8.60	9.00	9.40	145.9
	Back	3.10	3.60	3.70	3.90	60.4
	Seat	2.80	3.20	3.40	3.50	53.2
	Arm	1.90	2.20	2.30	2.40	38
K82LH22LAU	Entire Unit	6.70	7.70	8.00	8.40	130.9
	Back	3.10	3.60	3.70	3.90	60.4
	Seat	2.80	3.20	3.40	3.50	53.2
	Arm	1.00	1.20	1.20	1.30	20
K82LH22LAU2RAU	Entire Unit	7.60	8.70	9.10	9.50	148.4
	Back	3.10	3.60	3.70	3.90	60.4
	Seat	2.80	3.20	3.40	3.50	53.2
	Arm	1.90	2.20	2.30	2.40	36
K82LH22LAU2RTL	Entire Unit	7.60	8.70	9.10	9.50	148.4
	Back	3.10	3.60	3.70	3.90	60.4
	Seat	2.80	3.20	3.40	3.50	53.2
	Arm	1.90	2.20	2.30	2.40	36
K82LH22LAU2RTT	Entire Unit	7.60	8.70	9.10	9.50	148.4
	Back	3.10	3.60	3.70	3.90	60.4
	Seat	2.80	3.20	3.40	3.50	53.2
	Arm	1.90	2.20	2.30	2.40	36
K82LH22LAU2RTW	Entire Unit	7.60	8.70	9.10	9.50	148.4
	Back	3.10	3.60	3.70	3.90	60.4
	Seat	2.80	3.20	3.40	3.50	53.2
	Arm	1.90	2.20	2.30	2.40	36
K82LH22LAW	Entire Unit	6.70	7.70	8.00	8.40	130.9
	Back	3.10	3.60	3.70	3.90	60.4
	Seat	2.80	3.20	3.40	3.50	53.2
	Arm	1.00	1.20	1.20	1.30	20
K82LH22LAW2RAW	Entire Unit	7.50	8.60	9.00	9.40	145.9
	Back	3.10	3.60	3.70	3.90	60.4
	Seat	2.80	3.20	3.40	3.50	53.2
	Arm	1.80	2.10	2.20	2.30	34
K82LH22LAW2RTW	Entire Unit	7.50	8.60	9.00	9.40	145.9
	Back	3.10	3.60	3.70	3.90	60.4
	Seat	2.80	3.20	3.40	3.50	53.2
	Arm	1.80	2.10	2.20	2.30	34
K82LH22LAWTRAW	Entire Unit	7.50	8.60	9.00	9.40	145.9
	Back	3.10	3.60	3.70	3.90	60.4
	Seat	2.80	3.20	3.40	3.50	53.2
	Arm	1.90	2.20	2.30	2.40	38
K82LH22LTL	Entire Unit	6.70	7.70	8.00	8.40	130.9
	Back	3.10	3.60	3.70	3.90	60.4
	Seat	2.80	3.20	3.40	3.50	53.2
	Arm	1.00	1.20	1.20	1.30	20

COM YARDAGE REQUIREMENTS

COM YARDAGE REQUIREMENTS (54" WIDTH – CUT UP THE ROLL)

MODEL	RAILROADED Contact customer service 800-634-9510 for ydg requirements	NON DIRECTIONAL OR SOLID	1"-4" REPEAT	5"-11" REPEAT	12"-18" REPEAT	COL SQUARE FEET
			4" VERTICAL X 4" HORIZONTAL	11" VERTICAL X 11" HORIZONTAL	18" VERTICAL X 18" HORIZONTAL	
K82LH22LTL2RAU	Entire Unit	6.70	7.70	8.00	8.40	130.9
	Back	3.10	3.60	3.70	3.90	60.4
	Seat	2.80	3.20	3.40	3.50	53.2
	Arm	1.00	1.20	1.20	1.30	20
K82LH22LTT	Entire Unit	6.70	7.70	8.00	8.40	130.9
	Back	3.10	3.60	3.70	3.90	60.4
	Seat	2.80	3.20	3.40	3.50	53.2
	Arm	1.00	1.20	1.20	1.30	20
K82LH22LTT2RAT	Entire Unit	7.50	8.60	9.00	9.40	145.9
	Back	3.10	3.60	3.70	3.90	60.4
	Seat	2.80	3.20	3.40	3.50	53.2
	Arm	1.80	2.10	2.20	2.30	34
K82LH22LTT2RAU	Entire Unit	7.60	8.70	9.10	9.50	148.4
	Back	3.10	3.60	3.70	3.90	60.4
	Seat	2.80	3.20	3.40	3.50	53.2
	Arm	1.90	2.20	2.30	2.40	36
K82LH22LTTW	Entire Unit	6.70	7.70	8.00	8.40	130.9
	Back	3.10	3.60	3.70	3.90	60.4
	Seat	2.80	3.20	3.40	3.50	53.2
	Arm	1.00	1.20	1.20	1.30	20
K82LH22LTTW2RAU	Entire Unit	7.60	8.70	9.10	9.50	148.4
	Back	3.10	3.60	3.70	3.90	60.4
	Seat	2.80	3.20	3.40	3.50	53.2
	Arm	1.90	2.20	2.30	2.40	36
K82LH22LTTW2RAW	Entire Unit	7.50	8.60	9.00	9.40	145.9
	Back	3.10	3.60	3.70	3.90	60.4
	Seat	2.80	3.20	3.40	3.50	53.2
	Arm	1.80	2.10	2.20	2.30	34
K82LH22RAP	Entire Unit	6.70	7.70	8.00	8.40	130.9
	Back	3.10	3.60	3.70	3.90	60.4
	Seat	2.80	3.20	3.40	3.50	53.2
	Arm	1.00	1.20	1.20	1.30	20
K82LH22RAS	Entire Unit	6.70	7.70	8.00	8.40	130.9
	Back	3.10	3.60	3.70	3.90	60.4
	Seat	2.80	3.20	3.40	3.50	53.2
	Arm	1.00	1.20	1.20	1.30	20
K82LH22RAT	Entire Unit	6.70	7.70	8.00	8.40	130.9
	Back	3.10	3.60	3.70	3.90	60.4
	Seat	2.80	3.20	3.40	3.50	53.2
	Arm	1.00	1.20	1.20	1.30	20
K82LH22RAU	Entire Unit	6.70	7.70	8.00	8.40	130.9
	Back	3.10	3.60	3.70	3.90	60.4
	Seat	2.80	3.20	3.40	3.50	53.2
	Arm	1.00	1.20	1.20	1.30	20
K82LH22RAW	Entire Unit	6.70	7.70	8.00	8.40	130.9
	Back	3.10	3.60	3.70	3.90	60.4
	Seat	2.80	3.20	3.40	3.50	53.2
	Arm	1.00	1.20	1.20	1.30	20
K82LH22RTL	Entire Unit	6.70	7.70	8.00	8.40	130.9
	Back	3.10	3.60	3.70	3.90	60.4
	Seat	2.80	3.20	3.40	3.50	53.2
	Arm	1.00	1.20	1.20	1.30	20
K82LH22RTT	Entire Unit	6.70	7.70	8.00	8.40	130.9
	Back	3.10	3.60	3.70	3.90	60.4
	Seat	2.80	3.20	3.40	3.50	53.2
	Arm	1.00	1.20	1.20	1.30	20
K82LH22RTW	Entire Unit	6.70	7.70	8.00	8.40	130.9
	Back	3.10	3.60	3.70	3.90	60.4
	Seat	2.80	3.20	3.40	3.50	53.2
	Arm	1.00	1.20	1.20	1.30	20

COM YARDAGE REQUIREMENTS

COM YARDAGE REQUIREMENTS (54" WIDTH – CUT UP THE ROLL)

MODEL	RAILROADED Contact customer service 800-634-9510 for ydg requirements	NON DIRECTIONAL OR SOLID	1"-4" REPEAT	5"-11" REPEAT	12"-18" REPEAT	COL SQUARE FEET
			4" VERTICAL X 4" HORIZONTAL	11" VERTICAL X 11" HORIZONTAL	18" VERTICAL X 18" HORIZONTAL	
K82LH28LAS	Entire Unit	6.70	7.70	8.00	8.40	130.9
	Back	3.10	3.60	3.70	3.90	60.4
	Seat	2.80	3.20	3.40	3.50	53.2
	Arm	1.00	1.20	1.20	1.30	20
K82LH28LAS8RAS	Entire Unit	7.50	8.60	9.00	9.40	145.9
	Back	3.10	3.60	3.70	3.90	60.4
	Seat	2.80	3.20	3.40	3.50	53.2
	Arm	1.80	2.10	2.20	2.30	36
K82LH28LASTRAS	Entire Unit	7.50	8.60	9.00	9.40	145.9
	Back	3.10	3.60	3.70	3.90	60.4
	Seat	2.80	3.20	3.40	3.50	53.2
	Arm	1.80	2.10	2.20	2.30	36
K82LH28LAT	Entire Unit	6.70	7.70	8.00	8.40	130.9
	Back	3.10	3.60	3.70	3.90	60.4
	Seat	2.80	3.20	3.40	3.50	53.2
	Arm	1.00	1.20	1.20	1.30	20
K82LH28LAT8RAT	Entire Unit	7.50	8.60	9.00	9.40	145.9
	Back	3.10	3.60	3.70	3.90	60.4
	Seat	2.80	3.20	3.40	3.50	53.2
	Arm	1.80	2.10	2.20	2.30	36
K82LH28LAT8RTT	Entire Unit	7.60	8.70	9.10	9.50	148.4
	Back	3.10	3.60	3.70	3.90	60.4
	Seat	2.80	3.20	3.40	3.50	53.2
	Arm	1.80	2.10	2.20	2.30	36
K82LH28LATTRAT	Entire Unit	7.50	8.60	9.00	9.40	145.9
	Back	3.10	3.60	3.70	3.90	60.4
	Seat	2.80	3.20	3.40	3.50	53.2
	Arm	1.80	2.10	2.20	2.30	36
K82LH28LAU	Entire Unit	6.70	7.70	8.00	8.40	130.9
	Back	3.10	3.60	3.70	3.90	60.4
	Seat	2.80	3.20	3.40	3.50	53.2
	Arm	1.00	1.20	1.20	1.30	20
K82LH28LAU8RAU	Entire Unit	7.60	8.70	9.10	9.50	148.4
	Back	3.10	3.60	3.70	3.90	60.4
	Seat	2.80	3.20	3.40	3.50	53.2
	Arm	1.90	2.20	2.30	2.40	36
K82LH28LAU8RTL	Entire Unit	7.60	8.70	9.10	9.50	148.4
	Back	3.10	3.60	3.70	3.90	60.4
	Seat	2.80	3.20	3.40	3.50	53.2
	Arm	1.90	2.20	2.30	2.40	36
K82LH28LAU8RTT	Entire Unit	7.60	8.70	9.10	9.50	148.4
	Back	3.10	3.60	3.70	3.90	60.4
	Seat	2.80	3.20	3.40	3.50	53.2
	Arm	1.90	2.20	2.30	2.40	36
K82LH28LAU8RTW	Entire Unit	7.60	8.70	9.10	9.50	148.4
	Back	3.10	3.60	3.70	3.90	60.4
	Seat	2.80	3.20	3.40	3.50	53.2
	Arm	1.90	2.20	2.30	2.40	36
K82LH28LAW	Entire Unit	6.70	7.70	8.00	8.40	130.9
	Back	3.10	3.60	3.70	3.90	60.4
	Seat	2.80	3.20	3.40	3.50	53.2
	Arm	1.00	1.20	1.20	1.30	20
K82LH28LAW8RAW	Entire Unit	7.50	8.60	9.00	9.40	145.9
	Back	3.10	3.60	3.70	3.90	60.4
	Seat	2.80	3.20	3.40	3.50	53.2
	Arm	1.80	2.10	2.20	2.30	36
K82LH28LAW8RTW	Entire Unit	7.60	8.70	9.10	9.50	148.4
	Back	3.10	3.60	3.70	3.90	60.4
	Seat	2.80	3.20	3.40	3.50	53.2
	Arm	1.80	2.10	2.20	2.30	36

COM YARDAGE REQUIREMENTS

COM YARDAGE REQUIREMENTS (54" WIDTH – CUT UP THE ROLL)

MODEL	RAILROADED Contact customer service 800-634-9510 for ydg requirements	NON DIRECTIONAL OR SOLID	1"-4" REPEAT	5"-11" REPEAT	12"-18" REPEAT	COL SQUARE FEET
			4" VERTICAL X 4" HORIZONTAL	11" VERTICAL X 11" HORIZONTAL	18" VERTICAL X 18" HORIZONTAL	
K82LH28LAWTRAW	Entire Unit	7.50	8.60	9.00	9.40	145.9
	Back	3.10	3.60	3.70	3.90	60.4
	Seat	2.80	3.20	3.40	3.50	53.2
	Arm	1.80	2.10	2.20	2.30	36
K82LH28LTL	Entire Unit	6.70	7.70	8.00	8.40	130.9
	Back	3.10	3.60	3.70	3.90	60.4
	Seat	2.80	3.20	3.40	3.50	53.2
	Arm	1.00	1.20	1.20	1.30	20
K82LH28LTL8RAU	Entire Unit	7.60	8.70	9.10	9.50	148.4
	Back	3.10	3.60	3.70	3.90	60.4
	Seat	2.80	3.20	3.40	3.50	53.2
	Arm	1.90	2.20	2.30	2.40	36
K82LH28LTL8RTL	Entire Unit	7.60	8.70	9.10	9.50	148.4
	Back	3.10	3.60	3.70	3.90	60.4
	Seat	2.80	3.20	3.40	3.50	53.2
	Arm	1.90	2.20	2.30	2.40	36
K82LH28LTT	Entire Unit	6.70	7.70	8.00	8.40	130.9
	Back	3.10	3.60	3.70	3.90	60.4
	Seat	2.80	3.20	3.40	3.50	53.2
	Arm	1.00	1.20	1.20	1.30	20
K82LH28LTT8RAT	Entire Unit	7.60	8.70	9.10	9.50	148.4
	Back	3.10	3.60	3.70	3.90	60.4
	Seat	2.80	3.20	3.40	3.50	53.2
	Arm	1.80	2.10	2.20	2.30	36
K82LH28LTT8RAU	Entire Unit	7.60	8.70	9.10	9.50	148.4
	Back	3.10	3.60	3.70	3.90	60.4
	Seat	2.80	3.20	3.40	3.50	53.2
	Arm	1.90	2.20	2.30	2.40	36
K82LH28LTT8RTT	Entire Unit	7.60	8.70	9.10	9.50	148.4
	Back	3.10	3.60	3.70	3.90	60.4
	Seat	2.80	3.20	3.40	3.50	53.2
	Arm	1.90	2.20	2.30	2.40	36
K82LH28LTTW	Entire Unit	6.70	7.70	8.00	8.40	130.9
	Back	3.10	3.60	3.70	3.90	60.4
	Seat	2.80	3.20	3.40	3.50	53.2
	Arm	1.00	1.20	1.20	1.30	20
K82LH28LTTW8RAU	Entire Unit	7.60	8.70	9.10	9.50	148.4
	Back	3.10	3.60	3.70	3.90	60.4
	Seat	2.80	3.20	3.40	3.50	53.2
	Arm	1.90	2.20	2.30	2.40	36
K82LH28LTTW8RAW	Entire Unit	7.60	8.70	9.10	9.50	148.4
	Back	3.10	3.60	3.70	3.90	60.4
	Seat	2.80	3.20	3.40	3.50	53.2
	Arm	1.80	2.10	2.20	2.30	36
K82LH28LTTW8RTW	Entire Unit	7.60	8.70	9.10	9.50	148.4
	Back	3.10	3.60	3.70	3.90	60.4
	Seat	2.80	3.20	3.40	3.50	53.2
	Arm	1.90	2.20	2.30	2.40	36
K82LH28RAS	Entire Unit	6.70	7.70	8.00	8.40	130.9
	Back	3.10	3.60	3.70	3.90	60.4
	Seat	2.80	3.20	3.40	3.50	53.2
	Arm	1.00	1.20	1.20	1.30	20
K82LH28RAT	Entire Unit	6.70	7.70	8.00	8.40	130.9
	Back	3.10	3.60	3.70	3.90	60.4
	Seat	2.80	3.20	3.40	3.50	53.2
	Arm	1.00	1.20	1.20	1.30	20
K82LH28RAU	Entire Unit	6.70	7.70	8.00	8.40	130.9
	Back	3.10	3.60	3.70	3.90	60.4
	Seat	2.80	3.20	3.40	3.50	53.2
	Arm	1.00	1.20	1.20	1.30	20

COM YARDAGE REQUIREMENTS

COM YARDAGE REQUIREMENTS (54" WIDTH – CUT UP THE ROLL)

MODEL	RAILROADED Contact customer service 800-634-9510 for ydg requirements	NON DIRECTIONAL OR SOLID	1"-4" REPEAT	5"-11" REPEAT	12"-18" REPEAT	COL SQUARE FEET
			4" VERTICAL X 4" HORIZONTAL	11" VERTICAL X 11" HORIZONTAL	18" VERTICAL X 18" HORIZONTAL	
K82LH28RAW	Entire Unit	6.70	7.70	8.00	8.40	130.9
	Back	3.10	3.60	3.70	3.90	60.4
	Seat	2.80	3.20	3.40	3.50	53.2
	Arm	1.00	1.20	1.20	1.30	20
K82LH28RTL	Entire Unit	6.70	7.70	8.00	8.40	130.9
	Back	3.10	3.60	3.70	3.90	60.4
	Seat	2.80	3.20	3.40	3.50	53.2
	Arm	1.00	1.20	1.20	1.30	20
K82LH28RTT	Entire Unit	6.70	7.70	8.00	8.40	130.9
	Back	3.10	3.60	3.70	3.90	60.4
	Seat	2.80	3.20	3.40	3.50	53.2
	Arm	1.00	1.20	1.20	1.30	20
K82LH28RTW	Entire Unit	6.70	7.70	8.00	8.40	130.9
	Back	3.10	3.60	3.70	3.90	60.4
	Seat	2.80	3.20	3.40	3.50	53.2
	Arm	1.00	1.20	1.20	1.30	20
K82LH2TLAS	Entire Unit	6.70	7.70	8.00	8.40	130.9
	Back	3.10	3.60	3.70	3.90	60.4
	Seat	2.80	3.20	3.40	3.50	53.2
	Arm	1.00	1.20	1.20	1.30	20
K82LH2TLAS2RAS	Entire Unit	7.50	8.60	9.00	9.40	145.9
	Back	3.10	3.60	3.70	3.90	60.4
	Seat	2.80	3.20	3.40	3.50	53.2
	Arm	1.90	2.20	2.30	2.40	38
K82LH2TLAS8RAS	Entire Unit	7.50	8.60	9.00	9.40	145.9
	Back	3.10	3.60	3.70	3.90	60.4
	Seat	2.80	3.20	3.40	3.50	53.2
	Arm	1.80	2.10	2.20	2.30	36
K82LH2TLAS8RAS	Entire Unit	7.50	8.60	9.00	9.40	145.9
	Back	3.10	3.60	3.70	3.90	60.4
	Seat	2.80	3.20	3.40	3.50	53.2
	Arm	1.80	2.10	2.20	2.30	36
K82LH2TLASTRAS	Entire Unit	7.60	8.70	9.10	9.50	148.4
	Back	3.10	3.60	3.70	3.90	60.4
	Seat	2.80	3.20	3.40	3.50	53.2
	Arm	1.90	2.20	2.30	2.40	36
K82LH2TLAT	Entire Unit	6.70	7.70	8.00	8.40	130.9
	Back	3.10	3.60	3.70	3.90	60.4
	Seat	2.80	3.20	3.40	3.50	53.2
	Arm	1.00	1.20	1.20	1.30	20
K82LH2TLAT2RAT	Entire Unit	7.50	8.60	9.00	9.40	145.9
	Back	3.10	3.60	3.70	3.90	60.4
	Seat	2.80	3.20	3.40	3.50	53.2
	Arm	1.90	2.20	2.30	2.40	38
K82LH2TLAT8RAT	Entire Unit	7.50	8.60	9.00	9.40	145.9
	Back	3.10	3.60	3.70	3.90	60.4
	Seat	2.80	3.20	3.40	3.50	53.2
	Arm	1.90	2.20	2.30	2.40	38
K82LH2TLATTRAT	Entire Unit	7.60	8.70	9.10	9.50	148.4
	Back	3.10	3.60	3.70	3.90	60.4
	Seat	2.80	3.20	3.40	3.50	53.2
	Arm	1.90	2.20	2.30	2.40	36
K82LH2TLAW	Entire Unit	6.70	7.70	8.00	8.40	130.9
	Back	3.10	3.60	3.70	3.90	60.4
	Seat	2.80	3.20	3.40	3.50	53.2
	Arm	1.00	1.20	1.20	1.30	20
K82LH2TLAW2RAW	Entire Unit	7.50	8.60	9.00	9.40	145.9
	Back	3.10	3.60	3.70	3.90	60.4
	Seat	2.80	3.20	3.40	3.50	53.2
	Arm	1.90	2.20	2.30	2.40	38
K82LH2TLAW8RAW	Entire Unit	7.50	8.60	9.00	9.40	145.9
	Back	3.10	3.60	3.70	3.90	60.4
	Seat	2.80	3.20	3.40	3.50	53.2
	Arm	1.80	2.10	2.20	2.30	36

COM YARDAGE REQUIREMENTS

COM YARDAGE REQUIREMENTS (54" WIDTH – CUT UP THE ROLL)

MODEL	RAILROADED Contact customer service 800-634-9510 for ydg requirements	NON DIRECTIONAL OR SOLID	1"-4" REPEAT	5"-11" REPEAT	12"-18" REPEAT	COL SQUARE FEET
			4" VERTICAL X 4" HORIZONTAL	11" VERTICAL X 11" HORIZONTAL	18" VERTICAL X 18" HORIZONTAL	
K82LH2TLAWTRAW	Entire Unit	7.60	8.70	9.10	9.50	148.4
	Back	3.10	3.60	3.70	3.90	60.4
	Seat	2.80	3.20	3.40	3.50	53.2
	Arm	1.90	2.20	2.30	2.40	36
K82LH2TRAS	Entire Unit	6.70	7.70	8.00	8.40	130.9
	Back	3.10	3.60	3.70	3.90	60.4
	Seat	2.80	3.20	3.40	3.50	53.2
	Arm	1.00	1.20	1.20	1.30	20
K82LH2TRAT	Entire Unit	6.70	7.70	8.00	8.40	130.9
	Back	3.10	3.60	3.70	3.90	60.4
	Seat	2.80	3.20	3.40	3.50	53.2
	Arm	1.00	1.20	1.20	1.30	20
K82LH2TRAW	Entire Unit	6.70	7.70	8.00	8.40	130.9
	Back	3.10	3.60	3.70	3.90	60.4
	Seat	2.80	3.20	3.40	3.50	53.2
	Arm	1.00	1.20	1.20	1.30	20
K82LH3	Entire Unit	8.70	10.00	10.40	10.90	168.3
	Back	4.50	5.20	5.40	5.60	89.7
	Seat	4.20	4.80	5.00	5.30	79.2
K82LH32LAP	Entire Unit	9.60	11.00	11.50	12.00	186.8
	Back	4.50	5.20	5.40	5.60	89.7
	Seat	4.20	4.80	5.00	5.30	79.2
	Arm	1.00	1.20	1.20	1.30	20
K82LH32LAP2RAP	Entire Unit	10.50	12.10	12.60	13.10	204.3
	Back	4.50	5.20	5.40	5.60	89.7
	Seat	4.20	4.80	5.00	5.30	79.2
	Arm	1.80	2.10	2.20	2.30	34
K82LH32LAS	Entire Unit	9.60	11.00	11.50	12.00	186.8
	Back	4.50	5.20	5.40	5.60	89.7
	Seat	4.20	4.80	5.00	5.30	79.2
	Arm	1.00	1.20	1.20	1.30	20
K82LH32LAS2RAS	Entire Unit	10.50	12.10	12.60	13.10	204.3
	Back	4.50	5.20	5.40	5.60	89.7
	Seat	4.20	4.80	5.00	5.30	79.2
	Arm	1.80	2.10	2.20	2.30	34
K82LH32LASTRAS	Entire Unit	10.40	12.00	12.50	13.00	202.3
	Back	4.50	5.20	5.40	5.60	89.7
	Seat	4.20	4.80	5.00	5.30	79.2
	Arm	1.90	2.20	2.30	2.40	38
K82LH32LAT	Entire Unit	9.60	11.00	11.50	12.00	186.8
	Back	4.50	5.20	5.40	5.60	89.7
	Seat	4.20	4.80	5.00	5.30	79.2
	Arm	1.00	1.20	1.20	1.30	20
K82LH32LAT2RAT	Entire Unit	10.50	12.10	12.60	13.10	204.3
	Back	4.50	5.20	5.40	5.60	89.7
	Seat	4.20	4.80	5.00	5.30	79.2
	Arm	1.80	2.10	2.20	2.30	34
K82LH32LAT2RTT	Entire Unit	10.40	12.00	12.50	13.00	202.3
	Back	4.50	5.20	5.40	5.60	89.7
	Seat	4.20	4.80	5.00	5.30	79.2
	Arm	1.80	2.10	2.20	2.30	34
K82LH32LATTRAT	Entire Unit	10.40	12.00	12.50	13.00	202.3
	Back	4.50	5.20	5.40	5.60	89.7
	Seat	4.20	4.80	5.00	5.30	79.2
	Arm	1.90	2.20	2.30	2.40	38
K82LH32LAU	Entire Unit	9.60	11.00	11.50	12.00	186.8
	Back	4.50	5.20	5.40	5.60	89.7
	Seat	4.20	4.80	5.00	5.30	79.2
	Arm	1.00	1.20	1.20	1.30	20

COM YARDAGE REQUIREMENTS

COM YARDAGE REQUIREMENTS (54" WIDTH – CUT UP THE ROLL)

MODEL	RAILROADED Contact customer service 800-634-9510 for ydg requirements	NON DIRECTIONAL OR SOLID	1"-4" REPEAT	5"-11" REPEAT	12"-18" REPEAT	COL SQUARE FEET
			4" VERTICAL X 4" HORIZONTAL	11" VERTICAL X 11" HORIZONTAL	18" VERTICAL X 18" HORIZONTAL	
K82LH32LAU2RAU	Entire Unit	10.50	12.10	12.60	13.10	204.3
	Back	4.50	5.20	5.40	5.60	89.7
	Seat	4.00	4.60	4.80	5.00	79.2
	Arm	1.90	2.20	2.30	2.40	36
K82LH32LAU2RTL	Entire Unit	10.30	11.80	12.40	12.90	204.3
	Back	4.50	5.20	5.40	5.60	89.7
	Seat	4.00	4.60	4.80	5.00	79.2
	Arm	1.90	2.20	2.30	2.40	36
K82LH32LAU2RTT	Entire Unit	10.30	11.80	12.40	12.90	204.3
	Back	4.50	5.20	5.40	5.60	89.7
	Seat	4.00	4.60	4.80	5.00	79.2
	Arm	1.90	2.20	2.30	2.40	36
K82LH32LAU2RTW	Entire Unit	10.50	12.10	12.60	13.10	204.3
	Back	4.50	5.20	5.40	5.60	89.7
	Seat	4.20	4.80	5.00	5.30	79.2
	Arm	1.90	2.20	2.30	2.40	36
K82LH32LAW	Entire Unit	5.20	6.00	6.20	6.50	98.8
	Back	4.50	5.20	5.40	5.60	89.7
	Seat	4.20	4.80	5.00	5.30	79.2
	Arm	1.80	2.10	2.20	2.30	34
K82LH32LAW2RAW	Entire Unit	10.50	12.10	12.60	13.10	204.3
	Back	4.50	5.20	5.40	5.60	89.7
	Seat	4.20	4.80	5.00	5.30	79.2
	Arm	1.80	2.10	2.20	2.30	34
K82LH32LAW2RTW	Entire Unit	10.40	12.00	12.50	13.00	202.3
	Back	4.50	5.20	5.40	5.60	89.7
	Seat	4.20	4.80	5.00	5.30	79.2
	Arm	1.80	2.10	2.20	2.30	34
K82LH32LAWTRAW	Entire Unit	10.40	12.00	12.50	13.00	202.3
	Back	4.50	5.20	5.40	5.60	89.7
	Seat	4.20	4.80	5.00	5.30	79.2
	Arm	1.90	2.20	2.30	2.40	38
K82LH32LTL	Entire Unit	9.60	11.00	11.50	12.00	186.8
	Back	4.50	5.20	5.40	5.60	89.7
	Seat	4.20	4.80	5.00	5.30	79.2
	Arm	1.00	1.20	1.20	1.30	20
K82LH32LTL2RAU	Entire Unit	10.50	12.10	12.60	13.10	204.3
	Back	4.50	5.20	5.40	5.60	89.7
	Seat	4.20	4.80	5.00	5.30	79.2
	Arm	1.90	2.20	2.30	2.40	36
K82LH32LTT	Entire Unit	9.60	11.00	11.50	12.00	186.8
	Back	4.50	5.20	5.40	5.60	89.7
	Seat	4.20	4.80	5.00	5.30	79.2
	Arm	1.00	1.20	1.20	1.30	20
K82LH32LTT2RAT	Entire Unit	10.40	12.00	12.50	13.00	202.3
	Back	4.50	5.20	5.40	5.60	89.7
	Seat	4.20	4.80	5.00	5.30	79.2
	Arm	1.80	2.10	2.20	2.30	34
K82LH32LTT2RAU	Entire Unit	10.50	12.10	12.60	13.10	204.3
	Back	4.50	5.20	5.40	5.60	89.7
	Seat	4.20	4.80	5.00	5.30	79.2
	Arm	1.90	2.20	2.30	2.40	36
K82LH32LTTW	Entire Unit	9.60	11.00	11.50	12.00	186.8
	Back	4.50	5.20	5.40	5.60	89.7
	Seat	4.20	4.80	5.00	5.30	79.2
	Arm	1.00	1.20	1.20	1.30	20
K82LH32LTTW2RAU	Entire Unit	10.50	12.10	12.60	13.10	204.3
	Back	4.50	5.20	5.40	5.60	89.7
	Seat	4.20	4.80	5.00	5.30	79.2
	Arm	1.90	2.20	2.30	2.40	36

COM YARDAGE REQUIREMENTS

COM YARDAGE REQUIREMENTS (54" WIDTH – CUT UP THE ROLL)

MODEL	RAILROADED Contact customer service 800-634-9510 for ydg requirements	NON DIRECTIONAL OR SOLID	1"-4" REPEAT	5"-11" REPEAT	12"-18" REPEAT	COL SQUARE FEET
			4" VERTICAL X 4" HORIZONTAL	11" VERTICAL X 11" HORIZONTAL	18" VERTICAL X 18" HORIZONTAL	
K82LH32LTW2RAW	Entire Unit	10.40	12.00	12.50	13.00	202.3
	Back	4.50	5.20	5.40	5.60	89.7
	Seat	4.20	4.80	5.00	5.30	79.2
	Arm	1.80	2.10	2.20	2.30	34
K82LH32RAP	Entire Unit	9.60	11.00	11.50	12.00	186.8
	Back	4.50	5.20	5.40	5.60	89.7
	Seat	4.20	4.80	5.00	5.30	79.2
	Arm	1.00	1.20	1.20	1.30	20
K82LH32RAS	Entire Unit	9.60	11.00	11.50	12.00	186.8
	Back	4.50	5.20	5.40	5.60	89.7
	Seat	4.20	4.80	5.00	5.30	79.2
	Arm	1.00	1.20	1.20	1.30	20
K82LH32RAT	Entire Unit	9.60	11.00	11.50	12.00	186.8
	Back	4.50	5.20	5.40	5.60	89.7
	Seat	4.20	4.80	5.00	5.30	79.2
	Arm	1.00	1.20	1.20	1.30	20
K82LH32RAU	Entire Unit	9.60	11.00	11.50	12.00	186.8
	Back	4.50	5.20	5.40	5.60	89.7
	Seat	4.20	4.80	5.00	5.30	79.2
	Arm	1.00	1.20	1.20	1.30	20
K82LH32RAW	Entire Unit	9.60	11.00	11.50	12.00	186.8
	Back	4.50	5.20	5.40	5.60	89.7
	Seat	4.20	4.80	5.00	5.30	79.2
	Arm	1.00	1.20	1.20	1.30	20
K82LH32RTL	Entire Unit	9.60	11.00	11.50	12.00	186.8
	Back	4.50	5.20	5.40	5.60	89.7
	Seat	4.20	4.80	5.00	5.30	79.2
	Arm	1.00	1.20	1.20	1.30	20
K82LH32RTT	Entire Unit	9.60	11.00	11.50	12.00	186.8
	Back	4.50	5.20	5.40	5.60	89.7
	Seat	4.20	4.80	5.00	5.30	79.2
	Arm	1.00	1.20	1.20	1.30	20
K82LH32RTW	Entire Unit	9.60	11.00	11.50	12.00	186.8
	Back	4.50	5.20	5.40	5.60	89.7
	Seat	4.20	4.80	5.00	5.30	79.2
	Arm	1.00	1.20	1.20	1.30	20
K82LH38LAS	Entire Unit	9.60	11.00	11.50	12.00	186.8
	Back	4.50	5.20	5.40	5.60	89.7
	Seat	4.20	4.80	5.00	5.30	79.2
	Arm	1.00	1.20	1.20	1.30	20
K82LH38LAS8RAS	Entire Unit	10.40	12.00	12.50	13.00	202.3
	Back	4.50	5.20	5.40	5.60	89.7
	Seat	4.20	4.80	5.00	5.30	79.2
	Arm	1.80	2.10	2.20	2.30	36
K82LH38LASTRAS	Entire Unit	10.40	12.00	12.50	13.00	202.3
	Back	4.50	5.20	5.40	5.60	89.7
	Seat	4.20	4.80	5.00	5.30	79.2
	Arm	1.80	2.10	2.20	2.30	36
K82LH38LAT	Entire Unit	9.60	11.00	11.50	12.00	186.8
	Back	4.50	5.20	5.40	5.60	89.7
	Seat	4.20	4.80	5.00	5.30	79.2
	Arm	1.00	1.20	1.20	1.30	20
K82LH38LAT8RAT	Entire Unit	10.40	12.00	12.50	13.00	202.3
	Back	4.50	5.20	5.40	5.60	89.7
	Seat	4.20	4.80	5.00	5.30	79.2
	Arm	1.80	2.10	2.20	2.30	36
K82LH38LAT8RTT	Entire Unit	10.40	12.00	12.50	13.00	202.3
	Back	4.50	5.20	5.40	5.60	89.7
	Seat	4.20	4.80	5.00	5.30	79.2
	Arm	1.80	2.10	2.20	2.30	36

COM YARDAGE REQUIREMENTS

COM YARDAGE REQUIREMENTS (54" WIDTH – CUT UP THE ROLL)

MODEL	RAILROADED Contact customer service 800-634-9510 for ydg requirements	NON DIRECTIONAL OR SOLID	1"-4" REPEAT	5"-11" REPEAT	12"-18" REPEAT	COL SQUARE FEET
			4" VERTICAL X 4" HORIZONTAL	11" VERTICAL X 11" HORIZONTAL	18" VERTICAL X 18" HORIZONTAL	
K82LH38LATRAT	Entire Unit	10.40	12.00	12.50	13.00	202.3
	Back	4.50	5.20	5.40	5.60	89.7
	Seat	4.20	4.80	5.00	5.30	79.2
	Arm	1.80	2.10	2.20	2.30	36
K82LH38LAU	Entire Unit	9.60	11.00	11.50	12.00	186.8
	Back	4.50	5.20	5.40	5.60	89.7
	Seat	4.20	4.80	5.00	5.30	79.2
	Arm	1.00	1.20	1.20	1.30	20
K82LH38LAU8RAU	Entire Unit	10.50	12.10	12.60	13.10	204.3
	Back	4.50	5.20	5.40	5.60	89.7
	Seat	4.20	4.80	5.00	5.30	79.2
	Arm	1.90	2.20	2.30	2.40	36
K82LH38LAU8RTL	Entire Unit	10.50	12.10	12.60	13.10	204.3
	Back	4.50	5.20	5.40	5.60	89.7
	Seat	4.20	4.80	5.00	5.30	79.2
	Arm	1.90	2.20	2.30	2.40	36
K82LH38LAU8RTT	Entire Unit	10.50	12.10	12.60	13.10	204.3
	Back	4.50	5.20	5.40	5.60	89.7
	Seat	4.20	4.80	5.00	5.30	79.2
	Arm	1.90	2.20	2.30	2.40	36
K82LH38LAU8RTW	Entire Unit	10.50	12.10	12.60	13.10	204.3
	Back	4.50	5.20	5.40	5.60	89.7
	Seat	4.20	4.80	5.00	5.30	79.2
	Arm	1.90	2.20	2.30	2.40	36
K82LH38LAW	Entire Unit	9.60	11.00	11.50	12.00	186.8
	Back	4.50	5.20	5.40	5.60	89.7
	Seat	4.20	4.80	5.00	5.30	79.2
	Arm	1.00	1.20	1.20	1.30	20
K82LH38LAW8RAW	Entire Unit	10.40	12.00	12.50	13.00	202.3
	Back	4.50	5.20	5.40	5.60	89.7
	Seat	4.20	4.80	5.00	5.30	79.2
	Arm	1.80	2.10	2.20	2.30	36
K82LH38LAW8RTW	Entire Unit	10.40	12.00	12.50	13.00	202.3
	Back	4.50	5.20	5.40	5.60	89.7
	Seat	4.20	4.80	5.00	5.30	79.2
	Arm	1.80	2.10	2.20	2.30	36
K82LH38LAWTRAW	Entire Unit	10.40	12.00	12.50	13.00	202.3
	Back	4.50	5.20	5.40	5.60	89.7
	Seat	4.20	4.80	5.00	5.30	79.2
	Arm	1.80	2.10	2.20	2.30	36
K82LH38LTL	Entire Unit	9.60	11.00	11.50	12.00	186.8
	Back	4.50	5.20	5.40	5.60	89.7
	Seat	4.20	4.80	5.00	5.30	79.2
	Arm	1.00	1.20	1.20	1.30	20
K82LH38LTL8RAU	Entire Unit	10.50	12.10	12.60	13.10	204.3
	Back	4.50	5.20	5.40	5.60	89.7
	Seat	4.20	4.80	5.00	5.30	79.2
	Arm	1.90	2.20	2.30	2.40	36
K82LH38LTL8RTL	Entire Unit	10.50	12.10	12.60	13.10	204.3
	Back	4.50	5.20	5.40	5.60	89.7
	Seat	4.20	4.80	5.00	5.30	79.2
	Arm	1.90	2.20	2.30	2.40	36
K82LH38LTT	Entire Unit	9.60	11.00	11.50	12.00	186.8
	Back	4.50	5.20	5.40	5.60	89.7
	Seat	4.20	4.80	5.00	5.30	79.2
	Arm	1.00	1.20	1.20	1.30	20
K82LH38LTT8RAT	Entire Unit	10.40	12.00	12.50	13.00	202.3
	Back	4.50	5.20	5.40	5.60	89.7
	Seat	4.20	4.80	5.00	5.30	79.2
	Arm	1.80	2.10	2.20	2.30	36

COM YARDAGE REQUIREMENTS

COM YARDAGE REQUIREMENTS (54" WIDTH – CUT UP THE ROLL)

MODEL	RAILROADED Contact customer service 800-634-9510 for ydg requirements	NON DIRECTIONAL OR SOLID	1"-4" REPEAT	5"-11" REPEAT	12"-18" REPEAT	COL SQUARE FEET
			4" VERTICAL X 4" HORIZONTAL	11" VERTICAL X 11" HORIZONTAL	18" VERTICAL X 18" HORIZONTAL	
K82LH38LTT8RAU	Entire Unit	10.50	12.10	12.60	13.10	204.3
	Back	4.50	5.20	5.40	5.60	89.7
	Seat	4.20	4.80	5.00	5.30	79.2
	Arm	1.90	2.20	2.30	2.40	36
K82LH38LTT8RTT	Entire Unit	10.50	12.10	12.60	13.10	204.3
	Back	4.50	5.20	5.40	5.60	89.7
	Seat	4.20	4.80	5.00	5.30	79.2
	Arm	1.90	2.20	2.30	2.40	36
K82LH38LTTW	Entire Unit	9.60	11.00	11.50	12.00	186.8
	Back	4.50	5.20	5.40	5.60	89.7
	Seat	4.20	4.80	5.00	5.30	79.2
	Arm	1.00	1.20	1.20	1.30	20
K82LH38LTTW8RAU	Entire Unit	10.50	12.10	12.60	13.10	204.3
	Back	4.50	5.20	5.40	5.60	89.7
	Seat	4.20	4.80	5.00	5.30	79.2
	Arm	1.90	2.20	2.30	2.40	36
K82LH38LTTW8RAW	Entire Unit	10.40	12.00	12.50	13.00	202.3
	Back	4.50	5.20	5.40	5.60	89.7
	Seat	4.20	4.80	5.00	5.30	79.2
	Arm	1.80	2.10	2.20	2.30	36
K82LH38LTTW8RTW	Entire Unit	10.50	12.10	12.60	13.10	204.3
	Back	4.50	5.20	5.40	5.60	89.7
	Seat	4.20	4.80	5.00	5.30	79.2
	Arm	1.90	2.20	2.30	2.40	36
K82LH38RAS	Entire Unit	9.60	11.00	11.50	12.00	186.8
	Back	4.50	5.20	5.40	5.60	89.7
	Seat	4.20	4.80	5.00	5.30	79.2
	Arm	1.00	1.20	1.20	1.30	20
K82LH38RAT	Entire Unit	9.60	11.00	11.50	12.00	186.8
	Back	4.50	5.20	5.40	5.60	89.7
	Seat	4.20	4.80	5.00	5.30	79.2
	Arm	1.00	1.20	1.20	1.30	20
K82LH38RAU	Entire Unit	9.60	11.00	11.50	12.00	186.8
	Back	4.50	5.20	5.40	5.60	89.7
	Seat	4.20	4.80	5.00	5.30	79.2
	Arm	1.00	1.20	1.20	1.30	20
K82LH38RAW	Entire Unit	9.60	11.00	11.50	12.00	186.8
	Back	4.50	5.20	5.40	5.60	89.7
	Seat	4.20	4.80	5.00	5.30	79.2
	Arm	1.00	1.20	1.20	1.30	20
K82LH38RTL	Entire Unit	9.60	11.00	11.50	12.00	186.8
	Back	4.50	5.20	5.40	5.60	89.7
	Seat	4.20	4.80	5.00	5.30	79.2
	Arm	1.00	1.20	1.20	1.30	20
K82LH38RTT	Entire Unit	9.60	11.00	11.50	12.00	186.8
	Back	4.50	5.20	5.40	5.60	89.7
	Seat	4.20	4.80	5.00	5.30	79.2
	Arm	1.00	1.20	1.20	1.30	20
K82LH38RTW	Entire Unit	9.60	11.00	11.50	12.00	186.8
	Back	4.50	5.20	5.40	5.60	89.7
	Seat	4.20	4.80	5.00	5.30	79.2
	Arm	1.00	1.20	1.20	1.30	20
K82LH3TLAS	Entire Unit	9.60	11.00	11.50	12.00	186.8
	Back	4.50	5.20	5.40	5.60	89.7
	Seat	4.20	4.80	5.00	5.30	79.2
	Arm	1.00	1.20	1.20	1.30	20
K82LH3TLAS2RAS	Entire Unit	10.40	12.00	12.50	13.00	202.3
	Back	4.50	5.20	5.40	5.60	89.7
	Seat	4.20	4.80	5.00	5.30	79.2
	Arm	1.90	2.20	2.30	2.40	38

COM YARDAGE REQUIREMENTS

COM YARDAGE REQUIREMENTS (54" WIDTH – CUT UP THE ROLL)

MODEL	RAILROADED Contact customer service 800-634-9510 for ydg requirements	NON DIRECTIONAL OR SOLID	1"-4" REPEAT	5"-11" REPEAT	12"-18" REPEAT	COL SQUARE FEET
			4" VERTICAL X 4" HORIZONTAL	11" VERTICAL X 11" HORIZONTAL	18" VERTICAL X 18" HORIZONTAL	
K82LH3TLAS8RAS	Entire Unit	10.40	12.00	12.50	13.00	202.3
	Back	4.50	5.20	5.40	5.60	89.7
	Seat	4.20	4.80	5.00	5.30	79.2
	Arm	1.80	2.10	2.20	2.30	36
K82LH3TLAS8RAS	Entire Unit	10.50	12.10	12.60	13.10	204.3
	Back	4.50	5.20	5.40	5.60	89.7
	Seat	4.20	4.80	5.00	5.30	79.2
	Arm	1.90	2.20	2.30	2.40	36
K82LH3TLAT	Entire Unit	9.60	11.00	11.50	12.00	186.8
	Back	4.50	5.20	5.40	5.60	89.7
	Seat	4.20	4.80	5.00	5.30	79.2
	Arm	1.00	1.20	1.20	1.30	20
K82LH3TLAT2RAT	Entire Unit	10.40	12.00	12.50	13.00	202.3
	Back	4.50	5.20	5.40	5.60	89.7
	Seat	4.20	4.80	5.00	5.30	79.2
	Arm	1.90	2.20	2.30	2.40	38
K82LH3TLAT8RAT	Entire Unit	10.40	12.00	12.50	13.00	202.3
	Back	4.50	5.20	5.40	5.60	89.7
	Seat	4.20	4.80	5.00	5.30	79.2
	Arm	1.80	2.10	2.20	2.30	36
K82LH3TLATTRAT	Entire Unit	10.50	12.10	12.60	13.10	204.3
	Back	4.50	5.20	5.40	5.60	89.7
	Seat	4.20	4.80	5.00	5.30	79.2
	Arm	1.90	2.20	2.30	2.40	36
K82LH3TLAW	Entire Unit	9.60	11.00	11.50	12.00	186.8
	Back	4.50	5.20	5.40	5.60	89.7
	Seat	4.20	4.80	5.00	5.30	79.2
	Arm	1.00	1.20	1.20	1.30	20
K82LH3TLAW2RAW	Entire Unit	10.40	12.00	12.50	13.00	202.3
	Back	4.50	5.20	5.40	5.60	89.7
	Seat	4.20	4.80	5.00	5.30	79.2
	Arm	1.90	2.20	2.30	2.40	38
K82LH3TLAW8RAW	Entire Unit	10.40	12.00	12.50	13.00	202.3
	Back	4.50	5.20	5.40	5.60	89.7
	Seat	4.20	4.80	5.00	5.30	79.2
	Arm	1.80	2.10	2.20	2.30	36
K82LH3TLAWTRAW	Entire Unit	10.50	12.10	12.60	13.10	204.3
	Back	4.50	5.20	5.40	5.60	89.7
	Seat	4.20	4.80	5.00	5.30	79.2
	Arm	1.90	2.20	2.30	2.40	36
K82LH3TRAS	Entire Unit	9.60	11.00	11.50	12.00	186.8
	Back	4.50	5.20	5.40	5.60	89.7
	Seat	4.20	4.80	5.00	5.30	79.2
	Arm	1.00	1.20	1.20	1.30	20
K82LH3TRAT	Entire Unit	9.60	11.00	11.50	12.00	186.8
	Back	4.50	5.20	5.40	5.60	89.7
	Seat	4.20	4.80	5.00	5.30	79.2
	Arm	1.00	1.20	1.20	1.30	20
K82LH3TRAW	Entire Unit	9.60	11.00	11.50	12.00	186.8
	Back	4.50	5.20	5.40	5.60	89.7
	Seat	4.20	4.80	5.00	5.30	79.2
	Arm	1.00	1.20	1.20	1.30	20

