

TEXCAN

A Sonepar Company



TRAY CABLE

CATALOGUE

WHY CHOOSE TEXCAN?

Our expertise lies in providing solutions tailored to each customer's individual needs. Texcan has been a leader in the wire and cable industry since 1978, consistently going above and beyond to serve our customers. As one of the largest wire and cable suppliers in Canada, Texcan specializes in serving the electrical market and offers an extensive range of products and specialized services.

LOCAL INVENTORY WHAT YOU WANT, WHEN YOU NEED IT!

Texcan takes pride in our extensive inventory, offering a diverse selection of wire and cable options to meet customers' specific requirements. We prioritize convenience, ensuring that our customers have easy access to the products they need, when they need them.

LOCAL EXPERTISE WITH A GLOBAL PRESENCE

Texcan is a proud member of the Sonepar Group. Founded in 1969, the Sonepar Group of companies is an independent family-owned company and global market leader in B to B distribution of electrical products, solutions, and related services.

PRODUCT SOURCING

Texcan's preferred partners are selected based on their reputation for excellence, reliability, and expertise in their respective fields. These partnerships are built on mutual trust, shared values, and a commitment to delivering exceptional customer experiences. By collaborating with industry-leading manufacturers and suppliers, Texcan ensures that it consistently offers outstanding products and solutions to its diverse customer base.



LIVE 24/7, 365 DAY EMERGENCY SUPPORT

Texcan recognizes the crucial importance of continuous, year-round operations. We understand that during emergencies, disruptions can pose significant risks and expenses. That's why we are fully committed to delivering prompt assistance whenever it is required. Our dedicated team is available 24/7 to provide live help, ensuring that your operations can swiftly resume without any unnecessary delays. To access our live assistance, simply call our toll-free number, 1.800.665.1025.

We are ready to provide the support you need, anytime, anywhere.



ENGINEERING SUPPORT

By choosing Texcan, you gain access to our dedicated in-house engineering and product management team, along with manufacturer support for your project. The sooner you engage us, the greater the value we can provide.

When you collaborate with us, we can assist in reviewing your bill of materials, ensuring accuracy and efficiency. Our team specializes in streamlining cabling specifications, optimizing designs, and technical compliance throughout the project lifecycle. Our expertise allows us to streamline processes and enhance overall project efficiency.

TABLE OF CONTENTS

	Page No.
Tray Cable	4
Standard Design Features - Control and Power Tray	5
Standard Design Features - Instrumentation Tray	6
FR XLPE Control 600V - 14 AWG	7
- 12 AWG	8
- 10 AWG	8
- 8 AWG	9
- 6 AWG	9
- 4 AWG	9
- 2 AWG	9
FR XLPE Power 2C 1000V	10
FR XLPE Power 3C 1000V	11
FR XLPE Power 4C 1000V	12
Instrumentation IS/OS XLPE Tray - 20 AWG 300V	13
- 18 AWG 300V	14
- 16 AWG 300V	15
Instrumentation OS XLPE Tray - 20 AWG 300V	16
- 18 AWG 300V	17
- 16 AWG 300V	18
- 18 AWG 600V	19
- 16 AWG 600V	19
- 14 AWG 600V	19
Tray Connectors	20

To Place an Order - For many of the products in the catalogue, you will find everything that you need to place an order. Should you need any assistance or require special orders, please contact your sales representative. A complete list of our sales offices can be found on the back cover of this catalogue.

Introduction

Tray cable is a multi-conductor or multi-pair or triad control, signal or power cable specifically approved under the Canadian Electrical Code for installation in trays. It provides the needed flexibility in circuit layouts in various industrial establishments, such as petrochemical, power generation, pulp and paper, mining, wastewater treatment, food processing and transportation.

The CSA approved tray cable category includes control and power cables, and instrumentation cables with flame-retardant insulation (XLPE or PVC). Tray cable is moisture and sunlight resistant, is FT4 rated and is suitable for direct burial installation. It has a nylon rip cord for jacket removal.

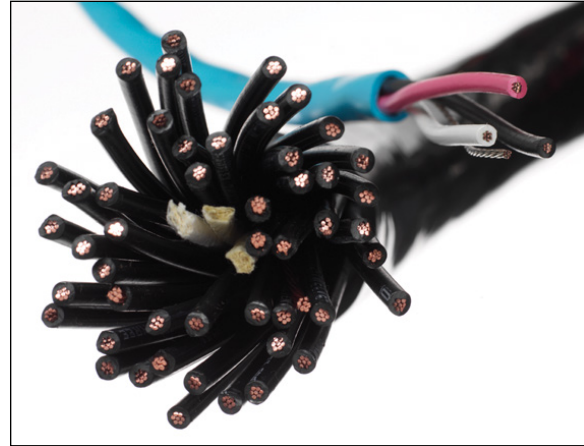

Applications

Control and Power Tray Cable

Designed for wet or dry locations, the control cable can be installed in cable tray, duct and conduit or it can be used in a direct burial application. It has soft-annealed bare copper conductors, flame-retardant insulation (XLPE) and PVC jacket. The maximum jacket temperature is 90°C and the low temperature rating is -40°C. Shielded cable options are also available.

Instrumentation Tray Cable

The instrumentation cable construction uses soft-annealed tinned copper conductors with flame-retardant insulation (XLPE or PVC) and an overall PVC jacket. It is suitable for installation in wet or dry locations. The cable is overall shielded or individual (pair or triad shielded) and overall shielded to reduce electrical interference and cross talk. Non-shielded cable is also available as an option. All sizes come in either multi-pair or triads.

Specifications

- CSA C22.2 No. 230 Tray Cable
- CSA C22.2 No. 239 Control and Instrumentation
- CSA C22.2 No. 75, Thermoplastic Insulated Conductors
- CSA C22.2 No. 38, Thermoset Insulated Conductors
- CSA FT4 rated (70,000 BTU Vertical Flame Test)
- Suitable for installation in Hazardous Location:
 - Class 1, Zone 2 (Division 2)
 - Class II, Division 2
- Sunlight/UV Resistant
- Direct Burial
- PVC Insulation - rated 105°C (dry), 75°C (wet) and -25°C
- XLPE Insulation - rated 105°C (dry), 90°C (wet) and -40°C

CAUTION NOTICE

In case of fire, well maintained early warning smoke detectors will give an alarm long before non-metallic coverings become combustible. However, the Electrical and Electronic Manufacturers Association of Canada has suggested that all purchasers of PVC insulated / jacketed products be advised of the following:

- Non-metallic coverings of electrical cables can burn and may transmit fire when ignited.
- Burning non-metallic coverings may emit acid gases which are toxic and may generate dense smoke.
- Emission of acid gases may corrode metal in the vicinity e.g. sensitive instruments and reinforcing rods in cement.

The installer and/or user assumes all liability for the consequences of the installation and/or use of any of the products in violation of any applicable law, regulation, or code.

Control and Power Tray

Conductors - Class B concentric stranded soft annealed bare copper.

Insulation

- Flame-retardant (FR) Cross-Linked Polyethylene (XLPE) in accordance with CSA Standards C22.2 No. 239 and C22.2 No. 38.
- Polyvinyl Chloride (PVC) in accordance with CSA Standards C22.2 No. 239 and C22.2 No. 75.

Bonding (Ground) Conductor - Class B stranded soft bare copper conductor is included in the assembled cable for multiconductor cables.

Fillers and Core Binder Tape - Where required, suitable fillers to make round and core binders may be used.

Jacket Separator Tape - Clear polyester jacket separator tape is used to hold the conductors in place.

Jacket - 90°C to -40°C, flame-retardant (FR), moisture and sunlight resistant PVC FT4 jacket is applied over the core. A nylon ripcord is included for jacket removal. Standard jacket colour is black.

Colour Code

Conductor Colour Code:

- 2 conductor cables - Black and white
- 3 conductor cables - Black, red and blue
- 4 conductor cables - Black, red, blue and white
- 5 or more conductor cables - Black and alpha numeric coded

Options

- 300V or 600V Control cables
- Aluminum/polyester or tinned copper braid shielded cables
- Coloured outer jacket
- Connectors available upon request
- Other constructions available upon request

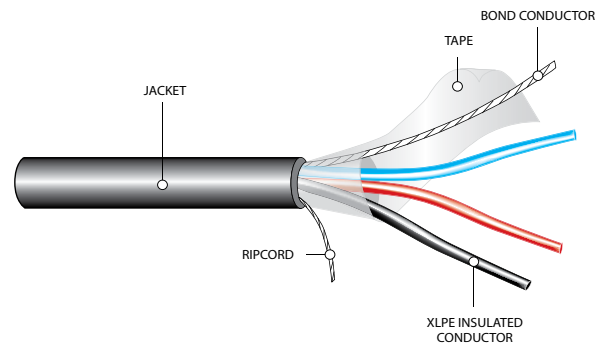

Instrumentation Tray

Conductors - Class B concentric stranded soft annealed tinned copper.

Insulation

- Fire-retardant (FR) Cross-Linked Polyethylene (XLPE) in accordance with CSA Standards C22.2 No. 239 and C22.2 No. 38.
- Polyvinyl Chloride (PVC) in accordance with CSA Standards C22.2 No. 239 and C22.2 No. 75.

Individual Shield - Aluminum foil-polyester tape with stranded tinned copper drain wire for each pair or triad.

Overall Shield - Aluminum foil-polyester tape with seven strand tinned copper drain wire.

Jacket - A low temperature (-40°C), flame-retardant (FR), moisture and sunlight resistant PVC jacket is applied over the core. A nylon ripcord is included for jacket removal. Standard jacket colour is black.

Colour Code

Conductor Colour Code:

- Pairs – Black, white and alpha numeric coded
- Triads – Black, white, red and alpha numeric coded

Options

- 150V, 300V and 600V cables
- 14 AWG cables
- Unshielded or tinned copper braid shielded cables
- Coloured outer jacket
- Connectors available upon request
- Other constructions available upon request

IS/OS

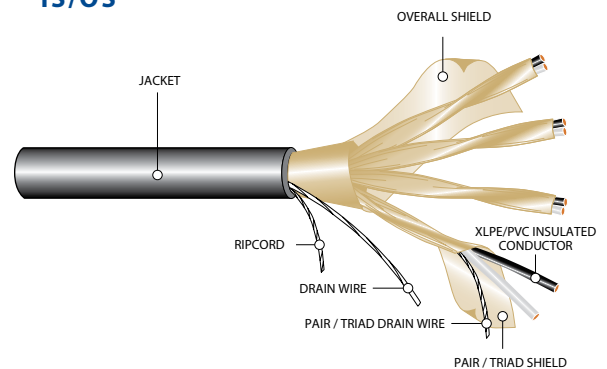

OS

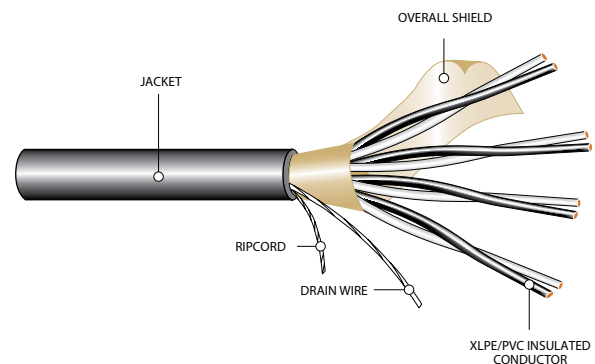

FR XLPE Insulated Control 14 AWG 600V

XLPE/PVC

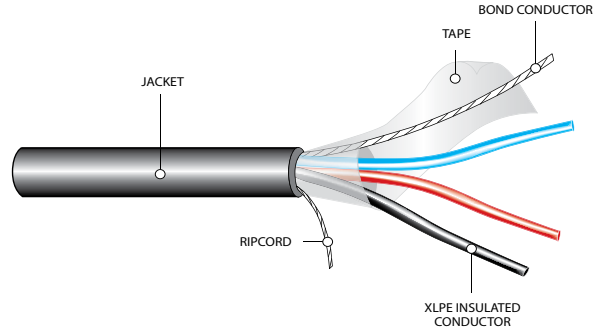

SPECIFICATIONS

- CSA C22.2 No. 230
- CSA C22.2 No. 239
- CSA 22.2 No. 38
- CSA FT4 (70,000 BTU Vertical Tray Flame Test)

*refer to CE Code for details



CONSTRUCTION

Conductor: 7 strand bare Class B concentric copper

Insulation: Flame retardant (FR) Cross-Linked Polyethylene (XLPE), Type RW90

Ground (Bonding) Conductor: 7 strand bare copper conductor

Fillers and Core Binder Tape: Fillers may be used to make the cable round and clear polyester binder tape is used to hold the conductors in place

Outer Jacket: Low-temperature (-40°C), flame and sunlight resistant Polyvinyl Chloride (PVC), black

Options: 300V Control Cable

Polyvinyl Chloride (PVC) insulation

Aluminum/polyester shielded cables available

Tinned conductors

Other coloured outer jacket and constructions available upon request

Tinned copper braid shielded cables are available upon request

14 AWG					
Part Number	No. of Conductors	Insulation Thickness (in.)	Approximate Diameter (in.)	Net Weight	
				LB/MFT	KG/KM
12701-02-014	2	0.030	0.374	86	128
12701-03-014	3	0.030	0.397	105	157
12701-04-014	4	0.030	0.431	127	189
12701-05-014	5	0.030	0.471	148	220
12701-06-014	6	0.030	0.513	170	253
12701-07-014	7	0.030	0.513	180	268
12701-08-014	8	0.030	0.587	226	337
12701-10-014	10	0.030	0.671	272	405
12701-12-014	12	0.030	0.705	310	462
12701-15-014	15	0.030	0.759	366	545
12701-20-014	20	0.030	0.891	502	747
12701-25-014	25	0.030	1.001	609	906
12701-30-014	30	0.030	1.063	711	1058
12701-40-014	40	0.030	1.182	911	1355
12701-50-014	50	0.030	1.302	1113	1656

Note: All dimensions are nominal and are subject to normal manufacturing tolerance. Specifications are subject to change without prior notice.

* See page 20 for corresponding connectors.

FR XLPE Insulated Control 12 AWG & 10 AWG 600V

XLPE/PVC

SPECIFICATIONS

- CSA C22.2 No. 230
- CSA C22.2 No. 239
- CSA 22.2 No. 38
- CSA FT4 (70,000 BTU Vertical Tray Flame Test)

*refer to CE Code for details



CONSTRUCTION

Conductor: 7 strand bare Class B concentric copper

Insulation: Flame retardant (FR) Cross-Linked Polyethylene (XLPE), Type RW90

Ground (Bonding) Conductor: 7 strand bare copper conductor

Fillers and Core Binder Tape: Fillers may be used to make the cable round and clear polyester binder tape is used to hold the conductors in place

Outer Jacket: Low-temperature (-40°C), flame and sunlight resistant Polyvinyl Chloride (PVC), black

Options: 300V Control Cable

Polyvinyl Chloride (PVC) insulation

Aluminum/polyester shielded cables available

Tinned conductors

Other coloured outer jacket and constructions available upon request

Tinned copper braid shielded cables are available upon request

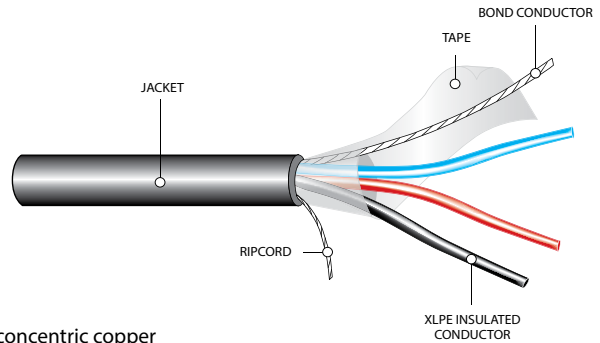

12 AWG					
Part Number	No. of Conductors	Insulation Thickness (in.)	Approximate Diameter (in.)	Net Weight	
				LB/MFT	KG/KM
12702-02-014	2	0.030	0.413	107	159
12702-03-014	3	0.030	0.439	131	195
12702-04-014	4	0.030	0.478	165	246
12702-06-014	6	0.030	0.602	239	356
12702-10-014	10	0.030	0.748	345	514
12702-12-014	12	0.030	0.785	410	610
12702-15-014	15	0.030	0.887	538	801
12702-20-014	20	0.030	0.992	696	1035
12702-25-014	25	0.030	1.117	846	1258
12702-30-014	30	0.030	1.187	1001	1490

10 AWG					
Part Number	No. of Conductors	Insulation Thickness (in.)	Approximate Diameter (in.)	Net Weight	
				LB/MFT	KG/KM
12703-02-014	2	0.030	0.466	144	215
12703-03-014	3	0.030	0.496	188	280
12703-04-014	4	0.030	0.572	242	360
12703-06-014	6	0.030	0.681	362	539
12703-08-014	8	0.030	0.721	416	619
12703-10-014	10	0.030	0.893	550	818
12703-12-014	12	0.030	0.915	615	915
12703-15-014	15	0.030	1.009	840	1250
12703-20-014	20	0.030	1.130	999	1487
12703-30-014	30	0.030	1.319	1389	2067
12703-40-014	40	0.080	1.474	1809	2692

Note: All dimensions are nominal and are subject to normal manufacturing tolerance. Specifications are subject to change without prior notice.

* See page 20 for corresponding connectors.

FR XLPE Insulated Control 8 AWG, 6 AWG, 4 AWG & 2 AWG 600V

XLPE/PVC

SPECIFICATIONS

- CSA C22.2 No. 230
- CSA C22.2 No. 239
- CSA 22.2 No. 38
- CSA FT4 (70,000 BTU Vertical Tray Flame Test)

*refer to CE Code for details



CONSTRUCTION

Conductor: 7 strand bare Class B concentric copper

Insulation: Flame retardant (FR) Cross-Linked Polyethylene (XLPE), Type RW90

Ground (Bonding) Conductor: 7 strand bare copper conductor

Fillers and Core Binder Tape: Fillers may be used to make the cable round and clear polyester binder tape is used to hold the conductors in place

Outer Jacket: Low-temperature (-40°C), flame and sunlight resistant Polyvinyl Chloride (PVC), black

Options: 300V Control Cable

Polyvinyl Chloride (PVC) insulation

Aluminum/polyester shielded cables available

Tinned conductors

Other coloured outer jacket and constructions available upon request

Tinned copper braid shielded cables are available upon request

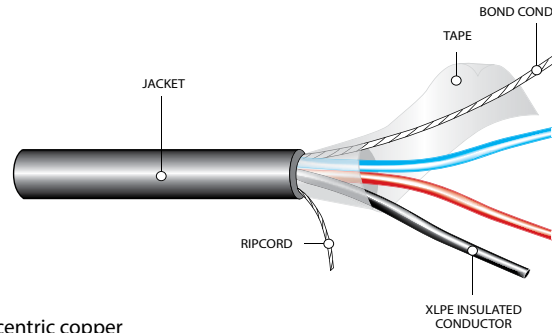

8 AWG					
Part Number	No. of Conductors	Insulation Thickness (in.)	Approximate Diameter (in.)	Net Weight	
				LB/MFT	KG/KM
12704-02-014	2	0.045	0.606	222	330
12704-03-014	3	0.045	0.659	319	475
12704-04-014	4	0.045	0.72	377	561
6 AWG					
12705-02-014	2	0.045	0.686	315	469
12705-03-014	3	0.045	0.736	373	555
4 AWG					
12706-02-014	2	0.045	0.783	430	640
12706-03-014	3	0.045	0.881	621	924
2 AWG					
12707-03-014	3	0.045	0.956	928	1381

Note: All dimensions are nominal and are subject to normal manufacturing tolerance. Specifications are subject to change without prior notice.

* See page 20 for corresponding connectors.

FR XLPE Insulated Power Two Conductor 1000V

XLPE/PVC

SPECIFICATIONS

- CSA C22.2 No. 230
- CSA C22.2 No. 38
- CSA FT4 (70,000 BTU Vertical Tray Flame Test)

*refer to CE Code for details



CONSTRUCTION

Conductor: 7 strand bare Class B concentric copper

Insulation: Flame retardant (FR) Cross-Linked Polyethylene (XLPE), Type RW90

Ground (Bonding) Conductor: Stranded bare copper conductor

Fillers and Core Binder Tape: Fillers may be used to make the cable round and clear polyester binder tape is used to hold the conductors in place

Outer Jacket: Low-temperature (-40°C), flame and sunlight resistant Polyvinyl Chloride (PVC), black

Options: 600V power cable

Polyvinyl Chloride (PVC) insulation

Tinned conductors

Other coloured outer jacket and conductor gauge sizes available upon request

Tinned copper braid shielded cables are available upon request

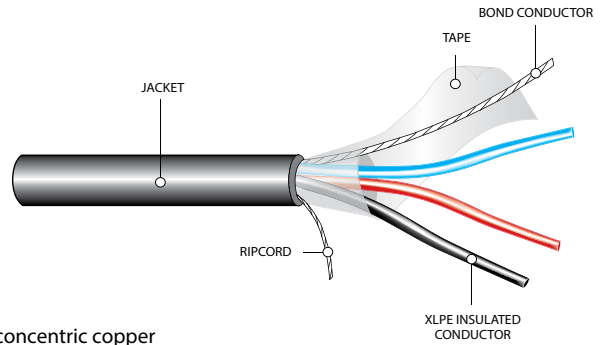

Part Number	Conductors AWG Size	Insulation Thickness (in.)	Approximate Diameter (in.)	Net Weight	
				LB/MFT	KG/KM
12701-02-013	14	0.045	0.436	89	133
12702-02-013	12	0.045	0.476	112	166
12703-02-013	10	0.045	0.516	147	218
12704-02-013	8	0.045	0.619	241	359
12705-02-013	6	0.060	0.760	347	516
12706-02-013	4	0.060	0.901	499	743
12707-02-013	2	0.080	1.025	718	1068
12710-02-013	2/0	0.080	1.261	1229	1829

Note: All dimensions are nominal and are subject to normal manufacturing tolerance.
Specifications are subject to change without prior notice.

* See page 20 for corresponding connectors.

FR XLPE Insulated Power Three Conductor 1000V

XLPE/PVC

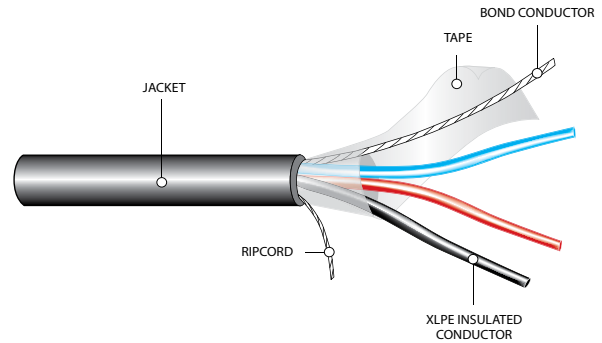

SPECIFICATIONS

- CSA C22.2 No. 230
- CSA C22.2 No. 38
- CSA FT4 (70,000 BTU Vertical Tray Flame Test)

*refer to CE Code for details



CONSTRUCTION

Conductor: Stranded bare Class B concentric copper

Insulation: Flame retardant (FR) Cross-Linked Polyethylene (XLPE), Type RW90

Ground (Bonding) Conductor: Stranded bare copper conductor

Fillers and Core Binder Tape: Fillers may be used to make the cable round and clear polyester binder tape is used to hold the conductors in place

Outer Jacket: Low-temperature (-40°C), flame and sunlight resistant Polyvinyl Chloride (PVC), black

Options: 600V power cable

Polyvinyl Chloride (PVC) insulation

Tinned conductors

Other coloured outer jacket and constructions available upon request

Tinned copper braid shielded cables are available upon request

Part Number	Conductors AWG Size	Insulation Thickness (in.)	Approximate Diameter (in.)	Net Weight	
				LB/MFT	KG/KM
12701-03-013	14	0.045	0.463	118	176
12702-03-013	12	0.045	0.507	153	228
12703-03-013	10	0.045	0.593	218	324
12704-03-013	8	0.045	0.659	311	463
12705-03-013	6	0.060	0.881	463	689
12706-03-013	4	0.060	0.959	686	1021
12707-03-013	2	0.060	1.093	976	1452
12708-03-013	1	0.080	1.251	1188	1768
12709-03-013	1/0	0.080	1.340	1454	2163
12710-03-013	2/0	0.080	1.443	1759	2617
12711-03-013	3/0	0.080	1.554	2022	3009
12712-03-013	4/0	0.080	1.743	2637	3924
12713-03-013	250	0.090	1.835	3132	4661
12714-03-013	350	0.090	2.057	4250	6324
12715-03-013	500	0.090	2.332	5783	8606

Note: All dimensions are nominal and are subject to normal manufacturing tolerance.
Specifications are subject to change without prior notice.

* See page 20 for corresponding connectors.

FR XLPE Insulated Power Four Conductor 1000V

XLPE/PVC

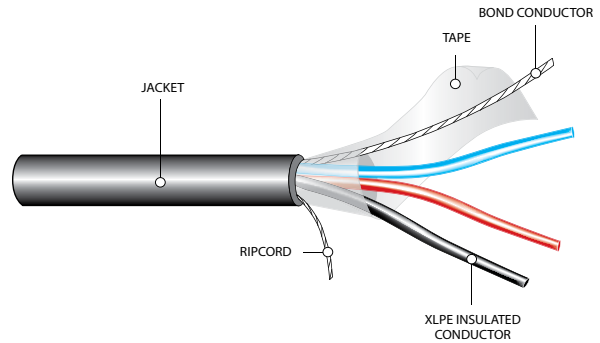

SPECIFICATIONS

- CSA C22.2 No. 230
- CSA C22.2 No. 38
- CSA FT4 (70,000 BTU Vertical Tray Flame Test)

*refer to CE Code for details



CONSTRUCTION

Conductor: 7 strand bare Class B concentric copper

Insulation: Flame retardant (FR) Cross-Linked Polyethylene (XLPE), Type RW90

Ground (Bonding) Conductor: Stranded bare copper conductor

Fillers and Core Binder Tape: Fillers may be used to make the cable round and clear polyester binder tape is used to hold the conductors in place

Outer Jacket: Low-temperature (-40°C), flame and sunlight resistant Polyvinyl Chloride (PVC), black

Options: 600V power cable

Polyvinyl Chloride (PVC) insulation

Tinned conductors

Other coloured outer jacket and conductor gauge sizes available upon request

Tinned copper braid shielded cables are available upon request

Part Number	Conductors AWG Size	Insulation Thickness (in.)	Approximate Diameter (in.)	Net Weight	
				LB/MFT	KG/KM
12701-04-013	14	0.045	0.505	140	208
12702-04-013	12	0.045	0.574	186	277
12703-04-013	10	0.045	0.647	267	398
12704-04-013	8	0.045	0.720	413	614
12705-04-013	6	0.060	0.930	612	910
12706-04-013	4	0.060	1.051	848	1261
12707-04-013	2	0.060	1.201	1238	1842
12709-04-013	1/0	0.080	1.386	1856	2762
12710-04-013	2/0	0.080	1.486	2239	3332
12712-04-013	4/0	0.080	1.79	3491	5195

Note: All dimensions are nominal and are subject to normal manufacturing tolerance.
Specifications are subject to change without prior notice..

* See page 20 for corresponding connectors.

XLPE Insulated Individual and Overall Shielded 20 AWG 300V

XLPE/PVC

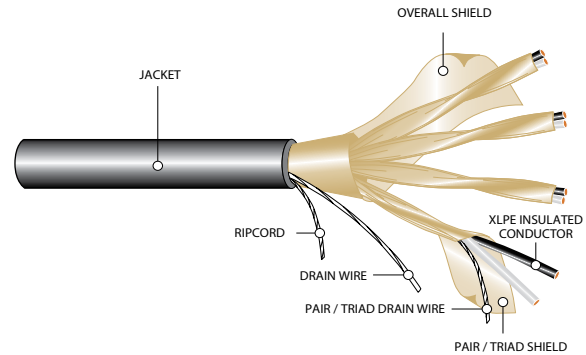

SPECIFICATIONS

- CSA C22.2 No. 230
- CSA C22.2 No. 239
- CSA C22.2 No. 38
- CSA FT4 rated (70,000 BTU Vertical Flame Test)

*refer to CE Code for details



CONSTRUCTION

Conductor: 7 strand tinned Class B concentric copper

Insulation: Flame retardant (FR) Cross-Linked Polyethylene (XLPE), Type RW90

Individual Shield: Aluminum/polyester tape shield with 7 strand drain wire over each pair or triad

Overall Shield: Overall aluminum/polyester tape shield with 7 strand drain wire

Outer Jacket: Low-temperature (-40°C), flame and sunlight resistant Polyvinyl Chloride (PVC), black

Options: Tinned copper braid shielded cables are available upon request

150V cable

Polyvinyl Chloride (PVC) insulation

Other coloured outer jacket and constructions available upon request

Overall shielded only

PAIRS

Part Number	No. of Pairs	Insulation Thickness (in.)	Approximate Diameter (in.)	Net Weight		Min. Bend Radius (in.)
				LB/MFT	KG/KM	
C3-1324-2002-11	2	0.020	0.298	48	71	3.5
C3-1324-2004-11	4	0.020	0.452	87	129	5.4
C3-1324-2008-11	8	0.020	0.614	165	245	7.3
C3-1324-2012-11	12	0.020	0.738	230	342	8.8
C3-1324-2016-11	16	0.020	0.816	290	432	9.7
C3-1324-2024-11	24	0.020	1.018	446	664	12.2
C3-1324-2036-11	36	0.020	1.192	627	933	14.3
C3-1324-2050-11	50	0.020	1.672	1068	1589	20.0

TRIADS

Part Number	No. of Pairs	Insulation Thickness (in.)	Approximate Diameter (in.)	Net Weight		Min. Bend Radius (in.)
				LB/MFT	KG/KM	
C3-1334-2002-11	2	0.020	0.420	69	102	5.0
C3-1334-2004-11	4	0.020	0.486	111	165	5.8
C3-1334-2008-11	8	0.020	0.660	212	316	7.9
C3-1334-2012-11	12	0.020	0.795	300	447	9.5
C3-1334-2016-11	16	0.020	0.922	415	617	11.0
C3-1334-2024-11	24	0.020	1.099	587	874	13.0

Note: All dimensions are nominal and are subject to normal manufacturing tolerance. Specifications are subject to change without prior notice

* See page 20 for corresponding connectors.

XLPE Insulated Individual and Overall Shielded 18 AWG 300V

XLPE/PVC

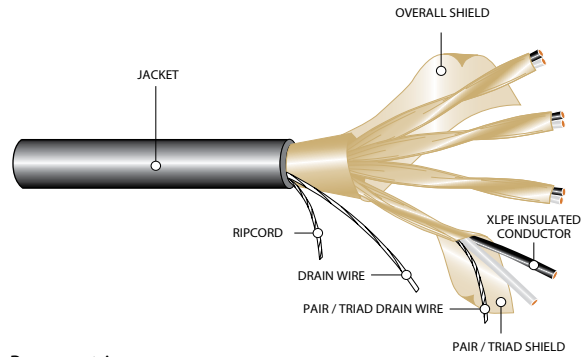

SPECIFICATIONS

- CSA C22.2 No. 230
- CSA C22.2 No. 239
- CSA C22.2 No. 38
- CSA FT4 rated (70,000 BTU Vertical Flame Test)

*refer to CE Code for details



CONSTRUCTION

- Conductor:** 7 strand tinned Class B concentric copper
- Insulation:** Flame retardant (FR) Cross-Linked Polyethylene (XLPE), Type RW90
- Individual Shield:** Aluminum/polyester tape shield with 7 strand drain wire over each pair or triad
- Overall Shield:** Overall aluminum/polyester tape shield with 7 strand drain wire
- Outer Jacket:** Low-temperature (-40°C), flame and sunlight resistant Polyvinyl Chloride (PVC), black
- Options:** Tinned copper braid shielded cables are available upon request
150V or 600V cable
Polyvinyl Chloride (PVC) insulation
Other coloured outer jacket and constructions available upon request
Overall shielded only

PAIRS						
Part Number	No. of Pairs	Insulation Thickness (in.)	Approximate Diameter (in.)	Net Weight		Min. Bend Radius (in.)
				LB/MFT	KG/KM	
C3-1324-1802-11	2	0.025	0.347	65	96	4.0
C3-1324-1804-11	4	0.025	0.555	132	196	6.6
C3-1324-1808-11	8	0.025	0.713	226	336	8.5
C3-1324-1812-11	12	0.025	0.902	349	520	10.8
C3-1324-1816-11	16	0.025	0.997	440	655	11.9
C3-1324-1824-11	24	0.025	1.192	623	927	14.3
C3-1324-1836-11	36	0.025	1.401	884	1315	16.8
C3-1324-1850-11	50	0.025	1.880	1497	2227	22.5

TRIADS						
Part Number	No. of Pairs	Insulation Thickness (in.)	Approximate Diameter (in.)	Net Weight		Min. Bend Radius (in.)
				LB/MFT	KG/KM	
C3-1334-1802-11	2	0.025	0.499	94	140	5.9
C3-1334-1804-11	4	0.025	0.611	171	255	7.3
C3-1334-1808-11	8	0.025	0.790	302	449	9.4
C3-1334-1812-11	12	0.025	0.999	466	693	11.9
C3-1334-1816-11	16	0.025	1.107	592	881	13.2
C3-1334-1824-11	24	0.025	1.327	847	1260	15.9

Note: All dimensions are nominal and are subject to normal manufacturing tolerance. Specifications are subject to change without prior notice

* See page 20 for corresponding connectors.

XLPE Insulated Individual and Overall Shielded 16 AWG 300V

XLPE/PVC

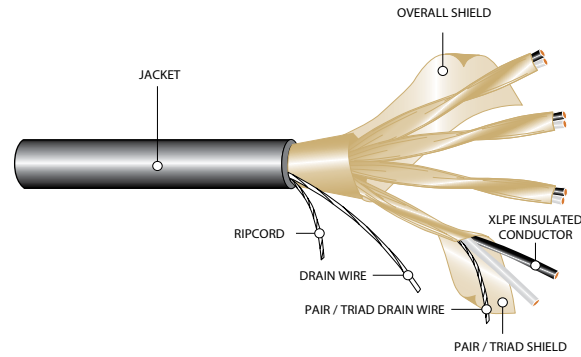

SPECIFICATIONS

- CSA C22.2 No. 230
- CSA C22.2 No. 239
- CSA C22.2 No. 38
- CSA FT4 rated (70,000 BTU Vertical Flame Test)

*refer to CE Code for details



CONSTRUCTION

- Conductor:** 7 strand tinned Class B concentric copper
- Insulation:** Flame retardant (FR) Cross-Linked Polyethylene (XLPE), Type RW90
- Individual Shield:** Aluminum/polyester tape shield with 7 strand drain wire over each pair or triad
- Overall Shield:** Overall aluminum/polyester tape shield with 7 strand drain wire
- Outer Jacket:** Low-temperature (-40°C), flame and sunlight resistant Polyvinyl Chloride (PVC), black
- Options:** Tinned copper braid shielded cables are available upon request
 - 150V or 600V cable
 - Polyvinyl Chloride (PVC) insulation
 - Other coloured outer jacket and constructions available upon request
 - Overall shielded only

PAIRS

Part Number	No. of Pairs	Insulation Thickness (in.)	Approximate Diameter (in.)	Net Weight		Min. Bend Radius (in.)
				LB/MFT	KG/KM	
C3-1324-1602-11	2	0.025	0.371	82	122	4.4
C3-1324-1604-11	4	0.025	0.605	167	248	7.2
C3-1324-1606-11	6	0.025	0.721	232	346	8.7
C3-1324-1608-11	8	0.025	0.782	292	434	9.3
C3-1324-1612-11	12	0.025	0.989	450	669	11.8
C3-1324-1616-11	16	0.025	1.095	571	849	13.1
C3-1324-1624-11	24	0.025	1.313	814	1211	15.7
C3-1324-1636-11	36	0.025	1.546	1165	1733	18.5

TRIADS

Part Number	No. of Pairs	Insulation Thickness (in.)	Approximate Diameter (in.)	Net Weight		Min. Bend Radius (in.)
				LB/MFT	KG/KM	
C3-1334-1602-11	2	0.025	0.568	133	198	6.8
C3-1334-1604-11	4	0.025	0.658	218	325	7.8
C3-1334-1608-11	8	0.025	0.895	422	628	10.7
C3-1334-1612-11	12	0.025	1.081	600	893	12.9
C3-1334-1616-11	16	0.025	1.199	769	1144	14.3
C3-1334-1624-11	24	0.025	1.442	1108	1648	17.3

Note: All dimensions are nominal and are subject to normal manufacturing tolerance. Specifications are subject to change without prior notice

* See page 20 for corresponding connectors.

XLPE Insulated Overall Shielded 20 AWG 300V

XLPE/PVC

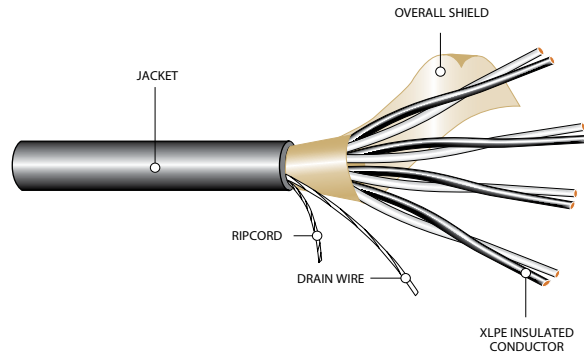

SPECIFICATIONS

- CSA C22.2 No. 230
- CSA C22.2 No. 239
- CSA C22.2 No. 38
- CSA FT4 rated (70,000 BTU Vertical Flame Test)

*refer to CE Code for details



CONSTRUCTION

Conductor: 7 strand tinned Class B concentric copper
Insulation: Flame retardant (FR) Cross-Linked Polyethylene (XLPE), Type RW90
Overall Shield: Overall aluminum/polyester tape shield with 7 strand drain wire
Outer Jacket: Low-temperature (-40°C), flame and sunlight resistant Polyvinyl Chloride (PVC), black
Options: Tinned copper braid shielded cables are available upon request
 Polyvinyl Chloride (PVC) insulation
 Other coloured outer jacket and constructions available upon request
 Individual and overall shields

PAIRS

Part Number	No. of Pairs	Insulation Thickness (in.)	Approximate Diameter (in.)	Net Weight		Min. Bend Radius (in.)
				LB/MFT	KG/KM	
C3-1124-2001-11	1	0.020	0.256	30	44	3.0
C3-1224-2002-11	2	0.020	0.298	48	71	3.5
C3-1224-2004-11	4	0.020	0.420	75	111	5.0
C3-1224-2008-11	8	0.020	0.578	142	211	6.9
C3-1224-2012-11	12	0.020	0.642	191	284	7.7
C3-1224-2016-11	16	0.020	0.739	244	363	8.8
C3-1224-2024-11	24	0.020	0.918	375	558	11.0
C3-1224-2036-11	36	0.020	1.061	523	778	12.7
C3-1224-2050-11	50	0.020	1.586	896	1334	19.0

TRIADS

Part Number	No. of Pairs	Insulation Thickness (in.)	Approximate Diameter (in.)	Net Weight		Min. Bend Radius (in.)
				LB/MFT	KG/KM	
C3-1134-2001-11	1	0.020	0.269	36	54	3.2
C3-1234-2002-11	2	0.020	0.411	64	95	4.9
C3-1234-2004-11	4	0.020	0.475	101	151	5.7
C3-1234-2008-11	8	0.020	0.645	194	283	7.7
C3-1234-2012-11	12	0.020	0.777	273	406	9.3
C3-1234-2016-11	16	0.020	0.901	378	562	10.8
C3-1234-2024-11	24	0.020	1.073	532	792	12.8

Note: All dimensions are nominal and are subject to normal manufacturing tolerance.
 Specifications are subject to change without prior notice

* See page 20 for corresponding connectors.

XLPE Insulated Overall Shielded 18 AWG 300V

XLPE/PVC

SPECIFICATIONS

- CSA C22.2 No. 230
- CSA C22.2 No. 239
- CSA C22.2 No. 38
- CSA FT4 rated (70,000 BTU Vertical Flame Test)

*refer to CE Code for details



CONSTRUCTION

Conductor: 7 strand tinned Class B concentric copper
Insulation: Flame retardant (FR) Cross-Linked Polyethylene (XLPE), Type RW90
Overall Shield: Overall aluminum/polyester tape shield with 7 strand drain wire
Outer Jacket: Low-temperature (-40°C), flame and sunlight resistant Polyvinyl Chloride (PVC), black
Options: Tinned copper braid shielded cables are available upon request
 Polyvinyl Chloride (PVC) insulation
 Other coloured outer jacket and constructions available upon request
 600V
 Individual and overall shields

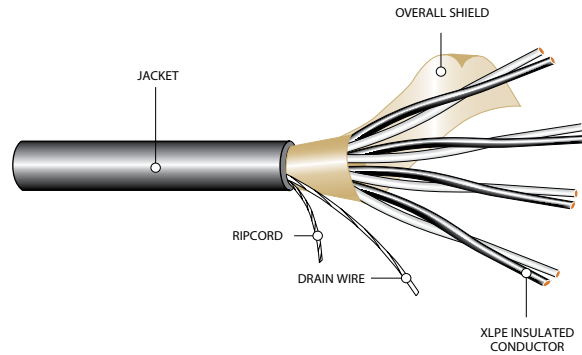

PAIRS

Part Number	No. of Pairs	Insulation Thickness (in.)	Approximate Diameter (in.)	Net Weight		Min. Bend Radius (in.)
				LB/MFT	KG/KM	
C3-1124-1801-11	1	0.025	0.296	42	63	3.5
C3-1224-1802-11	2	0.025	0.347	65	96	4.1
C3-1224-1804-11	4	0.025	0.501	106	157	6.0
C3-1324-1806-11	6	0.025	0.658	181	270	8.0
C3-1224-1808-11	8	0.025	0.691	204	303	8.2
C3-1224-1812-11	12	0.025	0.771	279	415	9.2
C3-1224-1816-11	16	0.025	0.954	391	582	11.4
C3-1224-1824-11	24	0.025	1.107	550	819	13.2
C3-1224-1836-11	36	0.025	1.287	778	1157	15.4
C3-1224-1850-11	50	0.025	1.790	1258	1873	21.4

TRIADS

Part Number	No. of Pairs	Insulation Thickness (in.)	Approximate Diameter (in.)	Net Weight		Min. Bend Radius (in.)
				LB/MFT	KG/KM	
C3-1134-1801-11	1	0.025	0.312	51	76	3.7
C3-1234-1802-11	2	0.025	0.490	89	133	5.8
C3-1234-1804-11	4	0.025	0.600	162	241	7.2
C3-1234-1808-11	8	0.025	0.775	284	422	9.3
C3-1234-1812-11	12	0.025	0.980	438	651	11.7
C3-1234-1816-11	16	0.025	1.085	555	826	13.0
C3-1234-1824-11	24	0.025	1.301	792	1178	15.6

Note: All dimensions are nominal and are subject to normal manufacturing tolerance. Specifications are subject to change without prior notice

* See page 20 for corresponding connectors.

OS XLPE

XLPE Insulated Overall Shielded 16 AWG 300V

XLPE/PVC

SPECIFICATIONS

- CSA C22.2 No. 230
- CSA C22.2 No. 239
- CSA C22.2 No. 38
- CSA FT4 rated (70,000 BTU Vertical Flame Test)

*refer to CE Code for details



CONSTRUCTION

Conductor: 7 strand tinned Class B concentric copper
Insulation: Flame retardant (FR) Cross-Linked Polyethylene (XLPE), Type RW90
Overall Shield: Overall aluminum/polyester tape shield with 7 strand drain wire
Outer Jacket: Low-temperature (-40°C), flame and sunlight resistant Polyvinyl Chloride (PVC), black
Options: Tinned copper braid shielded cables are available upon request
 Polyvinyl Chloride (PVC) insulation
 Other coloured outer jacket and constructions available upon request
 600V
 Individual and overall shields

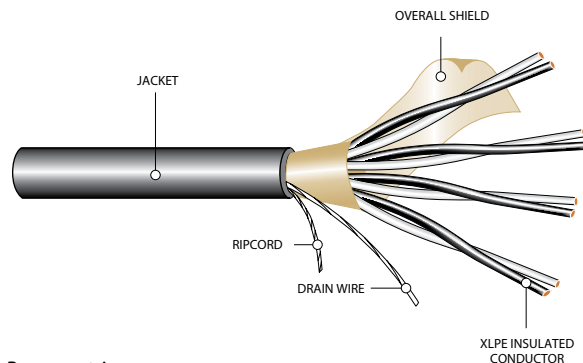

PAIRS

Part Number	No. of Pairs	Insulation Thickness (in.)	Approximate Diameter (in.)	Net Weight		Min. Bend Radius (in.)
				LB/MFT	KG/KM	
C3-1124-1601-11	1	0.025	0.316	48	71	3.7
C3-1224-1602-11	2	0.025	0.371	82	122	4.4
C3-1224-1604-11	4	0.025	0.572	149	221	6.8
C3-1224-1608-11	8	0.025	0.748	258	384	8.9
C3-1224-1612-11	12	0.025	0.876	388	577	10.5
C3-1224-1616-11	16	0.025	1.011	497	740	12.1
C3-1224-1624-11	24	0.025	1.201	706	1051	14.4
C3-1224-1636-11	36	0.025	1.399	1007	1498	16.7

TRIADS

Part Number	No. of Pairs	Insulation Thickness (in.)	Approximate Diameter (in.)	Net Weight		Min. Bend Radius (in.)
				LB/MFT	KG/KM	
C3-1134-1601-11	1	0.025	0.334	60	90	4.0
C3-1234-1602-11	2	0.025	0.559	126	187	6.7
C3-1234-1604-11	4	0.025	0.647	204	303	7.7
C3-1234-1608-11	8	0.025	0.880	393	584	10.5
C3-1234-1612-11	12	0.025	1.062	557	829	12.7
C3-1234-1616-11	16	0.025	1.178	712	1059	14.1
C3-1234-1624-11	24	0.025	1.415	1022	1521	16.9

Note: All dimensions are nominal and are subject to normal manufacturing tolerance. Specifications are subject to change without prior notice

* See page 20 for corresponding connectors.

XLPE Insulated Overall Shielded 18,16 & 14 AWG 600V

XLPE/PVC

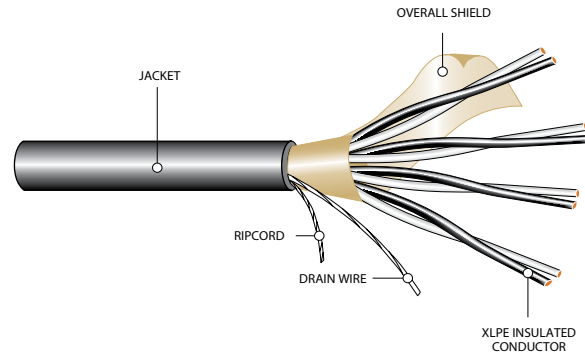

SPECIFICATIONS

- CSA C22.2 No. 230
- CSA C22.2 No. 239
- CSA C22.2 No. 38
- CSA FT4 rated (70,000 BTU Vertical Flame Test)

*refer to CE Code for details



CONSTRUCTION

- Conductor:** 7 strand tinned Class B concentric copper
- Insulation:** Flame retardant (FR) Cross-Linked Polyethylene (XLPE), Type RW90
- Overall Shield:** Overall aluminum/polyester tape shield with 7 strand drain wire
- Outer Jacket:** Low-temperature (-40°C), flame and sunlight resistant Polyvinyl Chloride (PVC), black
- Options:** Tinned copper braid shielded cables are available upon request
Polyvinyl Chloride (PVC) insulation
Other coloured outer jacket and constructions available upon request
600V
Individual and overall shields

PAIRS 16 AWG

Part Number	No. of Pairs	Insulation Thickness (in.)	Approximate Diameter (in.)	Net Weight		Min. Bend Radius (in.)
				LB/MFT	KG/KM	
C6-1124-1601-11	1	0.030	0.058	51	76	4.25
C6-1324-1602-11	2	0.030	0.396	87	130	4.75
C6-1324-1604-11	4	0.030	0.649	207	307	6
C6-1324-1608-11	8	0.030	0.871	341	508	7

PAIRS 14 AWG

C6-1124-1401-11	1	0.030	0.367	66	98	4.50
-----------------	---	-------	-------	----	----	------

TRIADS 18 AWG

Part Number	No. of Pairs	Insulation Thickness (in.)	Approximate Diameter (in.)	Net Weight		Min. Bend Radius (in.)
				LB/MFT	KG/KM	
C6-1134-1801-11	1	0.030	0.333	55	82	4

TRIADS 16 AWG

C6-1134-1601-11	1	0.030	0.356	69	102	4.50
C6-1334-1604-11	4	0.030	0.058	261	389	9
C6-1324-1612-11	12	0.030	0.058	537	799	12.75
C6-1324-1624-11	24	0.030	0.058	1012	1506	18

Note: All dimensions are nominal and are subject to normal manufacturing tolerance. Specifications are subject to change without prior notice

* See page 20 for corresponding connectors.

TC Connectors

Standard: Aluminum connectors

Options: Also available in nickel plated brass and stainless steel connectors

Locknuts: Aluminum connectors up to 1" hub size - steel locknut included
Aluminum connectors above 1" hub size - sold separately
Nickel plated connectors - all sizes sold separately
Stainless steel connectors - all sizes sold separately



	Hub Size (in.)	Part Number	Cable Jacket Diameter Overall OD (in.)	
		Aluminum	Min	Max
1	0.50	18-TC-050A028	0.13	0.28
1A	0.50	18-TC-050A055	0.26	0.55
2	0.75	18-TC-075A028	0.13	0.28
2A	0.75	18-TC-075A055	0.26	0.55
3	0.75	18-TC-075A079	0.47	0.79
3A	1.00	18-TC-100A079	0.47	0.79
4	1.00	18-TC-100A104	0.67	1.04
4A	1.25	18-TC-125A104	0.67	1.04
5	1.25	18-TC-125A127	0.92	1.27
5A	1.50	18-TC-150A127	0.92	1.27
6	1.50	18-TC-150A150	1.22	1.50
6A	2.00	18-TC-200A150	1.22	1.50
7	2.00	18-TC-200A174	1.40	1.74
7A	2.00	18-TC-200A197	1.63	1.97
8	2.50	18-TC-250A174	1.40	1.74
8A	2.50	18-TC-250A197	1.63	1.97
9	2.50	18-TC-250A220	1.86	2.20
9A	2.50	18-TC-250A244	2.13	2.44
10	3.00	18-TC-300A220	1.86	2.20
10A	3.00	18-TC-300A244	2.13	2.44
11	3.00	18-TC-300A268	2.40	2.68
11A	3.50	18-TC-350A268	2.40	2.68
12	3.50	18-TC-350A315	2.62	3.15
12A	4.00	18-TC-400A315	2.62	3.15

Note: All dimensions are nominal and are subject to normal manufacturing tolerance.
Specifications are subject to change without prior notice

EDITOR'S NOTE: Texcan has made every effort to ensure the accuracy of the information in this catalogue. Information contained herein neither constitutes endorsement of the product nor does Texcan make any claims or guarantees as to the accuracy or the completeness of the information. All information is subject to change without notice and suggestions made are not to be understood as recommendations to use any products in violation of any regulation or laws relating to any material or its intended use.

INDUSTRIES WE SERVE



AGRICULTURE



COMMERCIAL



COMMUNICATION



FORESTRY, PULP & PAPER



FOOD & BEVERAGE



HOSPITAL



INSTITUTION



LNG



MINING

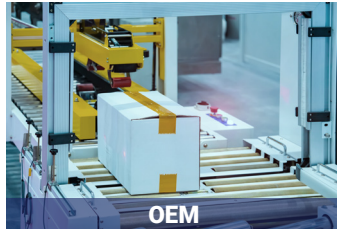

OEM



OIL & GAS



RENEWABLE ENERGY



RESIDENTIAL



UTILITIES



TRANSPORTATION



WATER TREATMENT PLANT

CABLE MANAGEMENT PROGRAM

CUSTOM TAGGING

We offer custom reel tags with project specific item identifiers and details, easing material management. Options include weather-proof, colour-coded stainless steel, printed RFID, or project specific templates.

SPECIALIZED PACKAGING

We can custom pack orders according to almost any specifications. Whether it's specified reel sizes, bug-free reels, or shrink wrapped pallets, we make sure it's packed right.

LOCAL AND INTERNATIONAL LOGISTICAL EXPERIENCE

Our team ensures your shipping standards, including custom packaging, are monitored, and met while keeping your project schedule in mind.

LAGGING

For long-distance transit, including export, bad weather, and rough terrain, we use wood covers or other suitable durable packaging to protect the reels.

When others can't, TEXCAN
WIRE & CABLE SPECIALISTS SINCE 1978

Building Wire

- AC90 Armoured Cables
- Fire Alarm Cables
- ACWU Armoured Cables
- NMD90/NMWU90 Cables
- Solid/Stranded Bare Copper
- RA90/Armoured Cables CU/AL
- SIMpull Solutions®
- RW90/RWU 90 CU / AL
- T90 CU/TW75/TWH/TWU
- LVT
- Grounding Cables

Control Cables

- Multi-conductor
 - Armoured/Unarmoured
- Portable Control Cables
- Shielded Control Cables
- Custom Bundling/Armouring

Communication

- Computer Cables
- Inside/Outside Plant Wires
- Telephone Cables
- Plenum Cables
- Direct Burial

Data Cables

- Category 5E, 6, 6A, 7 Rated Cables
- Co-Axial/Twin-Axial Cables
- Ethernet Cables
- Network Cables
- Patch Cords (Copper/Fiber Optic)
- Armoured Data Cables

Electronic Cables

- Armoured Cables
- Audio/Visual Cables
- Broadcast Cables
- Low Capacitance Wires
- Plenum Wires
- Precision Video Wires
- Industrial Automation Cables
- Belden® Classics & NewGen

Fiber Optic Cables

- SM/MM
- Loose Tube, Tight Buffer
- Indoor/Outdoor/Riser/ADSS
- Armoured/Non-Armoured
- Hybrid Fiber
- Specialty XPRLTM/RLTM

Instrumentation

- Armoured/Unarmoured
 - Interlocked Steel/Aluminum
- Multiconductor/Pairs/Triads
- Shielded/Unshielded
- Thermocouple Wires

Marine Cables

- Boat Cables
- Shipboard Cables
- Offshore Rig/Marine Cables

Mining Cables

- Blasting Wires
- Mine Power Feeder Cables
- Portable Power Cables
 - Type W, G, GGC, SHDGC (2KV to 35 KV)
- Trailing Cables
- Cable Assemblies
- Vertical Riser Cables
- Reeling Cables
- DLO (Diesel Locomotive Cables)

Portable Cords

- High Temperature Cables
- Ultraflex™ Low Temperature Cords
- Ultraflex™ Extension Cords
- Retractable Cords
- Type: SJQOW, SOOW, SJTOW, STOW
- Welding Cables
- Stage Lighting
- Landscape Lighting
- Multiconductor

Power Cables

- ACSR/AAC Linewire
- High Voltage Power Cables
- TECK 90 HL Cables (600V-35KV)
- Overhead Service (NS75 / NS90)
 - Duplex, Triplex, Quadruplex
- Underground Service
 - USE1, USEB
- Variable Frequency Drive (VFD) Cables

- Tray Cables
 - Power and Control
- Underground Distribution
- Airport Lighting Cables
- Utility Hydro Cables
- Airguard™

Specialty Products & Cords

- 2HR Fire Rated VITALink® Fire Resistant
- Traffic Signal Cables CLMTO/IMSA
- Coil Lead Wires
- European Cables (CE & VDE approved)
- Teflon® Insulated Wires
- SIS Switchboard Wires
- TEW Equipment Wires
- Small Diameter Flexible Control (SDN)
- Low Smoke Zero Halogen Cables
- TR64
- Extra Flexible Portable Cables
- Parallel Conductor Cords
- Trailer Cables
- Battery Cables
- Pendant Cables/Festoon
- Mil Spec Hookup Wires
- Tracer Wires
- Automotive Cables

Additional Services & Accessories

Tools & Equipment

- Material Handling & Storage
- Cable Pulling & Fishing

Power Management

- Extension Cords
- Temporary Power Distribution

Lighting

- Area Lights
- String Lights
- Temporary Overhead Lighting

Connectors

- Armoured Cable Connectors
- Explosion-proof Connectors
- Strain Reliefs Metal & Nylon
- Tray Cable Connectors

Accessories

- Heat Trace cables & accessories
- Hardware, Lugs, Cable Ties
- 3M Accessories
 - Cold Shrink Splices and Terminations
 - Heat Shrink Splices and Terminations
- 3M Accessories
- High Voltage Termination Kit
- Split Loom

Value Added Services

- Custom-Built Cables
- Cable Management Program
- Specialized Technical Assistance
- 24/7 Emergency Shipping Service
- International Export Services
- Custom Cables/Printing/Cutting
- Paralleling/Lagging/Tagging
- Bundling/Armouring
- Bar Coding and Inventory Tracking
- State-of-the-Art Distribution Centre

Visit our website at Texcan.com and social media [@TexcanCanada](https://www.facebook.com/TexcanCanada)

VANCOUVER

1-800-665-1025
10449 120th St. Surrey, BC

MAJOR PROJECTS GROUP

1-888-818-9473
10449 120th St. Surrey, BC

EDMONTON

1-800-252-7545
11330 189 St. NW. Edmonton, AB

CALGARY

1-855-717-3900
#105-10710 25th St. NE. Calgary, AB

SASKATOON

1-855-385-3800
3403 Faithfull Ave. Saskatoon, SK

WINNIPEG

1-800-665-2491
25 Meridian Dr. Winnipeg, MB