

HemoSphere advanced monitor setup

1. Securely position the HemoSphere advanced monitor or mount on a compatible stand.
2. Open the battery door on the lower right panel of the HemoSphere advanced monitor and insert the battery.
3. Connect the power cord to the rear panel of the monitor and plug into a hospital grade outlet. Note: after inserting the battery for the first time, the battery must be fully charged and conditioned. Refer to operator's manual for additional information.
4. Insert desired hemodynamic technology module and/or cable. Refer to module or cable instructions for proper insertion/connection procedures.
5. Press power button on the front of the monitor. Note: upon initial startup the display language can be selected which affects the time/date format and units of measurement.

Follow instructions contained in the HemoSphere advanced monitoring platform operator's manual for desired hemodynamic technology module or cable monitoring.



Back of the monitor

1. Main power cord connection
2. HDMI port
3. Ethernet port
4. USB port
5. COM1 serial port connector (RS-232)
6. Analog input 1
7. Analog input 2
8. ECG input
9. Pressure output
10. Equipotential terminal stud

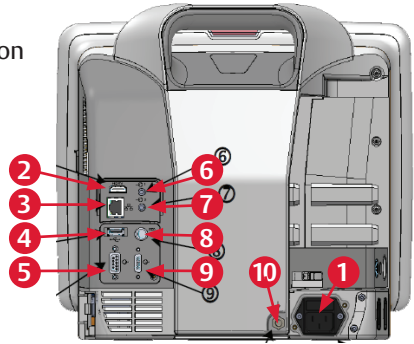

Monitor right panel

1. USB port
2. Battery door



Monitor left panel

1. L-Tech expansion module slot
2. Expansion module slots (2)
3. Smart cable ports (2)



HemoSphere advanced monitor screen features

Navigation bar

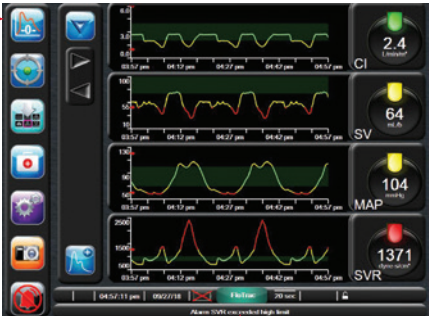

Parameter globe

Information bar







Status Bar

Main window

Swan-Ganz Module

Setup guide

HemoSphere advanced monitor screen features

- Start/stop monitoring →  → Start CO monitoring
 → Stop CO monitoring
- Monitor screen selection →  → Choose between six visual clinical support screens, the selected screen will appear in the main window
- Clinical actions →  →
 - Oximetry calibration
 - Patient CCO cable test
 - Derived value calculator
 - iCO
 - Event review
- Settings →  →
 - Patient data
 - Advanced setup
 - Demo mode
 - Help
 - Monitor settings
 - Export data
 - Engineering
- Snapshot →  → Captures an image of the screen at the current time
- Silence audible alarm →  → This icon silences all alarms for two minutes

Parameter globes



1. To change a displayed parameter, touch outside the globe you want to change.
2. The selected parameter appears highlighted. The other parameters being displayed are outlined. Available parameters appear without highlights.
3. Touch the replacement parameter to update.

HemoSphere advanced monitor information bar



HemoSphere Swan-Ganz module setup

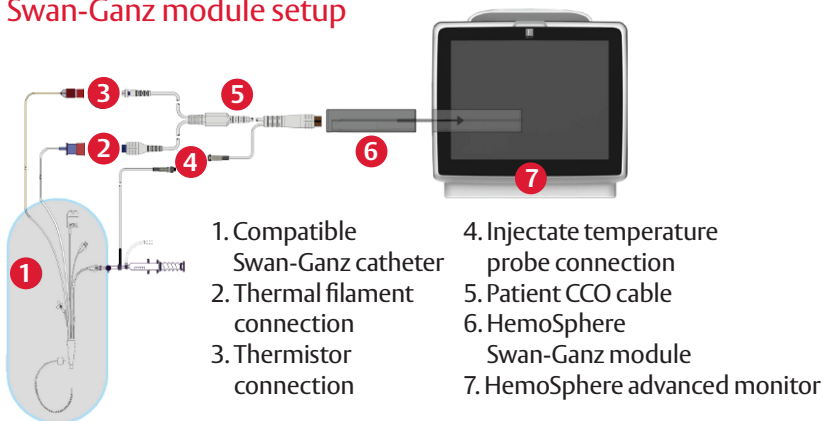







HemoSphere Swan-Ganz module setup

1. Insert the HemoSphere Swan-Ganz module into a standard module slot on the left panel of the HemoSphere advanced monitor. The module will click in place when properly engaged.
2. Turn on monitor power switch and follow steps for entering patient data.
3. Plug the patient CCO cable into the module using the connection guide arrows for proper orientation. For CCO cable test, refer to ops manual.
4. Connect the compatible Swan-Ganz catheter to the patient CCO cable.
5. Refer to the HemoSphere advanced monitor operator's manual for catheter connection guidelines and monitoring procedures.

FloTrac Sensor

Setup guide

HemoSphere advanced monitor screen features

Zero & Waveform		Zero FloTrac sensor
PGDT tracking		Time-in-Target indicator
Screen selection		Choose between eight visual clinical support screens, the selected screen will appear in the main window
Clinical actions		<ul style="list-style-type: none"> • Oximetry calibration • Event review • Derived value calculator • Zero FloTrac sensor • Enter CVP
Settings		<ul style="list-style-type: none"> • Patient data • Advanced setup • Demo mode • Help • Monitor settings • Export data • Engineering
Snapshot		Captures an image of the screen at the current time
Silence audible alarm		This icon silences all alarms for two minutes

Zeroing Screen



To zero with the stopcock off to the patient and open to air:

1. Hold down zero button on the pressure cable for three seconds to pull up zero screen
2. Repeat step one to complete zeroing OR

zeroing can be completed by selecting the 'Quick Zero' button to pull up the zero screen, then select 'zero'

HemoSphere advanced monitor information bar

							
Wi-Fi status	HIS status	Time	Date	Battery	Monitoring mode	Averaging time	Lock screen

FloTrac Sensor Setup

1. Open the FloTrac sensor packaging and inspect contents. Replace all caps with non-vented caps and ensure that all connections are tight.
2. Mount the FloTrac sensor on an IV pole using the appropriate holder.
3. **To de-air and prime I.V. bag and FloTrac system:** Insert I.V. bag into the **Pressure Bag** and hang on I.V. pole (**do not inflate**).
4. With gravity only (**no pressure in Pressure Bag**), flush FloTrac sensor holding pressure tubing in upright position as the column of fluid raises through the tubing, pushing air out of the pressure tubing until the fluid reaches the end of the tubing.
5. Pressurize the **Pressure Bag** until it reaches 300 mmHg.
6. Fast-flush the FloTrac sensor and tap on tubing and stopcocks to remove any residual bubbles.
7. Connect tubing to arterial catheter, then aspirate and flush system to assure no residual bubbles remain.
8. Level the FloTrac sensor to the phlebostatic axis. **Note: It is important to keep the FloTrac sensor level to the phlebostatic axis at all times to ensure accuracy of cardiac output.**

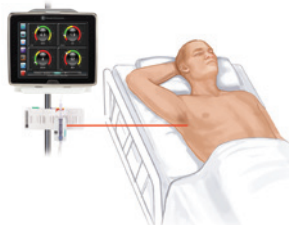

Acumen IQ Sensor

Setup guide

HemoSphere advanced monitor screen features

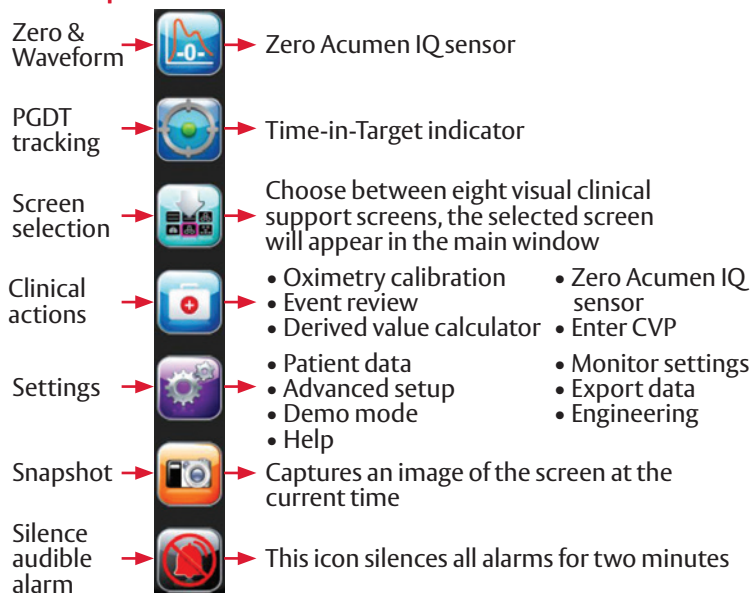

Parameter globes



1. To change a displayed parameter, touch outside the globe you want to change.
2. The selected parameter appears highlighted. The other parameters being displayed are outlined. Available parameters appear without highlights.
3. Touch the replacement parameter to update.

HemoSphere advanced monitor information bar



Acumen IQ Sensor Setup

1. Open the Acumen IQ sensor packaging and inspect contents. Replace all caps with non-vented caps and ensure that all connections are tight.
2. Mount the Acumen IQ sensor on an IV pole using the appropriate holder.
3. **To de-air and prime I.V. bag and Acumen IQ system:** Insert I.V. bag into the **Pressure Bag** and hang on I.V. pole (**do not inflate**).
4. With gravity only (**no pressure in Pressure Bag**), flush Acumen IQ sensor holding pressure tubing in upright position as the column of fluid raises through the tubing, pushing air out of the pressure tubing until the fluid reaches the end of the tubing.
5. Pressurize the **Pressure Bag** until it reaches 300 mmHg.
6. Fast-flush the Acumen IQ sensor and tap on tubing and stopcocks to remove any residual bubbles.
7. Connect tubing to arterial catheter, then aspirate and flush system to assure no residual bubbles remain.
8. Level the Acumen IQ sensor to the phlebostatic axis. **Note: It is important to keep the Acumen IQ sensor level to the phlebostatic axis at all times to ensure accuracy of cardiac output.**

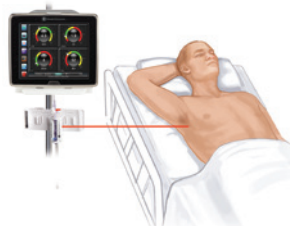

For professional use. See instructions for use for full prescribing information, including indications, contraindications, warnings, precautions, and adverse events.

Edwards Lifesciences devices placed on the European market meeting the essential requirements referred to in Article 3 of the Medical Device Directive 93/42/EEC bear the CE marking of conformity.

Edwards, Edwards Lifesciences, the stylized E logo, Acumen, Acumen IQ, FloTrac, HemoSphere, Swan, Swan-Ganz, and Time-in-Target are trademarks of Edwards Lifesciences Corporation or its affiliates. All other trademarks are the property of their respective owners.

© 2019 Edwards Lifesciences Corporation. All rights reserved. ENP533/02-19/CC

Edwards Lifesciences

Route de l'Etraz 70, 1260 Nyon, Switzerland • edwards.com



Edwards