

THIS DOCUMENT IS FOR REFERENCE ONLY AND IS PROPRIETARY INFORMATION BELONGING TO INTERNATIONAL FILTER PRODUCTS UNAUTHORIZED COPIES OR USE FOR OTHER PURPOSES STRICTLY PROHIBITED.

REVISIONS				
ZONE	REV	DESCRIPTION	DATE	APPROVED
	-	SALES DRAWING	10/28/2022	YA ZANKI

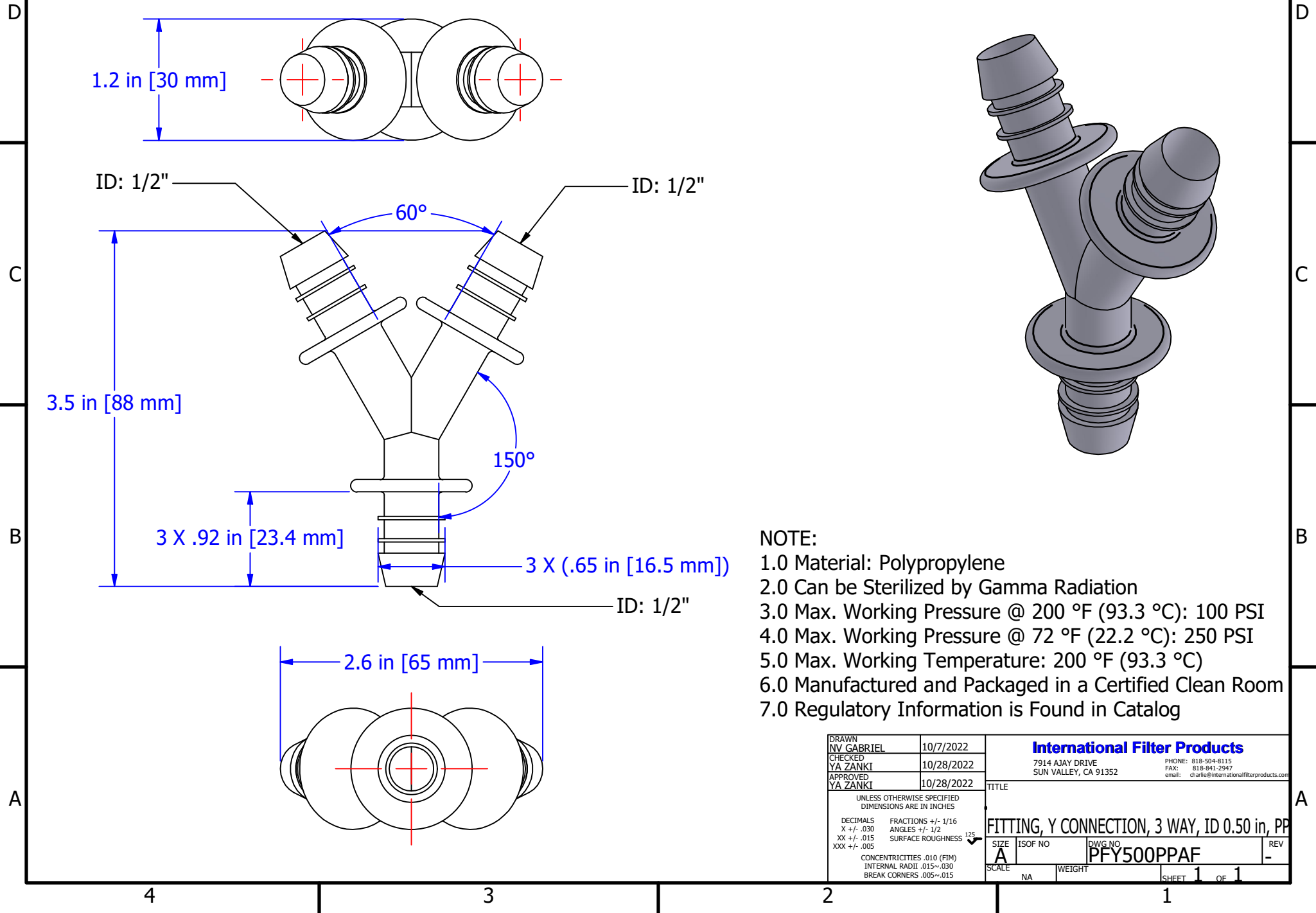

- NOTE:**
- 1.0 Material: Polypropylene
  - 2.0 Can be Sterilized by Gamma Radiation
  - 3.0 Max. Working Pressure @ 200 °F (93.3 °C): 100 PSI
  - 4.0 Max. Working Pressure @ 72 °F (22.2 °C): 250 PSI
  - 5.0 Max. Working Temperature: 200 °F (93.3 °C)
  - 6.0 Manufactured and Packaged in a Certified Clean Room
  - 7.0 Regulatory Information is Found in Catalog

DRAWN NV GABRIEL 10/7/2022 CHECKED YA ZANKI 10/28/2022 APPROVED YA ZANKI 10/28/2022	<b>International Filter Products</b> 7914 AJAY DRIVE SUN VALLEY, CA 91352 PHONE: 818-504-8115 FAX: 818-841-2947 email: charlie@internationalfilterproducts.com	
UNLESS OTHERWISE SPECIFIED DIMENSIONS ARE IN INCHES DECIMALS    FRACTIONS +/- 1/16 X +/- .030    ANGLES +/- 1/2 XX +/- .015    SURFACE ROUGHNESS 125 XXX +/- .005 CONCENTRICITIES .010 (FIM) INTERNAL RADII .015~.030 BREAK CORNERS .005~.015		TITLE <b>FITTING, Y CONNECTION, 3 WAY, ID 0.50 in, PP</b>
SIZE <b>A</b>	ISOF NO DWG NO <b>PFY500PPAF</b>	REV -
SCALE NA	WEIGHT	SHEET <b>1</b> OF <b>1</b>