

## KNOWLEDGE BASE

# Release notes IDEA StatiCa 22.1

The list of coming features and improvements is long enough to make the 22.1 not only an upgrade but a full new version of IDEA StatiCa, better than any other before.

## News for Steel

What happened to all that user feedback about Fire design and Tying forces? We listened, we implemented. There are two brand new analysis types in the IDEA StatiCa Connection application.

The first one looks into situations where the structural engineer has to prevent the possibility of progressive collapse of the structure (caused by gas blasts, vehicle collisions, or similar incidents). The structure has to be able to resist the tension forces from membrane floor actions. For these design states, we have developed the **Horizontal tying analysis**.

Another extraordinary but even more often analyzed design situation is the fire. The main bearing structures of all new buildings have to provide at least some fire resistance. For steel structures especially, this is often the crucial resistance because the performance of steel decreases dramatically with higher temperatures.

From version 22.1, the designers can analyze steel connections and also the whole members connected together for stated temperatures, thanks to **Fire design** analysis present both in the IDEA StatiCa Connection and Member applications.

Besides these, we have prepared many other enhancements, which will help in the everyday practice of our users.

### Improvements for steel connection design and member analysis:

- **Horizontal tying resistance**

- [Fire design of steel connections](#)
- [Plate and weld clash check](#)
- [Connection Browser: Properties, parameters, and filtering](#)
- [Contact can be set alongside weld](#)
- [Operation Cut of plate redesigned](#)
- [Timber connections: show angle to grains](#) (since 22.0.1 patch)
- [Dialog redesign](#) (since 22.0.3 patch)

## Minor improvements

- EN - unify some of the subscripts in the report (since the 22.0.1 patch)
- Remove NVOL from contact, weld, and bolt grid operations (since the 22.0.2 patch)
- Set the length of the condensed element in IOM (since the 22.0.3 patch)
- AISC weld symbols – leg size  $L_s$  changed to  $w$ , throat thickness  $T_h$  changed to  $t_w$  (in line with AISC 360)
- Imperial units - add rotational stiffness units
- Gusset plate - notched member
- Member cut - Bounding box refactoring to allow cutting of a plate with more than 4 edges

## News for Concrete and Prestressing

Do you design reinforced concrete high-rise or industrial buildings and need to solve their fire resistance? A new functionality, advanced thermal analysis, helps you with the fire resistance check of beams and columns subjected to the fire effects. Due to IDEA StatiCa 22.1, you can ensure an optimized and cost-effective structural design that provides the required fire safety.

Is it your daily job to design and assess precast prestressed beams or walls with openings, dapped end beams, or even beams with haunches? Do you struggle with how to calculate the crack width or deflection of the structure? Now, in IDEA StatiCa Detail, you can perform along with ULS **also SLS assessments of prestressed concrete discontinuity regions**. Code-checks as the stress limitation, crack width, and deflection will no longer be pain or just an estimate but will be verified using Compatible Stress Field Method (CSFM).

The improvements in Concrete and Prestressing include:

- [Thermal analysis of concrete structures](#)
- [SLS checks of prestressed concrete discontinuity regions](#)
- [Detail: Mesh refinement around openings and above supports](#)
- [Nonlinear analysis of tapered members](#)
- [GMNIA solver extended to shear and torsion effects](#)

## News for BIM links

In version IDEA StatiCa 22.1, we focused on polishing the way how the information is coming to us from 3rd party applications. Until now, every link was special in some way, and seamless workflow and maintenance was a tricky task. Therefore our developers brought a new solution for translating different structural languages into the IDEA StatiCa

IOM language and developed a new **BimApi interface**.

This new approach provides a more straightforward integration of IDEA StatiCa plugins. Integrations not only for actively supported 3rd party apps but BimApi mainly eases the job for other developers and companies willing to connect and use the advantages of analyses in IDEA StatiCa applications.

Besides this major improvement, a whole package of useful enhancements for practical use of the Checkbot app is brought in version IDEA StatiCa 22.1:

- [Checkbot improvements in 3D Scene](#)
- [New BimApi workflow](#)

If you want to check the compatibility with your particular application, just take a look at our list of actively [supported versions](#).

## Licensing & All applications

Other examples of careful listening to our customers are introduced in our online features, which use data analysis and online communication.

- [License usage analytics in the User Portal](#)
- [All applications: Search box](#)

## Solved incidents

See the current [list of solved incidents](#) reported by our customers.

# News for Steel

## Horizontal tying resistance

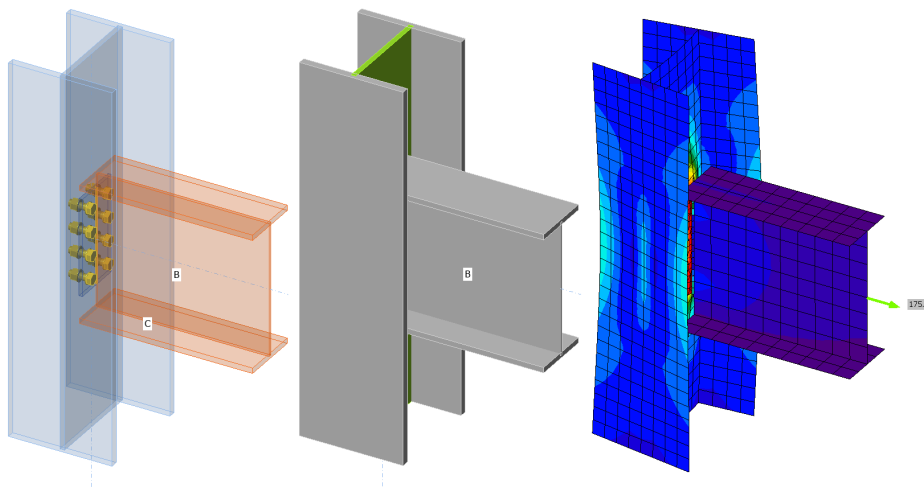

Several options are possible but the most used is the prescriptive approach: horizontal tying resistance. Connections must be designed to transform the tensile forces that are generated by second-order effects when a column is removed and the floor acts as a membrane.

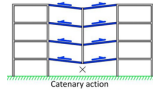

This analysis type is valid only for EN. Only one member is analyzed, all others are restrained (similar to the **stiffness analysis** type).

The Model type of the analyzed member is automatically changed to N-Vy-Vz. Only one load component – N – can be set; all others are set to zero.

Available in the **Enhanced** edition of **IDEA StatiCa Steel**.

## Fire design of steel connections

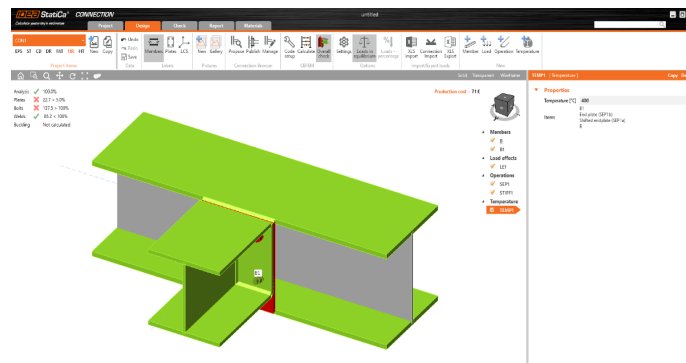

Fire design is necessary for nearly every structure. Most often, designers use simple or tabulated methods and apply fire protection. However, performance fire design may save a lot of resources, time and protect the environment (fire protection is quite demanding).

Currently, you must calculate the temperature of the steel elements elsewhere and then set the temperatures for the steel plates. The temperature of welds and bolts is assumed as the highest of the connected parts.

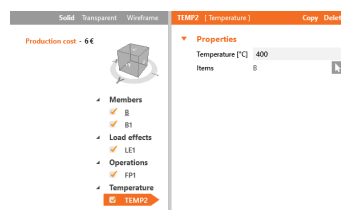

Material degradation is selected in Shared settings according to design codes and load-deformation curves of all elements are modified based on the set temperature.

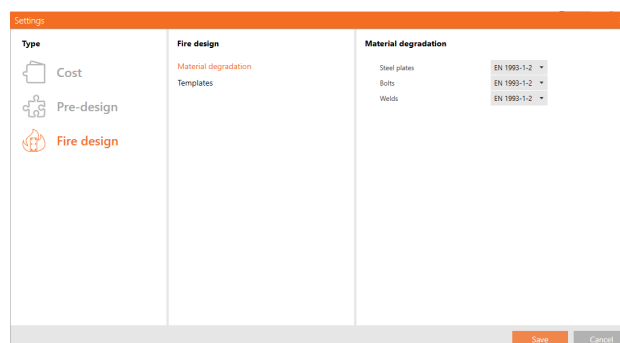



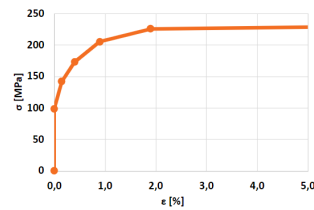

Available in the **Enhanced** edition of **IDEA StatiCa Steel**

## Plate and weld clash check

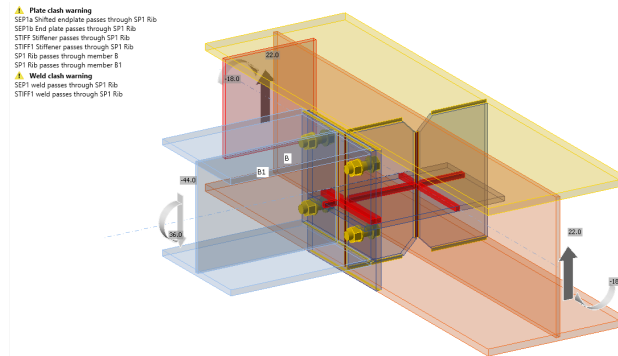

Plates, parts of the model can be positioned in a way that collides with the other plates and members.

The check is set to active by default in Code setup. If this is not desired, the user can be able to deactivate the check.

The presented warning will not affect the analysis or check. It's a user's decision, how to react or neglect the warning.

### Visual location of the clash

A weld clash check can be visualized to help users locate the issue in the model. The clash area will be visualized as a red-colored area in the Transparent model view (similar to contact between two plates).

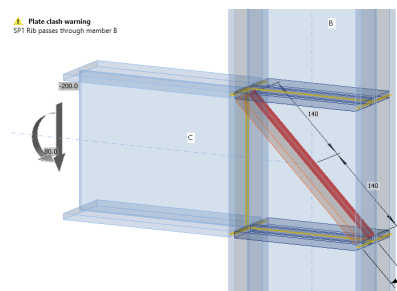

### Tolerance

The clash is detected with a tolerance value, which is set to 2mm. Currently, the user cannot change the default value.

Available in both **Expert** and **Enhanced** editions of **IDEA StatiCa Steel**

## Connection Browser: Properties, parameters, and filtering

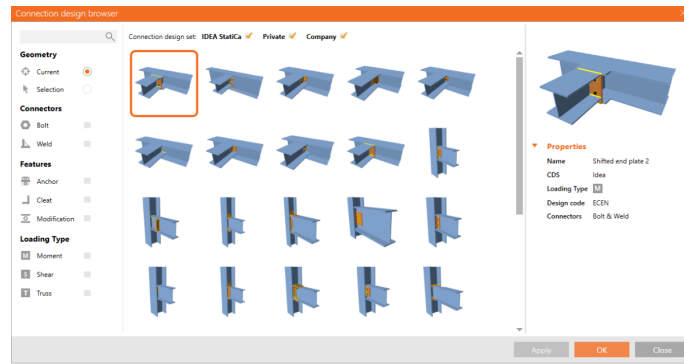

We are continuously improving the Connection Browser tool and fulfilling our promise to build an AI automated design based on machine learning technology. Properties of the connection template are enhanced with more Parameters added.

## Parameters available within the particular features

### Propose:

- Connection Design Set (set of joints - IDEA, Private, Company)
- Loading type (Moment, Shear, Truss, one, none, or more can be selected)
- Design code

### Publish:

- Loading type
- Connection Design Set

### Manage:

- Connection Design Set
- Loading type (editable in Edit mode)
- Connectors
- Created

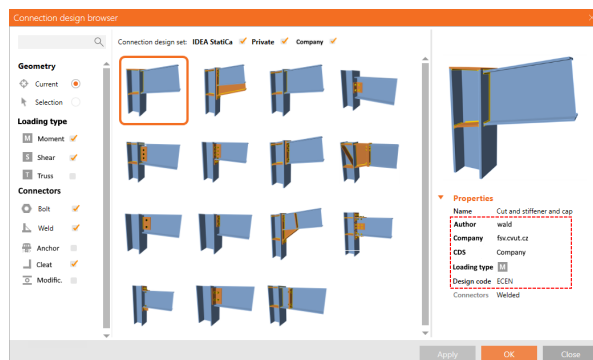

## Filtering

For better orientation, filtering, and selection of the most relevant designs, we brought a whole bunch of different Connection Design Items (CDI) into the Propose dialogue.

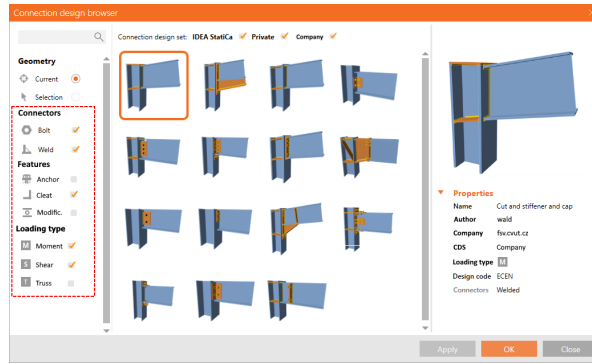

## Types of possible CDIs for filtering:

- Connectors
  - Bolt
  - Weld
- Features
  - Anchor
  - Cleat
  - Modification
- Loading Type
  - Moment
  - Shear
  - Truss

Available in both **Expert** and **Enhanced** editions of **IDEA StatiCa Steel**.

## Contact can be set alongside weld

Check of welds for extreme load effect														
Status	Item	Edge	Th [mm]	L [mm]	Loads	$\sigma_{w,Ed}$ [MPa]	$\sigma_{PI}$ [%]	$\sigma_{\perp}$ [MPa]	$\tau_{II}$ [MPa]	$\tau_{\perp}$ [MPa]	UH [%]	UH [%]		
>	+	BP1	B-bf1	1	4.0	300	LE1	233.3	0.0	70.0	-89.4	108.5	58.2	24
	+	BP1	B-bf1	1	4.0	300	LE1	384.4	0.0	162.7	158.0	-124.3	88.2	25
	+	BP1	B-bf1	1	4.0	300	LE1	200.3	0.0	-37.1	-105.7	-41.7	46.0	35
	+	BP1	B-bf1	1	4.0	300	LE1	185.3	0.0	-24.3	104.2	19.7	42.5	19
	+	BP1	B-w	1	4.0	276	LE1	196.8	0.0	93.5	-14.4	98.9	45.2	8.7
	+	BP1	B-w	1	4.0	276	LE1	191.3	0.0	99.0	13.2	-93.6	43.9	8.5
	+	BP1	B-w	1	4.0	276	LE1	-	-	-	-	-	0.0	0.0
	+	BP1	B-bf1	1	4.0	300	LE1	-	-	-	-	-	0.0	0.0
	+	BP1	B-bf1	1	4.0	300	LE1	-	-	-	-	-	0.0	0.0

Since the version 22.1 the weld and contact operations can be combined.

A weld is very stiff and it has to be loaded to yield a bit and allow the contact to take effect. That means there is significant stress even for welds in compression with contact. However, that does not decrease the resistance of such a weld in shear.

A fillet weld with contact has a new symbol: a triangle with an arrow (check and report). A symbol explanation was also added to the report.

Users should be aware that welds are usually checked in compression. If a compressive load transmission is allowed by contact, the surfaces must be precisely cut and there must be no gap.

When the member is cut precisely, it is possible to assume the transfer of compressive forces by contact and welds transfer only tensile and shear forces. This is commonly used especially for column bases, mostly in regions of Western Europe.

Remember – it is the user's responsibility to ensure no gap and the precise cut of the member.

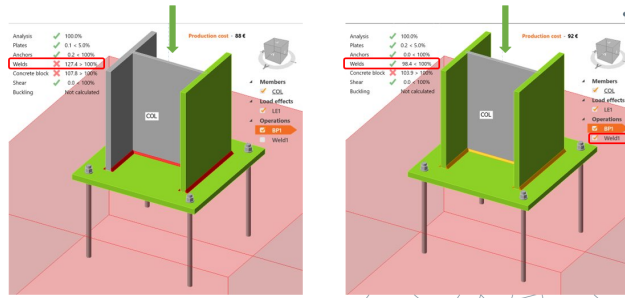

Available in both **Expert** and **Enhanced** editions of **IDEA StatiCa Steel**

## Operation Cut of plate redesigned

Cut operation is one of the most used modeling techniques in IDEA StatiCa Connection. It can also deal with the intersection of plates.

The operation Cut can also handle the intersection of plates with openings correctly.

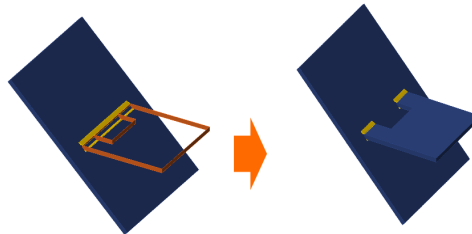

Cut by Work plane is also possible.

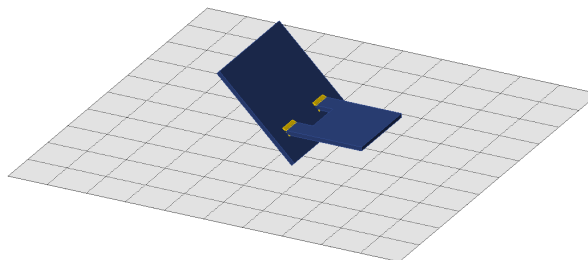

For Cut by "Plate" or "Work plane" + is for the direction of the plate, - is for the other way around.

For Cut by "Member" + means that a larger or equal part of the cut plate (modified item) will remain, - the smaller part will remain.

Available in both **Expert** and **Enhanced** editions of **IDEA StatiCa Steel**.

## Timber connections: show angle to grains (since 22.0.1 patch)

Since the patch 22.0.1 it has been possible to see the resultant grain angle for the bolt check.

Angle to the grain (in particular parallel and perpendicular) is used in timber checks of nails, screws, and bolts. Timber is orthotropic, and the angle to the grain is extremely important. This helps users with their subsequent checks of timber connections.

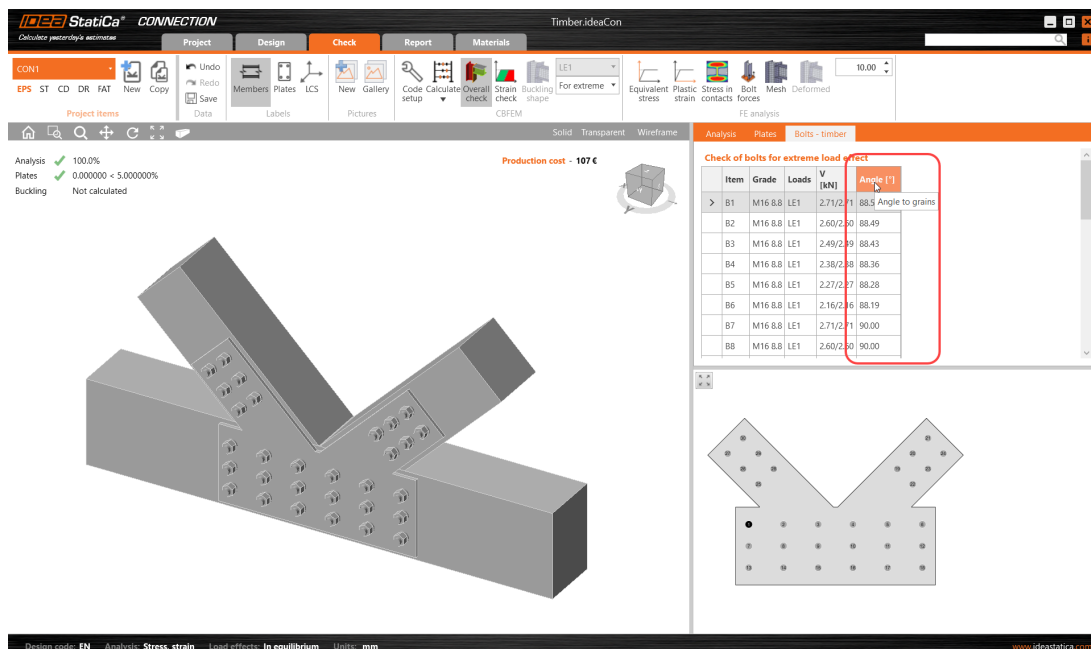

## Dialog redesign (since 22.0.3 patch)

We are constantly improving the interface of IDEA StatiCa tools and making them more user-friendly. In version IDEA StatiCa 22.1 we have redesigned the dialogues with the model settings.

Besides the visual changes and unified look, we brought a standardized behavior of the windows, such as close by Esc and confirm by the Enter button.

Some other dialogs also get more advanced features.

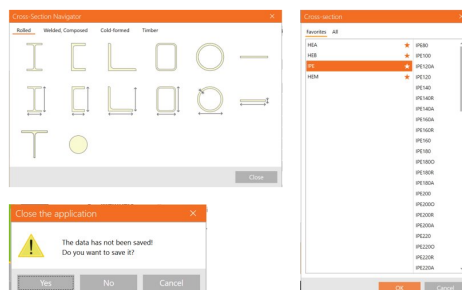

# Download & try all new features of IDEA StatiCa 22.1

DOWNLOAD IDEA STATICA 22.1 →

## News for Concrete and Prestressing

### Thermal analysis of concrete structures

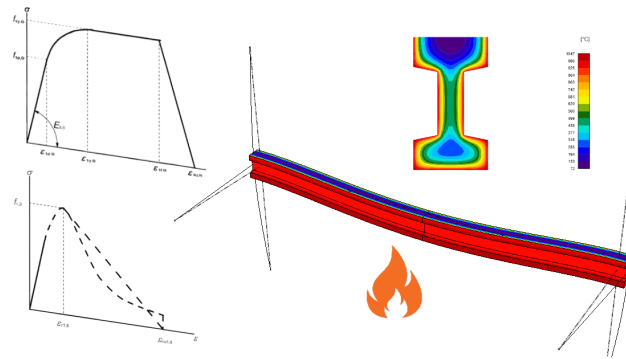

A fire resistance check of buildings is a necessity nowadays. But what to do when the tabular data or other simplifying methods are not enough? Looking for a response of a structural member subjected to thermal loads? Take advantage of the advanced thermal analysis in IDEA StatiCa Member.

What methods are used when assessing the structural fire performance for beams and columns? You can choose among several design procedures according to EN 1992-1-2:

- **Tabulated data** - available in application IDEA StatiCa RCS since version 10.1
- Simplified calculation methods - 500°C isotherm method, Zone method
- Advanced calculation methods

This time we skipped the other simplified methods and we were determined to develop the most advanced calculation method you can use. And that is the **thermal analysis** (TA). Even though you find the most advanced analysis in IDEA StatiCa apps the workflows are kept as easy as possible. So, designing and checking of concrete structures for fire resistance is very easy again.

### Fire performance of reinforced concrete beams and columns in a few steps

This time we skipped the other simplified methods and we were determined to develop the most advanced calculation method you can use. And that is the **thermal analysis** (TA). Even though you find the most advanced analysis in IDEA StatiCa apps the workflows are kept as easy as possible. So, designing and checking of concrete structures for fire resistance is very easy again.

### Fire performance of reinforced concrete beams and columns in a few steps

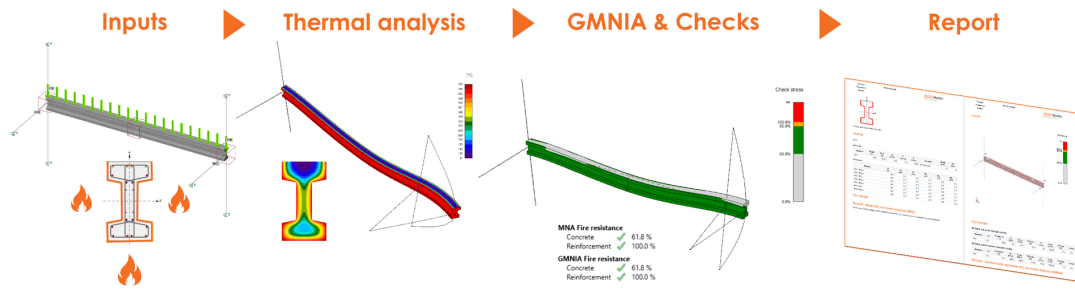

## Geometry

Analyzed member(s) can be beams, columns, or frames of any shape of cross-sections.



## Fire inputs and loads

If you want to run a thermal analysis you need to set the fire exposure data first. Fire resistance class, concrete moisture, member temperature, and what parts, and edges of the analyzed member are exposed to the fire.

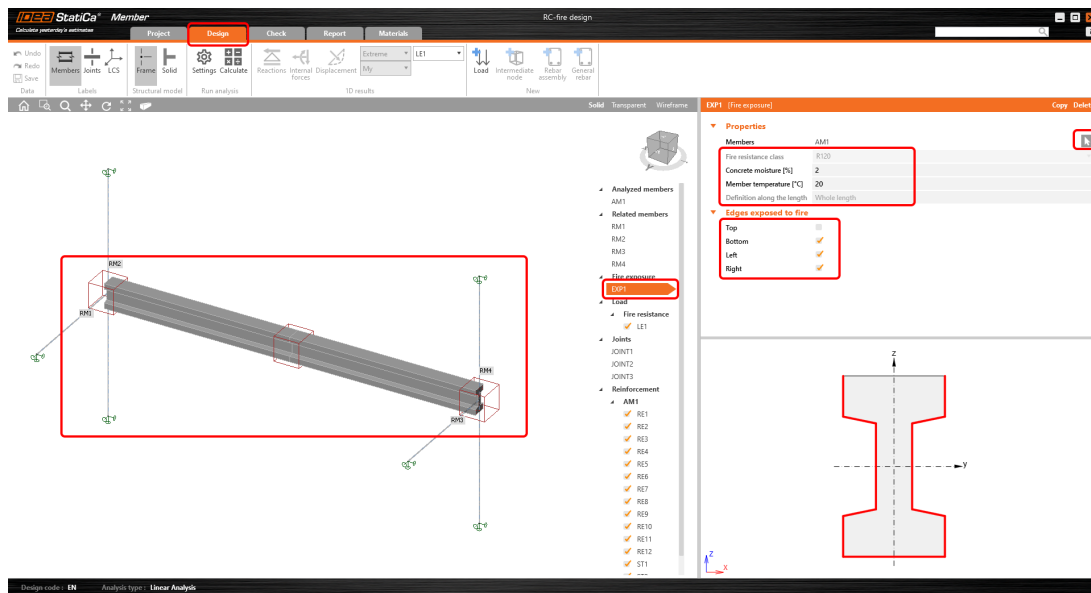

## Thermal analysis

Thermal analysis is based on performing a non-stationary heat transfer over a cross-section (temperature varies in time). Regarding the material properties of concrete and reinforcement and temperature range, this method is non-linear. The initial condition is the temperature of the environment in time according to Eurocode 1991-1-2.

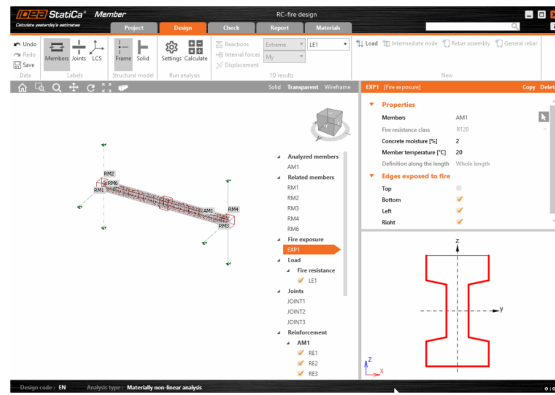

Similarly, like **Geometrically and materially non-linear analysis (GMNA)**, implemented in IDEA StatiCa Member, the analyzed member is divided into sections that are meshed to finite elements within the heat transfer is calculated.

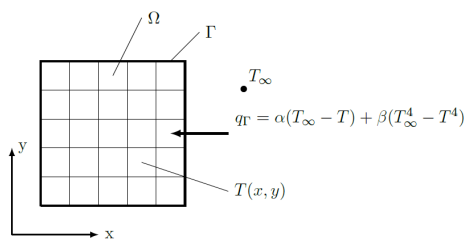

The output of the thermal analysis is a temperature field within the cross-section at the time indicated by the fire resistance class (R 60, e.g.). Such a distribution of the temperature within the cross-section is used to determine the material properties of concrete and reinforcement and thermal strain. The material degradation respects tables stated in the Eurocode EN 1992-1-2 or can be defined by the user and saved in the templates.

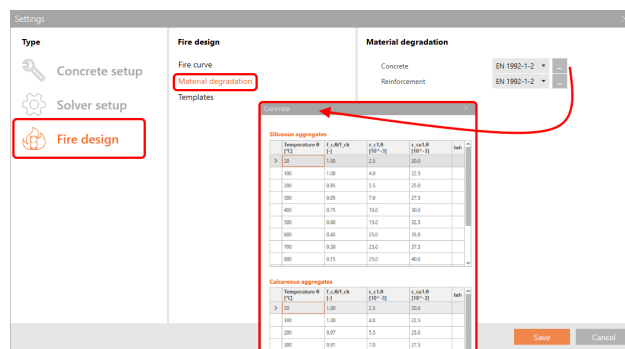

You can look at the distribution of the temperature in overall or detailed views.



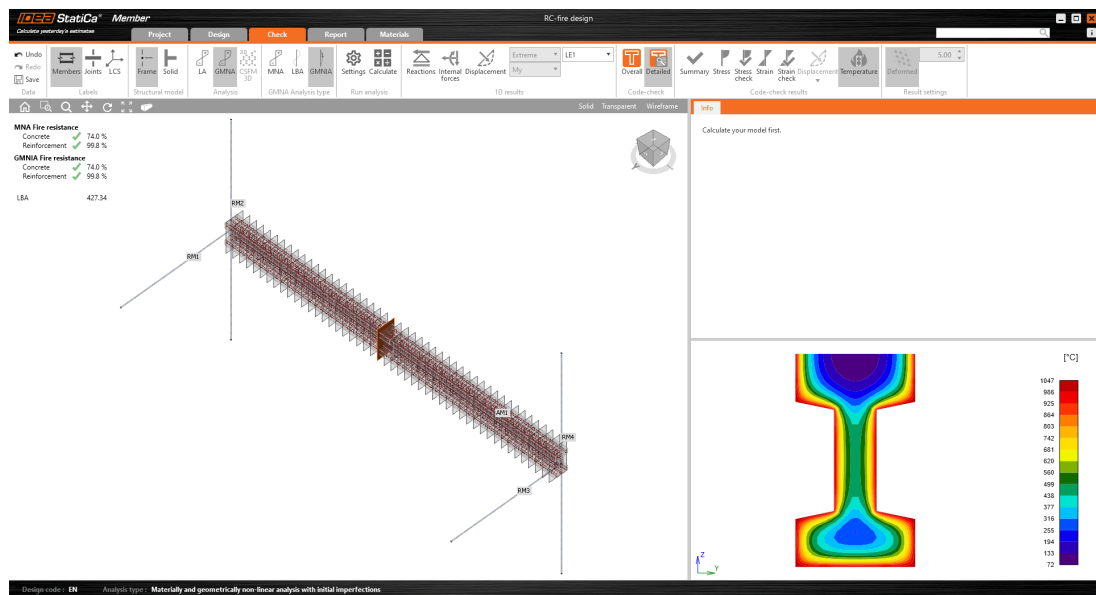
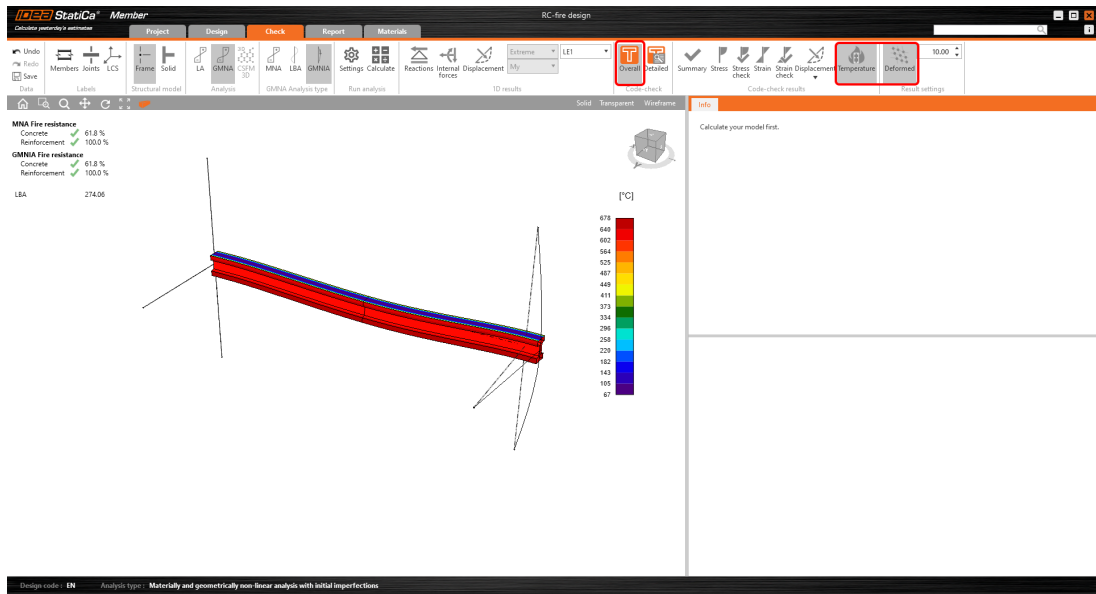

## Geometrically and materially non-linear analysis

After performing the thermal analysis (TA), geometrically and materially non-linear analysis (GMNA) is automatically started using the outputs of thermal analysis as the initial state of the analyzed member. The results of the GMNA are stresses and strains which are compared to the limit (degraded) values.

Stress values in concrete in compression (concrete in tension is excluded).

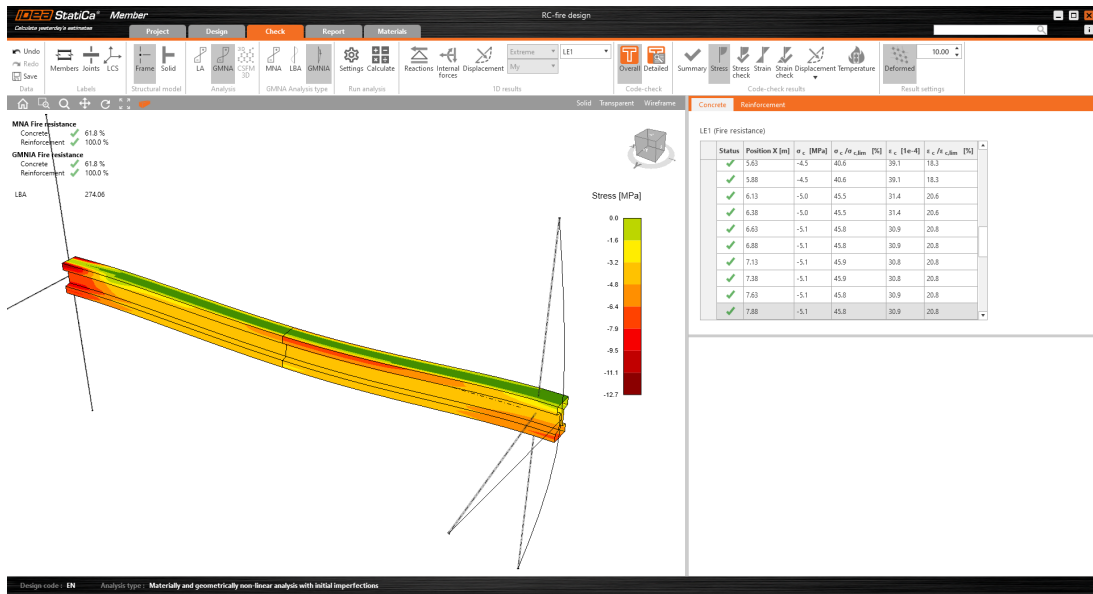

Stress values in reinforcement

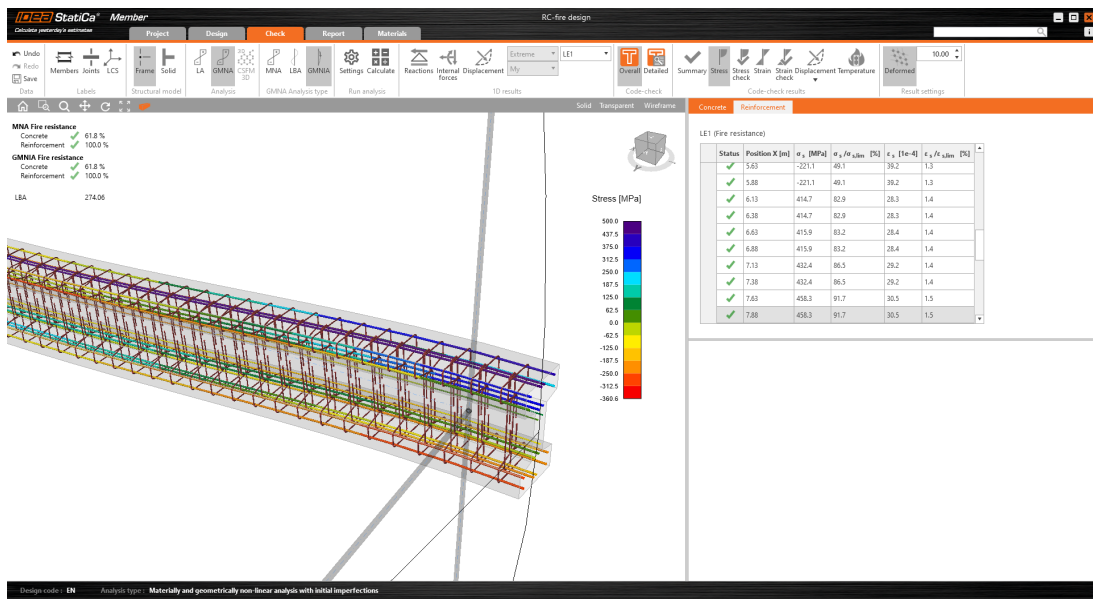

Available in both **Expert** and **Enhanced** editions of **IDEA StatiCa Concrete and Prestressing**.

### SLS checks of prestressed concrete discontinuity regions

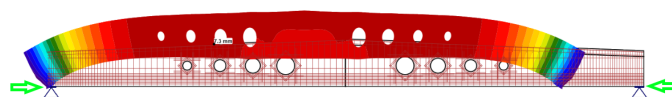

Is it your daily job to design and assess prestressed beams, walls with openings, dapped end beams, or even beams with haunches, but you struggle with the crack width or deflection? In IDEA StatiCa Detail, you can perform SLS checks of prestressed concrete discontinuity regions.

Since version 22.1, you can get complete results on a prestressed concrete element not only for ultimate limit state check but also for all serviceable limit state checks, such as stress limitation, crack width, and, last but not least, deflection code-check.

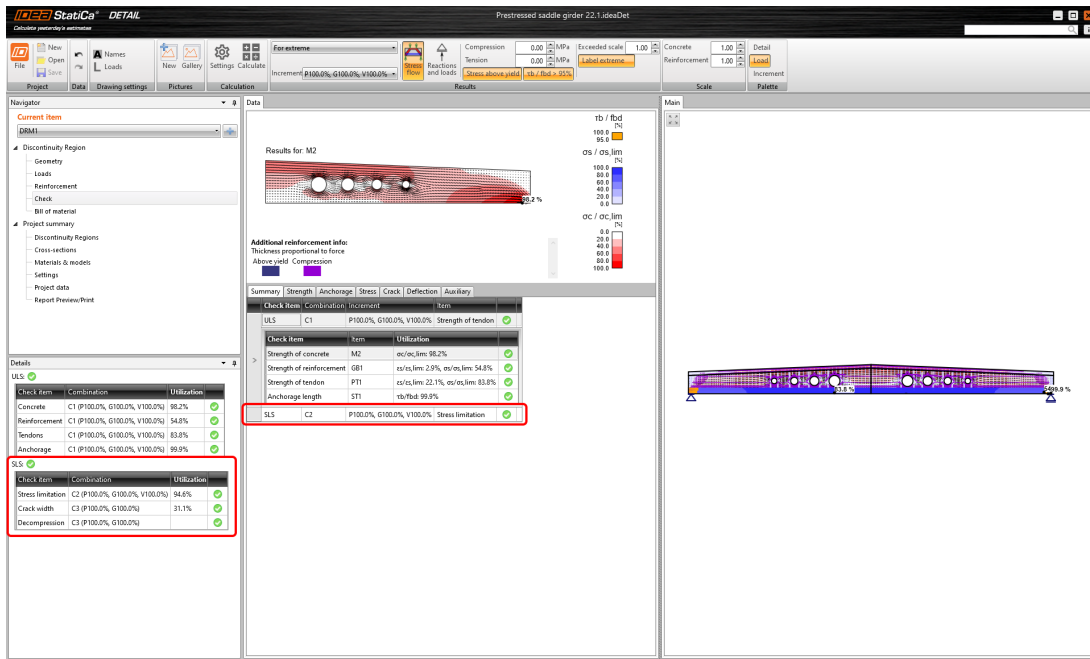

The only thing you need to do is to set characteristic and quasi-permanent combinations for the serviceable limit state checks. The application will do the rest automatically, and you will receive corresponding results. Just like you are used to doing it in modeling the reinforced concrete element.

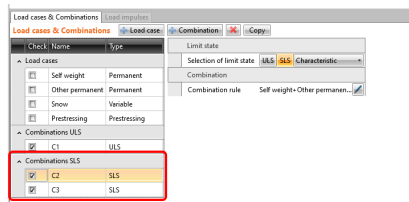

## Stress limitation check

The stress limitation check is done automatically for concrete, reinforcement, and prestressing tendons. The tendon check is done according to Eurocode (EN) for the characteristic combination.

The screenshot shows the 'Summary' tab in the software. The 'Results presented for:' section is expanded to show the following results:

Reinforcement	X [m]	Y [m]	Z [m]	Critical check	Y <sub>sp</sub> [MPa]	σ <sub>lim</sub> [MPa]	σ <sub>sp</sub> / σ <sub>lim</sub> [%]
PT1	9.92	-0.83	7.25	1302.3	1395.0	97.5	✓
PT2	9.99	-0.76	7.25	1242.0	1395.0	96.2	✓
PT3	10.00	-0.71	7.25	1235.0	1395.0	95.0	✓
PT4	9.92	-0.68	7.25	1308.3	1395.0	93.8	✓
PT5	9.76	-0.63	7.25	1291.9	1395.0	92.6	✓
PT6	9.92	-0.58	7.25	1275.7	1395.0	91.5	✓

When modeling post-tensioned tendons, it is possible to turn on the possibility of having a partially loaded area at the anchoring zone. In that case, according to Eurocode, you can neglect the concrete check in the above support area from the stress limitation check.

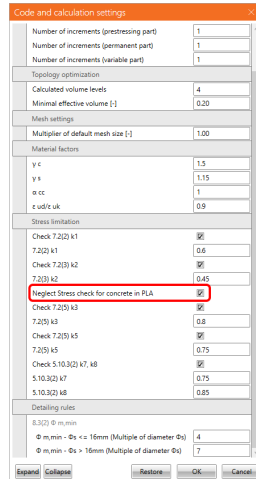

## Crack width check

Since version 22.1, the calculation of the crack width for prestressed elements has been extended with the decompression check. The main assumption is that every modeled tendon is in the compressed area of the concrete. When concrete embedding the tendon is in tension, the tendon is presented with a red (orange) color in a 2D scene. Also, the nonconformity warning with extreme strain value is shown in the summary results table.

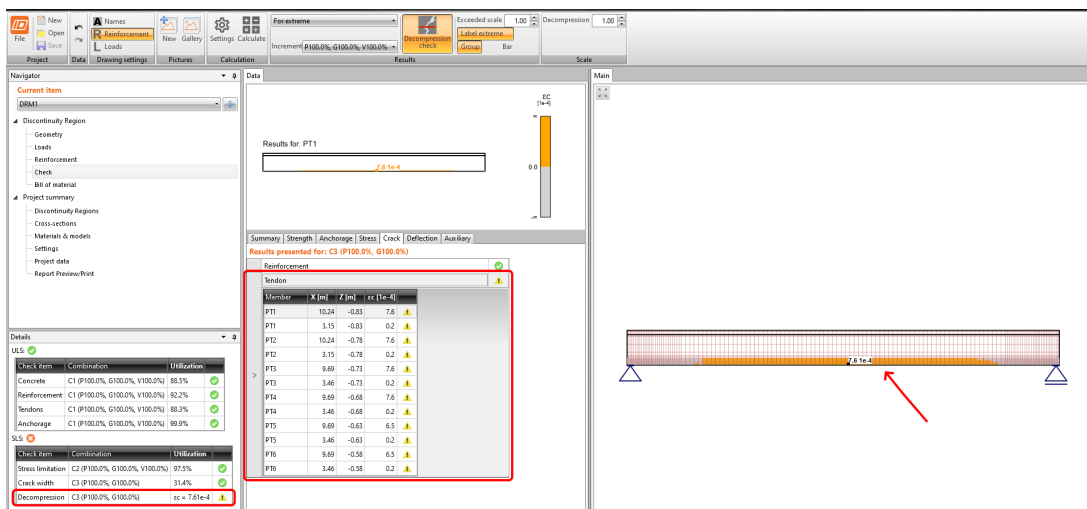

For all of the SLS checks mentioned above, the input of two different creep coefficients has been implemented. The creep coefficient is defined by the user in the Materials and constitutive model table in concrete grade properties. It is possible to define the creep coefficient for prestressing and self-weight and for superimposed dead load separately. The input is then used for evaluating the long-term effects.

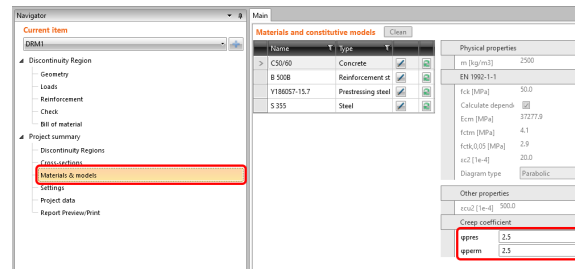

Available in the **Enhanced** edition of **IDEA StatiCa Prestressing**.

## Detail: Mesh refinement around openings and above supports

Version 22.0

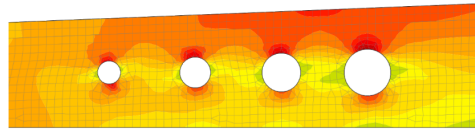

Version 22.1

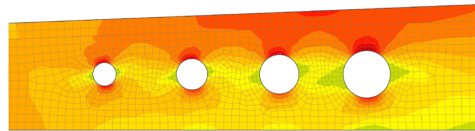

Making the structural engineers' work as easy and time-saving as possible is essential. To code-check structures quickly and safely is one of their main goals. When working on the new version, we focused on the mesh to make the calculation faster and results more accurate than ever before.

## Improved mesh quality around openings

Defining the mesh is very important and accounts for approximately 10 % of the overall analysis. The software creates it automatically. The new mesh implementation leads to reducing the triangular finite elements around circular openings, so you get higher mesh quality and refined finite elements in the surrounding area. And because sometimes it is necessary to create a model of a large structure with small openings, the new mesh is automatically refined around the openings while making the finite elements bigger on the rest of the model. So the analysis is faster and more stable than in the previous versions.

Version 22.0

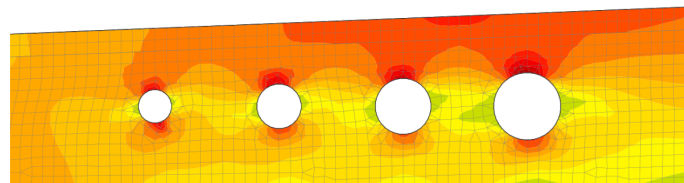

Version 22.1

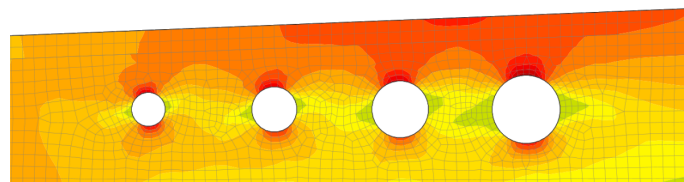

## Improved mesh quality above supports

Another part of the discontinuity region affected by the advanced mesh refinement is the area above the support. In version 22.1, a new condition of a minimum of four finite elements above support leads to better stress-state definition hence even more accurate results with limitation of inaccuracies in the strength check and reaction calculation.

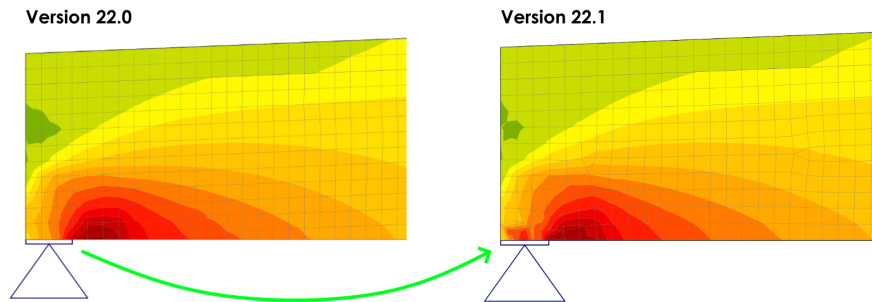

Available in **Enhanced** edition of **IDEA StatiCa Concrete and Prestressing**.

## Nonlinear analysis of tapered members

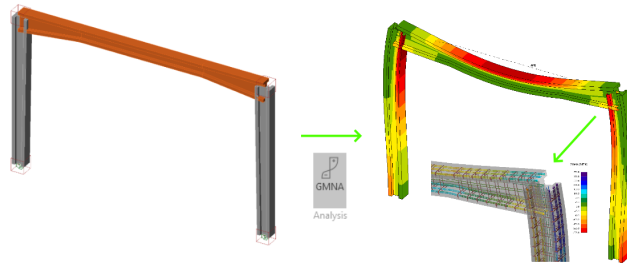

Your wait is over. If you are a structural engineer who deals with concrete structures where tapered beams, columns, or whole frames are a necessity, then we have a solution just for you. Let us introduce you to brand new functionality in the IDEA StatiCa Member application.

Assessment of tapered structures can become a piece of cake. How? Very easily - with the help of the IDEA StatiCa Member application.

A new property of analyzed members was implemented. You can decide whether you are modeling prismatic or tapered members.

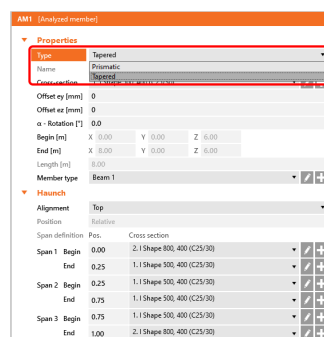

The geometry of haunches can be set using the relative coordinates. And you can have as many haunches as you need. Just click on the plus button and add a new one. Then specify the cross-section of the haunch and assign it to the correct edge. On top of that, the haunch can be aligned to the member's top edge, bottom edge, or center.

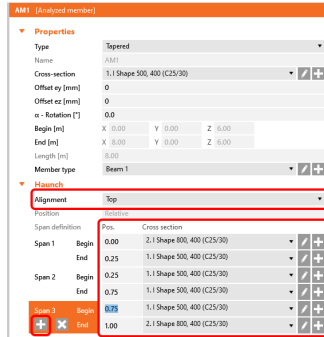

Reinforcement can be specified in two ways. The first one is with the help of rebar assembly using the editor that you may know from our other concrete applications. You must define the reinforcement for each part of the member - tapered and prismatic.

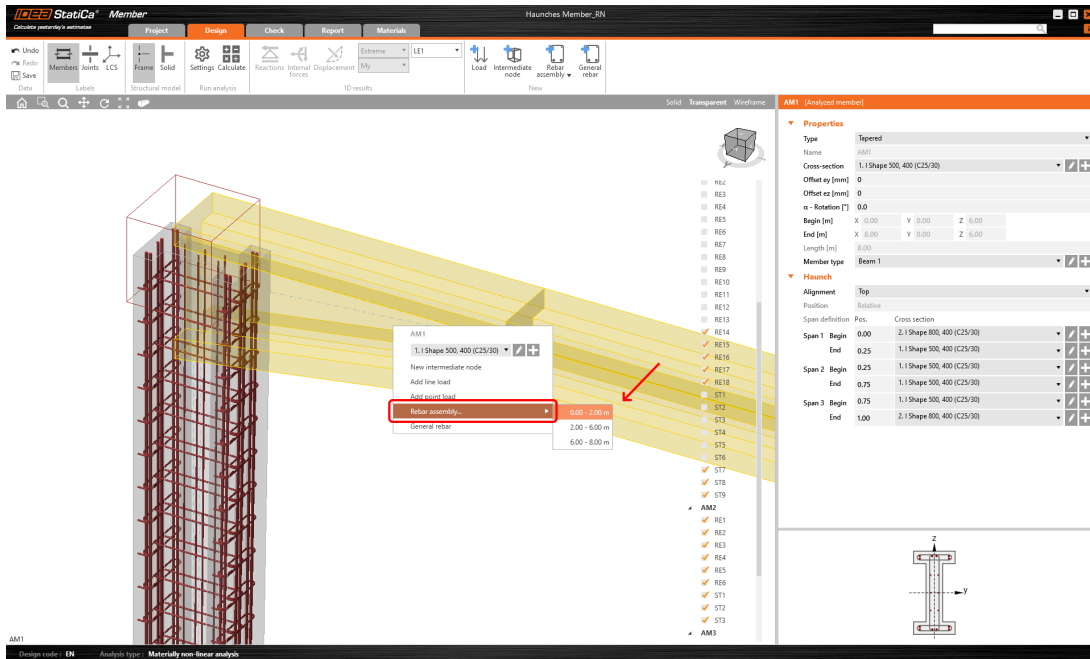

The second is via option "General rebar." In that case, you can model, e.g., continuous rebar along the length of the concrete member using coordinates.

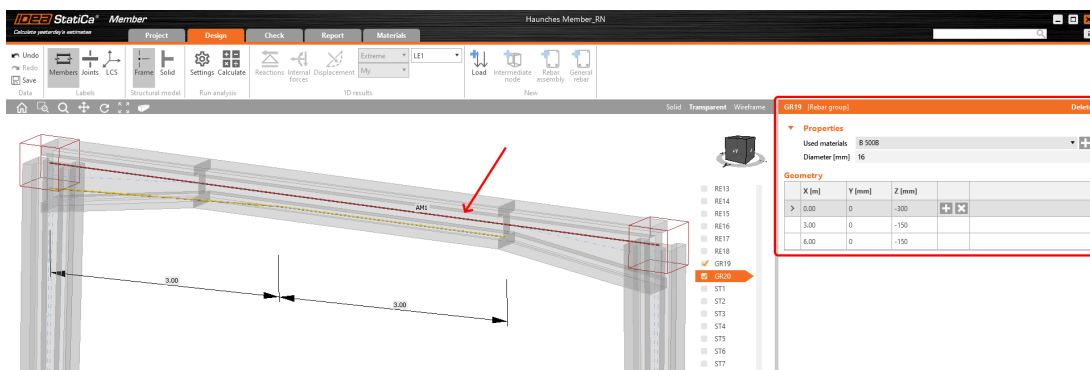

When you are done modeling, nothing stops you from running the analysis. It is up to you whether you run the linear analysis (LA) first or jump straight to geometrically and materially nonlinear analysis (GMNA).

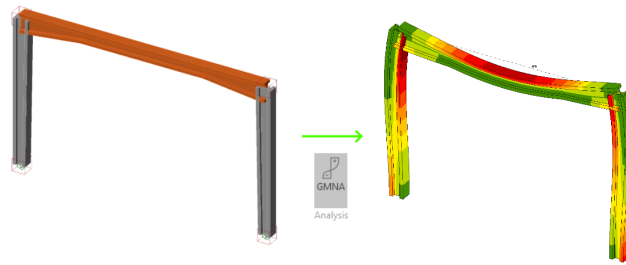

Be aware that GMNA doesn't include the shear check. For such an assessment, the linear analysis must be run. The thermal analysis is not supported for tapered members.

Available in both **Expert** and **Enhanced** editions of **IDEA StatiCa Concrete and Prestressing**.

## GMNIA solver extended to shear and torsion effects

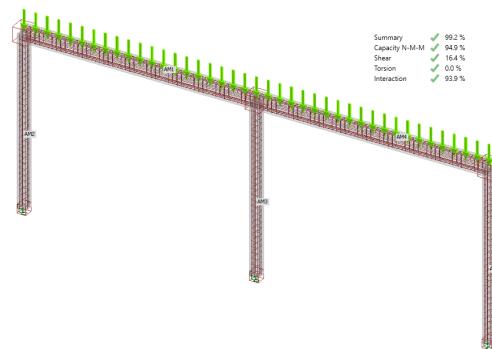

A new code-based method for calculating stresses due to shear and torsion effects has been implemented into the IDEA StatiCa Member app. You don't need to separate each member of the frame anymore. Just model or import the whole structure and deal with the assessment in the Member application.

## Shear and torsion code-based check

We want to enable our customers to work quickly and efficiently. So that engineers do not have to divide the structure in a complicated way and have all the checks in one place, we have implemented a simplified method for calculating the stresses in longitudinal reinforcement due to shear and torsion in IDEA StatiCa Member.

The method is based on the principle of nonlinear increments. During the analysis, the solver is automatically adding the percentual increments of the load effects to the longitudinal reinforcement.

Additional force in the longitudinal reinforcement due to shear is determined according to the following formula:

$$\Delta F_{sd} = V_{ed} (\cot \theta - \cot \alpha)$$

For evaluating strain increment due to shear, the formula below was used:



$$\Delta\epsilon_v = \frac{\Delta F_{td}}{\sum_{i=1}^{n_{s,F}} A_{s,i,V} \cdot E_{s,i,V} + \sum_{i=1}^{n_{s,T}} A_{s,i,V} \cdot E_{s,i,V}}$$

And for the determination of the strain increment due to torsion, this formula:

$$\Delta\epsilon_v = \frac{T_{ed} \cdot U_t}{2A_s \cdot \sum_{i=1}^{n_{s,T}} A_{s,i,T} \cdot E_{s,i,T}} \cot \theta$$

Be aware that GMNA doesn't include the shear check. For such an assessment, the linear analysis must be run.

## Tension stiffening effect

Tension stiffening effect - method for the calculation of the reinforcement ratio, which you may know from the IDEA StatiCa Detail application, has been also implemented in the IDEA StatiCa Member application. The method uses a stress-strain diagram for reinforcement with the tension stiffening effect for GMNA analysis.

The main assumptions of the tension stiffening effect are:

- It does not affect strength.
- Increase the stiffness = reduce the deflections.
- Reduction of the ductility of the structure.

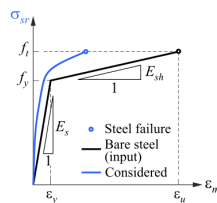

Available in both **Expert** and **Enhanced** editions of **IDEA StatiCa Concrete and Prestressing**.

## Download & try all new features of IDEA StatiCa 22.1

[DOWNLOAD IDEA STATICA 22.1 →](#)

## News for BIM links

### Checkbot improvements in 3D Scene

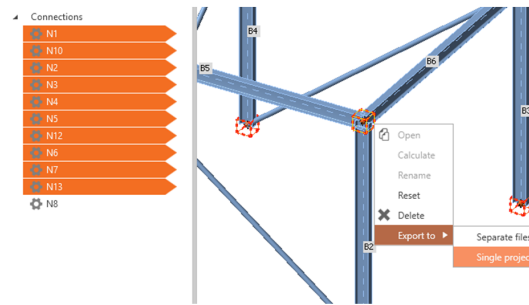

The Checkbot app is one of the crucial tools for seamless workflows with 3rd party applications. It's 3D graphic scene is the best place for quick check whether all the structural members came correctly. Let's take a look on improvements in version 22.1.

For more intuitive work, version 22.1 brings new possibilities of how to select the structural components. The virtual cubes representing the particular connections are now active in 3D scene and multiselection is enabled for both, component list as well for the 3D scene.

## Enhancements in 22.1:

- Multiselect of connection cubes in the scene
- Right-click the context menu for connections in the 3D scene
- Esc to cancel selection

Available in both **Expert** and **Enhanced** editions of **IDEA StatiCa Steel**.

## New BimApi workflow

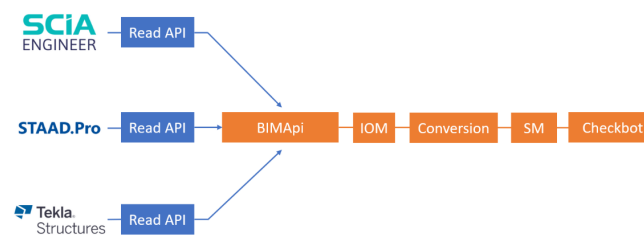

The BIM links are one of the most powerful abilities of the IDEA StatiCa environment. In every new version, we are closer to seamless and errorless communication with the 3rd party applications. In version IDEA StatiCa 22.1, the step is bigger than it could look at first glance.

Our developers changed the way how we bring information from other structural analysis software to our Checkbot app. Until version IDEA StatiCa 22.1, it was quite a different story for every vendor's app we tried to communicate with. It meant, that anybody willing to build and use the IDEA BIM link had to understand the whole process and there was a big space for bugs and errors.

From version IDEA StatiCa 22.1 we use a tool called BimApi. That's the only part of the BIM communication process that the vendor's developers have to understand and adjust their part of the code to.

### Enhancements for better BIM interconnections:

- Faster integration (single click)
- Better cross-section recognition
- Progress bar for imports

### Messaging for links converted to BimApi

- Import or sync progress shown for three stages (waiting for 3rd party app, reading IOM, generating connections)
- Option to cancel the import
- SAF, SCIA, RFEM5, RSTAB8, STAAD.Pro, Tekla Structures

Available in both **Expert** and **Enhanced** editions of **IDEA StatiCa Steel**.

## Download & try all new features of IDEA StatiCa 22.1

DOWNLOAD IDEA STATICA 22.1 →

## Licensing & All applications

### License usage analytics in the User Portal

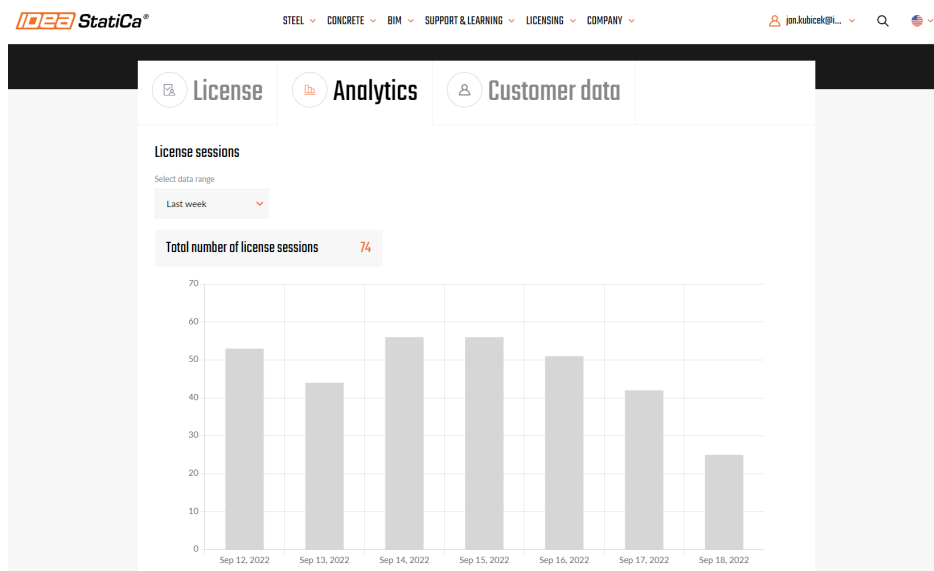

Every customer can investigate, how his or her IDEA StatiCa licenses are used. In the User portal, the brand new category Analytics was added. Overviews displayed here will help to recognize how often the IDEA products are used within the office.

# Analytics overviews:

## Number of License sessions

License session is counted always when any license seat is occupied by running whatever IDEA StatiCa app.

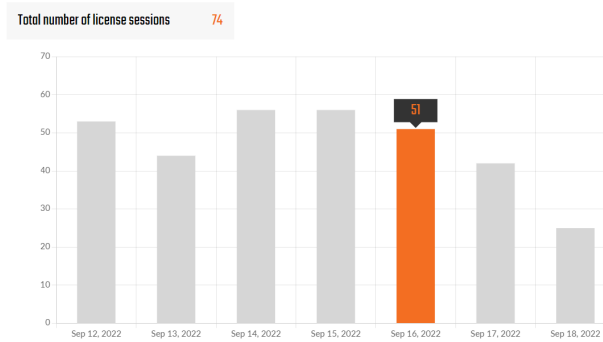

The number of License sessions depends on how many Products the user has activated in the License setting:

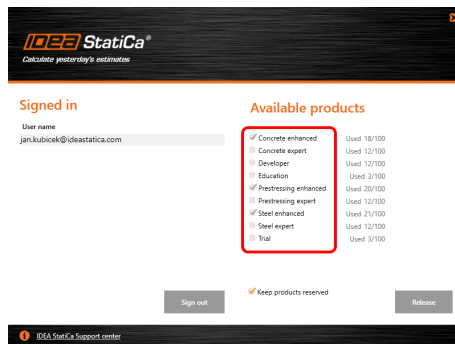

(In this example, 4 license sessions would be counted by starting any IDEA StatiCa app by this particular user)

The user always has an option to Keep the products reserved for a longer time period which can be set in the range of 1-500 hours after closing the app. It can be useful e.g. for planned work without an internet connection.

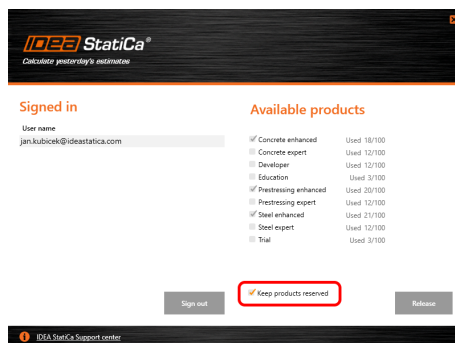

With the option 'Keep products reserved' turned on, the license session will end by running out of the 'Check interval' time period (set in the User portal license setting).



Otherwise, with the option 'Keep products reserved' turned off, the license session will end by closing the last active IDEA StatiCa app.

The check interval is set to 72 hours by default and can be edited by the license admin in the User Portal.

## Number of License clashes

Clash is counted always when a user attempts to use a product while all the purchased license seats are occupied by other users.

The user can review the number of clashes in the history to be able to decide whether purchasing another license seat could help the users to be productive without waiting for others to release the seat.

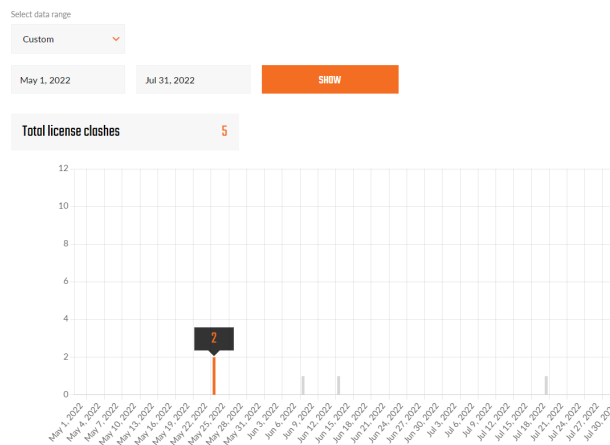

Available in the IDEA StatiCa [User Portal](#).

## All applications: Search box

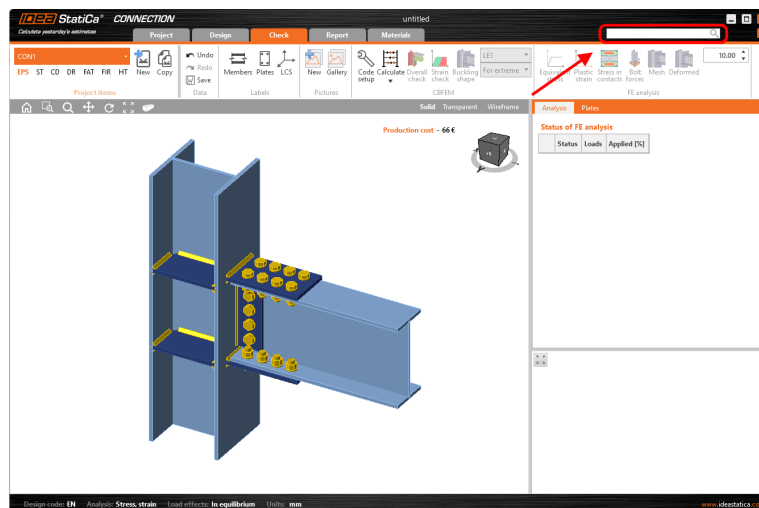

A new step in speeding up our support to the users. Our Search box embedded directly into the application's top bar will help with immediate technical help during the work.

## How it works:

- Simply input the desired keyword or sentence into the search box.

- Press enter.
- You will be automatically redirected to the IDEA StatiCa web page with the relevant results from the Support Center content.
- The language mutation of the web page will be selected according to the language set for the application
- In case the language mutation doesn't exist on the web, the results in the default English language will be displayed.
- This feature works only if the user is connected to the internet.

Available in both **Expert** and **Enhanced** editions of **IDEA StatiCa Steel** and **IDEA StatiCa Concrete**.

## Solved incidents

See the current [list of solved incidents](#) reported by our customers.

## Download & try all new features of IDEA StatiCa 22.1

[DOWNLOAD IDEA STATICA 22.1 →](#)